

TOTO

Head Office

TOTO Europe GmbH
Zollhof 2, 40221 Düsseldorf Germany
Tel:+49 (0)700 8686 0700
E-Mail: teu.information@toto.com

TOTO WASHLET

Instruction Manual

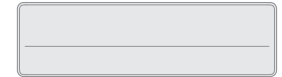

washlèt

TCF802E2G
TCF802EAG
TCF801EG
TCF801EAG

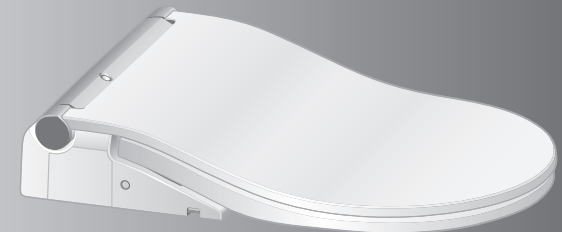

TCF804E2G
TCF803EG

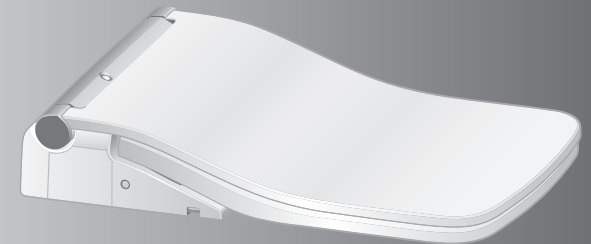

You are advised to record the following information to allow quick service.

Date of purchase :	Name of shop :
Date : year month day	
	Tel :

Thank you for your recent purchase of this product.
Please read the enclosed information to ensure the safe use of your product.
Be sure to read this Instruction Manual before using your product and keep it in a safe place for future reference.

Table of Contents

Introduction

Safety Precautions	4
Operational Precautions	8
Parts Names	10
Preparation	12
Using the Product for the First Time.....	12
How to turn off the product	14

Operation

Basic Operations	15
Mechanism of Auto Functions	15
Auto open / close.....	15
Auto bowl CLEAN	15
Deodorizer	15
Auto power deodorizer.....	15
Auto flushing.....	15
Auto wand CLEAN	16
Soft light	17
CLEAN indicator	17
Using the Remote Control	18
Stop.....	18
Rear washing.....	18
Rear soft washing	18
Front washing	18
Warm air drying	18
Water pressure adjustment	18
Wand position adjustment	18
Pulsating washing.....	19
Oscillating washing	19
Wand CLEAN	19
Power deodorizer.....	19
Full flush.....	19
Light flush	19
Opening and closing the toilet lid	19
Opening and closing the toilet seat	19
Personal setting	19
Low battery warning mark	19
Power ON/OFF button	20
Wand cleaning	20
Manual spray	20
Warm water temperature	20
Toilet seat temperature	20
Drying air temperature	20

Auto energy saver / Auto energy saver+	20
Timer energy saver	20
Auto open / close ON / OFF.....	20
Setting confirmation	20
Auto flushing ON /OFF.....	20
Temperature Adjustment	22
Warm water, Toilet seat, Drying	22
Changing Settings	24
Setting List	24
The energy saver features	26
How to Set.....	28
Auto energy saver.....	28
Auto energy saver+.....	28
Timer energy saver	29
Auto flushing.....	29
Auto flush delay	30
Auto flush lid closed.....	30
Auto open / close.....	32
Auto close delay	32
Auto open delay.....	33
Seat/lid	33
Auto wand CLEAN	34
Auto bowl CLEAN	34
Deodorizer.....	35
Auto power deodorizer	35
Soft light	36
Bowl light.....	36
CLEAN indicator	37
Beep sound	37
Pressure/position setting	38
Personal setting.....	38
Registering Personal Settings	39

Maintenance

Maintenance	40
Before maintenance	40
Main unit	41
Manual Spray	42
Wand.....	42
Wand cleaning	42
Deodorizing Filter	43
Gap between the Main Unit and Bowl Unit.....	44
Gap between the Main Unit and the Toilet Lid ...	46
Descaling Agent	48
Descaling	49
Descaling mode.....	50
Drain Plug with Water Supply Filter	54
Spray Nozzle	55

Reference

What to Do?	57
If the water does not flow due to a water service interruption	57
If you cannot operate with the remote control	57
Replacing the batteries	57
Freeze Damage Prevention	58
Long Periods of Disuse.....	59
How to drain the water.....	59
Resupplying the Water.....	61
How to remove the operation guide	61
Troubleshooting	62
Please check first	62
Rear Washing, Front Washing and Wand	63
Warm air drying	64
Flushing	64
Toilet Seat and Toilet Lid (Auto open/close) ...	65
Toilet Seat and Toilet Lid.....	67
Auto flush lid closed	67
Energy Saver.....	68
Deodorizer.....	68
Auto bowl CLEAN	69
Light	69
Others	69
Specifications	71
Safety Guidelines	72
Warranty	73
Important User Guidance Information	75

The available functions vary according to the part no.



Functions	Part No.*1	
	TCF802E2G TCF802EAG TCF804E2G	TCF801EG TCF801EAG TCF803EG
Remote control flushing	●	-
Auto flushing	●	-
Auto flush lid closed	●	-

The illustrations in the instruction manual may differ from the actual product.

*1 The part no. is on the toilet lid label. (→Page 10)

Safety Precautions

These precautions are important for safe usage. Be sure to follow them and use the product correctly. The following symbols are used to indicate important safety instructions for the use of the product.

Symbol	Meaning
 WARNING	May result in death or serious injury.
 CAUTION	May result in injury or property damage.

WARNING

Never disassemble, repair or alter.

Doing so may cause fire, electrical shock, overheating, short circuit or breakdown.

Do not use the product if a malfunction occurs.

In case of breakdown or other problems, be sure to cut off power, by flipping the power switch to OFF or switching the breaker on the distribution board to OFF, etc.

Close the water shutoff valve to stop water supply. Possible malfunctions:

- Water is leaking from a pipe or the main unit
- The product is cracked or broken.
- The product makes a strange noise or emits a strange odor.
- The product emits smoke.
- The product is abnormally hot.
- The toilet seat cushion is out of place.

Continued use after malfunction could cause a fire, electric shock, heat, short circuit, injury or water damage.

Do not use other water than allowed by the laws and ordinances of the region of use. Only Use potable water.

Do not use seawater or recycled water.

Doing so may cause irritation to the skin and malfunction.

Keep cigarettes and other open flames away from the product.

Failure to do so may cause fire.

Refrain from sitting on the seat for long periods.

It may cause low-temperature burns.

To prevent the following persons from getting a moderate temperature burn during use, other person should turn off the toilet seat heater.

- Young children, the aged and other users unable to set the temperature appropriately themselves.
- The ill, physically disabled and others who do not have freedom of movement.
- Those using any medicines that cause drowsiness (sleeping or cold medicine), those who have been drinking heavily, anyone severely fatigued and anyone else liable to fall asleep.

If the power cord is damaged, avoid danger by having the manufacturer's repair department or equivalent specialist replace it.

Turn the power OFF before maintenance or inspection.*1

Failure to do so may cause electrical shock or malfunction.

Always the power OFF before removing the main unit.*1

Failure to do so may cause a fire or electrical shock.

Do not cut the string that connects the main unit and base plate.

Doing so may cause fire, electrical shock, overheating, short circuit or breakdown.

When leaking battery fluid adheres to your body or clothes, wash it away with clean water.

The fluid may damage your eyes or skin.

WARNING

Do not install the product on moving vehicles such as wheeled vehicles or boats.

Doing so may cause fire, electric shock, short circuit or malfunction.

The toilet seat, toilet lid, main unit, or other parts may come loose and fall off, resulting in injury.

Do not use any power supply other than the one specified.

AC 220–240 V, 50 Hz

Doing so may cause fire or excessive heat.

This is an electrical product. Do not install it anywhere water is likely to get on the product or anywhere with humidity high enough that water is likely to form on the surface of this product. When using the product in a bathroom, install a fan or ventilation port and ensure good air flow through the bathroom.

Failure to do so may cause fire or electrical shock.

Always connect the product to the cold water supply.

Connecting to hot water supply may result in burns and equipment damage.

Do not stick a finger or anything else into the warm air outlet.

Do not place anything on the warm air outlet or drape clothes over it.

Doing so may cause burns, electrical shock or malfunction.

Preliminary studies in females suggest that overuse of continuous spraying can increase the possibility of vaginal mucosa drying and potential reduction in desirable microbial organisms. Although these studies have not been validated, please consult your healthcare provider for concerns regarding whether these circumstances may apply to you.

More importantly, if you are an individual suffering from any immune deficiency as a result of disease, chemotherapy, or other medical condition compromising the immune system you should consult your healthcare provider before use of this product.

*1 How to turn off the product (→Page 14)

Safety Precautions

CAUTION

Do not use the product if the main unit is unstable.

Doing so may cause the main unit to come loose and fall, resulting in injury. (If there is backlash in the main unit, consult the installer, seller, or TOTO customer service. See contact information on the back cover.)

If the product is damaged, do not touch the damaged section.

Doing so may cause electrical shock or injury. Replace it immediately.

Do not apply strong force, mechanical shock, step on or stand on the toilet seat, toilet lid or main unit. Also do not place any heavy object on the toilet seat, toilet lid or main unit. Do not sit on the toilet lid.

Doing so may cause cracking or cause the main unit to come loose and fall, resulting in injury. Doing so may damage the product and cause injury or water damage.

Do not lift up this product by the toilet seat or lid. Do not raise the toilet seat or lid while objects are resting on top of the unit.

Doing so may cause the main unit to come loose and fall, resulting in injury.

When maintaining the plastic parts (main unit etc.) or the water supply hose, use a pH neutral kitchen detergent diluted with water. Do not use any of the following.

Toilet cleaner, household cleaner, benzene, paint thinner, powdered cleanser or nylon scrubbing brush.

These items may damage or crack the plastic and cause injury or malfunction.

These items could damage the water supply hose and cause a water leak.

To prevent a sudden water leak, do not remove the Drain plug with water supply filter when the shutoff valve is open.

Doing so will cause water to spurt out. (→Refer to Page 54 for instructions on cleaning the Drain plug with water supply filter.)

Do not fold or crush the water supply hose; do not damage by cutting with a sharp object.

Doing so may cause water leaks.

Do not install the base plate, which is not attached.

Doing so may cause damage.

If a water leak should occur, always close the shutoff valve.

When the ambient temperature is likely to drop to 0 °C or lower, prevent damage to the pipes and hoses due to freezing.

Frozen water pipes could cause the main unit and the pipes to break, resulting in a water leak. Regulate the room temperature to prevent the pipes and hoses from freezing during cold months. Drain the water.

When not using the product for a long time, close the shutoff valve, drain the water from the main unit and water supply hose, and then turn the power OFF.*1

When using the product again, allow the product to refill with water first. Otherwise, the water in the tank might become contaminated and cause skin inflammation or other problems. (→Refer to Page 61 for instructions on replenishing the water.) Leaving the power on may cause fire or heat.

When installing the Drain plug with water supply filter, make sure that it is securely tightened in its proper position.

Failure to securely tighten it may cause a water leak.

CAUTION

If the bowl is clogged, turn the power OFF*1 and remove the clog.

If the "Auto flushing"² is activated, it would make the wastewater in the bowl unit overflow and may result in water damage.

Use commercially available tools that are made for unclogging the bowl unit to remove the clogging.

Push the main unit securely on to the base plate.

After pushing the main unit until a click sound is heard, pull it slightly toward you to make sure that the product does not detach.

Doing so may cause the main unit to come loose and fall, resulting in injury.

Make sure of the plus and minus signs on the batteries before inserting them.

Remove depleted batteries immediately.

When replacing the batteries:

- Replace both batteries with new ones.
- Use the same brand for both new batteries (any brand available).

Failure to do so may cause the batteries to leak fluid, generate heat, rupture, or ignite.

When the product is supposed not to be used for long time, remove the batteries from the remote control.

Failure to do so may cause the batteries to leak fluid.

This product is classified as Class I Equipment and must be grounded.

Install this equipment so that the electrical outlet and power breaker are accessible.

Use the new hose set included with this equipment. Do not reuse an old hose set.

*1 How to turn off the product (→Page 14)

*2 Only applies to toilets with an "Auto flushing" function.

Operational Precautions

For prevention of damage

Wipe plastic areas such as the main unit and remote control with a soft cloth tightly wrung out with water.

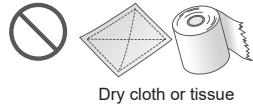

Do not lean against the toilet lid.



For prevention of malfunctions and failures

Turn the power OFF if there is a risk for lightning strike.*1

A toilet seat cover or a toilet lid cover cannot be used.

Otherwise, the seat sensor may not detect properly. Additionally, the toilet seat and lid may not open or close properly.



Do not urinate on the main unit, toilet seat or wand. Doing so may cause a failure or discoloration.

Do not apply strong forces to the control panel of the remote control.

When using a toilet cleaner to clean the toilet, rinse it off within 3 minutes and leave the toilet seat and toilet lid open.

If vapor from a toilet cleaner enters the main unit, it may cause a malfunction.

► Wipe off any cleaner that remains on the bowl unit.

Note: If "Auto flush lid closed" (→ Pages 30, 31) is turned ON and you use the remote control to flush the bowl unit, the toilet seat and lid close before flashing the bowl unit. After the bowl unit has been flushed, open the toilet seat and lid.

Do not use the product with the toilet lid removed.

Do not expose to direct sunlight.

Doing so may cause changes in color, irregular heated seat temperature or remote control malfunction. It may also cause product malfunction due to the change in temperature.

Use radios, etc. away from the product.

The product could cause interference with the radio signal.

If you use a booster seat for infants or a soft highchair, remove it after use.

Keeping it installed may prevent some of the functions from being used.

Do not apply force to the remote control.

This cause malfunction.

- To prevent the remote control from being dropped, set it in the hanger when you are not using it. Be careful not to expose it to water.

Do not place anything on the toilet seat, and do not press them with hands.

Doing so may activate the seat sensor, causing the floor to get wet if buttons on the remote control are touched and warm water comes out from the wand.

This product is intended for use up to a maximum height of 2,000 m above sea level.

For prevention of malfunctions

Do not block the body sensor or the remote control transmitter or receiver.

About the body sensors

Two types of body sensors are used.

Body sensor A detects changes in heat.

- Detection may be difficult when the room temperature exceeds 30 °C, such as in the summertime.
- When sunlight is directly on the sensor area or a heater is used in the bathroom, the sensor may detect incorrectly due to the heat, resulting in the automatic operation of functions such as auto lid opening and closing.
- When the bathroom door is open, the sensor may detect people who pass to the front or side of the toilet.

Body sensor B detects when someone stands in front of the toilet bowl.

- Body sensor B emits an infrared beam as shown in the figure. When someone moves into the line of this infrared beam, the sensor detects the person.
- * Detection by the sensor may be difficult when the toilet is used by someone small, such as a child.

Body sensor A
(Detects changes in heat)



Body sensor B
(Detects when someone stands near)



About the built-in seat sensor

When you sit on the toilet seat, the seat sensor turns ON, enabling you to use various features. (The deodorizer starts when the seat sensor makes a detection.)

Sit so your skin is in direct contact with the seat sensor.

The seat sensor may not detect properly if there is a seat cover or clothing. If you use the booster seat for infants, the seat sensor may not detect properly, resulting in the toilet lid closing automatically during use.

► Turn "Auto open / close" OFF before use.

Water droplets collecting on the seat sensor may cause the main unit to malfunction.

► Be sure to wipe off any water droplets on the sensor. Do not use items that cause damage, such as toilet paper. (→Page 41)

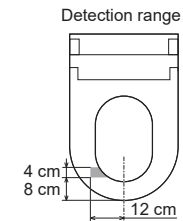

*1 How to turn off the product (→Page 14)

Parts Names

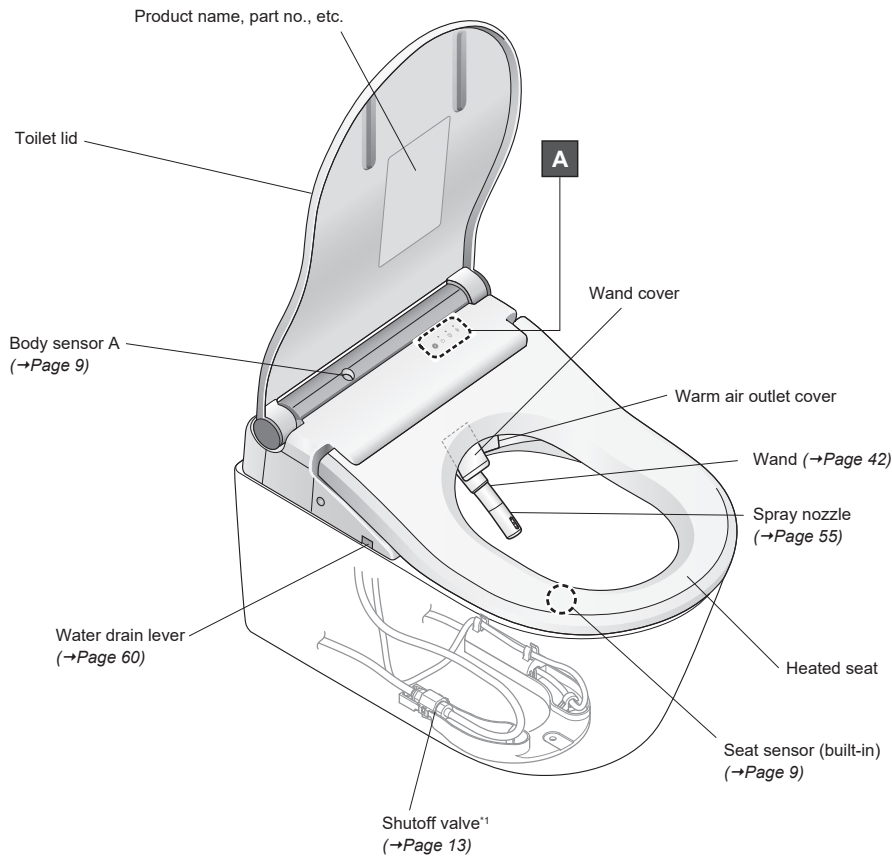

A: Main display

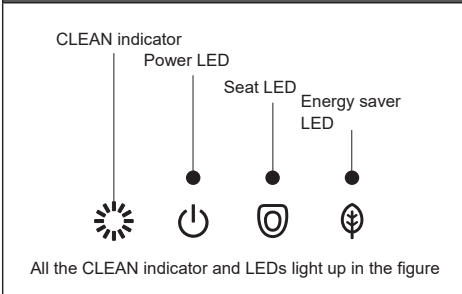

B: Left side of the main unit

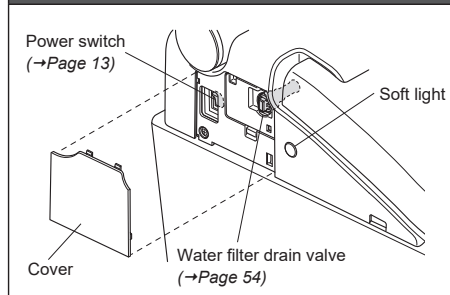

C: Right side of the main unit

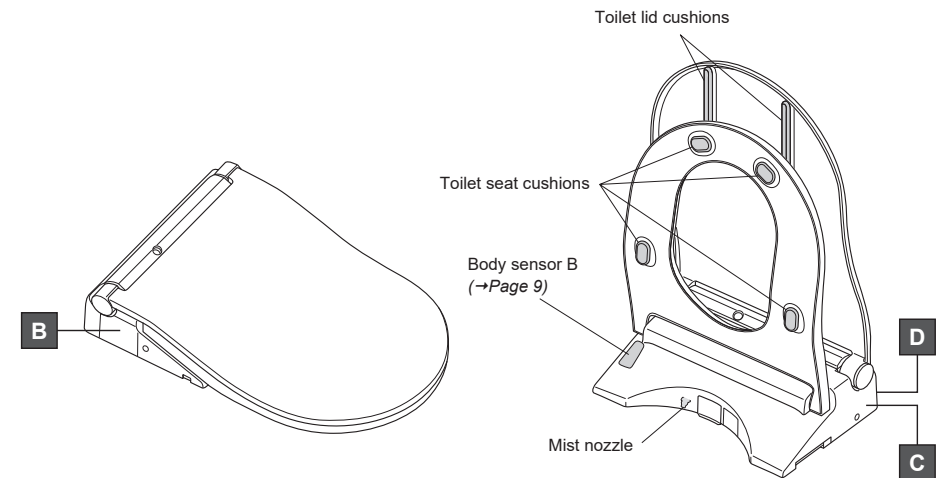
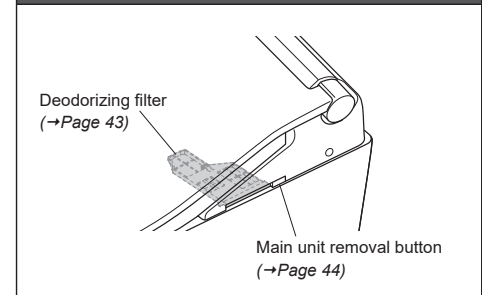

D: Rear side of the main unit

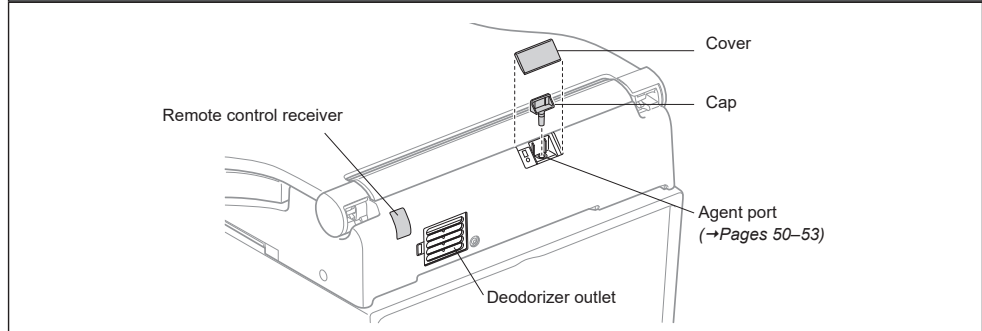

Descriptions in this manual are based on the illustration of TCF802E2G, TCF802EAG, TCF801EG, TCF801EAG. The toilet seat and the toilet lid shape varies by model.

*1 Diagram is for a wall-mounted bowl unit. Position of the shutoff valve differs on a floor-mounted bowl unit. (→Pages 14, 62)

Preparation

Using the Product for the First Time

1. Insert the battery

1.1 Remove the remote control from the hanger.

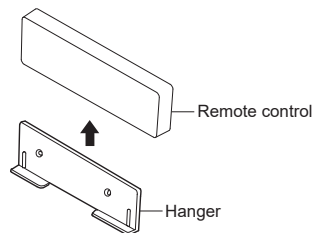

1.2 Open the battery cover and insert two AAA batteries.

After inserting batteries, close the battery cover.

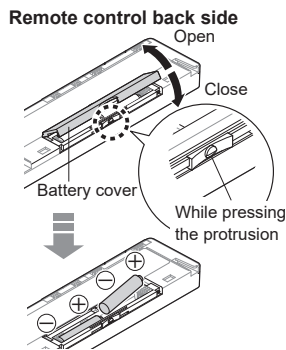

► When batteries are properly loaded, all the LEDs on the remote control light up for about 2 sec.

1.3 Mount the remote control in the hanger.

About the batteries

Use dry cell, alkaline batteries.

Be sure to follow "Safety Precautions" to prevent the batteries from rupturing or leaking fluid. (→Pages 4, 7)

If the remote control is secured to prevent theft

- 1) Hold the remote control and loosen the hanger hooks. (two locations, left and right)

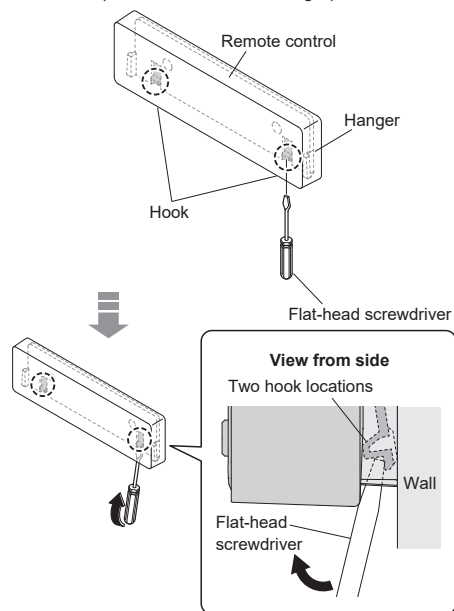

- 2) Remove the remote control from the hanger.

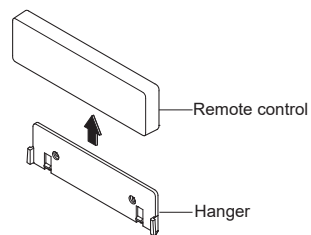

To secure the remote control again

Mount the remote control in the hanger.

2. Turn on the power

2.1 Switch the breaker on the distribution board to ON.

► The wand extends and then retracts.

2.2 Check the "Power" LED illuminates.

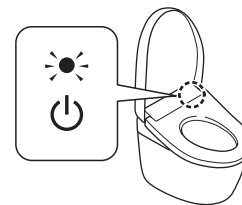

If the light is off

- 1) Remove the cover on the left side of the main unit, and flip the power switch to "ON".

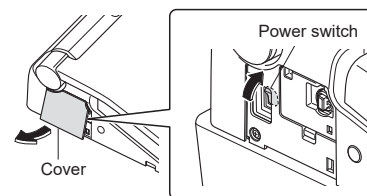

- 2) Reinstall the cover.

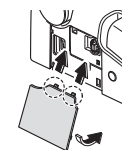

If the light is off, but the power switch is "ON"

Switch "Power" to "ON" using the remote control.

To operate from the back of remote control

- 1) Press "Power ON/OFF" button about 3 seconds or longer.

To operate from the front of remote control

Recommended if the remote control is secured to prevent theft, etc.

- 1) and Press and hold both the "Stop" button and "Water pressure adjustment +" button until the remote control LEDs are lit or flashing. (about 10 seconds)

Check



- 2) Press "Water pressure adjustment +" button.
- 3) Press "Water pressure adjustment -" button.
- 4) Press "Water pressure adjustment +" button.

3. Open the shutoff valve

3.1 Fully open the shutoff valve.

Wall-mounted bowl unit

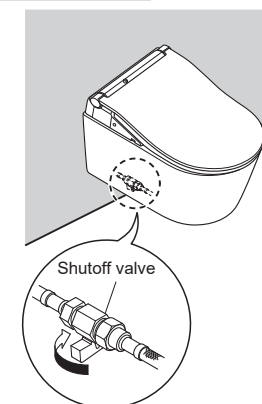

Preparation

Floor-mounted bowl unit

- 1) Remove the main unit. (→Page 44 Step 1, 2)
- 2) Fully open the shutoff valve.

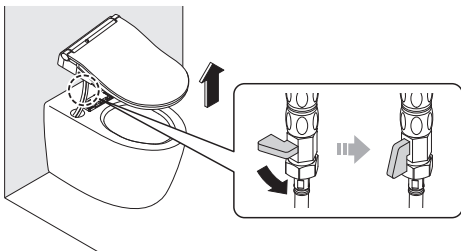

- 3) Mount the main unit. (→Page 45 Step 4, 5)

How to turn off the product

To turn the power "OFF"

- 1) Remove the cover on the left side of the main unit, and flip the power switch to "OFF".
 - ▶ The "Power" LED is unilluminated.

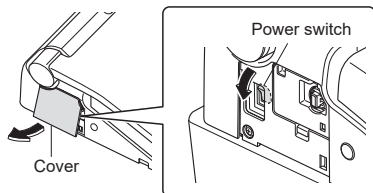

- 2) Reinstall the cover. (→Page 13)

Basic Operations

Mechanism of Auto Functions

"EWATER+" is used automatically to clean the wand and bowl unit.

1. As you approach



Auto open / close
Auto bowl CLEAN

Auto open / close

The toilet lid opens

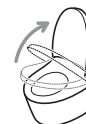

When the toilet is used in standing position

Open the toilet seat with the remote control.

Auto bowl CLEAN

PREMIST - Mist spray with water



The Bowl light lights up

A mist is automatically sprayed inside the bowl unit to make it more difficult for dirt to adhere.

2. As you sit*1



Deodorizer

Deodorizer

Starts the deodorizer



Removing odors inside the bowl unit.

Note: Deodorizing filter needs regular maintenance. (→Page 43)

3. As you stand up*1



Auto power deodorizer

Auto flushing

Auto wand CLEAN

Auto bowl CLEAN

Auto open / close

Auto power deodorizer

After about 10 seconds

Starts the auto power deodorizer



It stops about 60 seconds after you stand up from the toilet seat.

Auto flushing*3

After about 10 seconds

The toilet flushes*2



Note: The flushing varies depending on how long you sit on the toilet seat.

- Performs a light flush if the time is about 6 to 30 seconds.
- Performs a full flush if the time is about 30 seconds or longer.

*1 Water comes out from around the wand.

*2 You can change to the setting that closes the toilet lid before flushing the bowl unit. (→Page 30)

*3 Except TCF801EG, TCF801EAG, TCF803EG

Basic Operations

Auto wand CLEAN

Only when the washing functions are used.

After about 25 seconds

The wand extends to clean itself with "EWATER+" that comes out of the base^{*1}

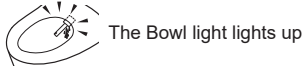

The Bowl light lights up

Note: "EWATER+" can also be used by pressing the remote control button. (→Page 19 "Wand CLEAN")

Auto bowl CLEAN

After cleaning the wand

After-mist "EWATER+" mist is sprayed on the bowl unit^{*1}



The Bowl light lights up

Note: If washing functions are not used, after-mist is performed approximately 25 seconds after standing up from the toilet seat.

Note: "EWATER+" can also be used by pressing the remote control button. (→Page 42 "Manual spray")

Auto open / close^{*2}

About 90 seconds after you stand up

The toilet lid closes^{*2}

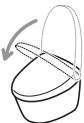

4. As you move away



Auto flushing

Auto open / close

When the toilet is used in standing position

Auto flushing^{*3}

About 3 seconds after the user has moved about 30 cm away from the bowl unit

The toilet flushes^{*2}



Performs a light flush.

Auto open / close

About 90 seconds after the user has moved about 30 cm away from the bowl unit

The toilet lid and toilet seat close^{*4}



Operation under the default settings is described in "Mechanism of Auto Functions".

These mechanisms be changed. (→Pages 24–39 "Changing Settings")

What is meant by "EWATER+" ?

This water containing hypochlorous acid generated from chloride ions in tap water, is widely used for cleaning and disinfecting items such as food, utensils and baby bottles.

- Well water may not deliver the required effect. (Because the level of chloride ions is low.)
- "EWATER+" helps to minimize dirty surfaces, but does not eliminate the need to clean completely.
- The effect and duration vary depending on the usage environment and conditions.

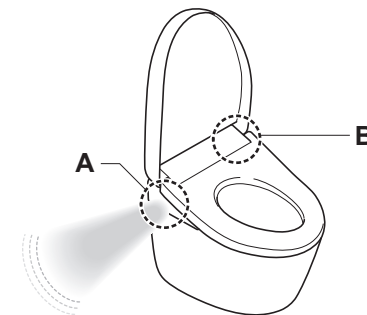

A Soft light

Lighting up the inside of the bathroom with a soft light.

It lights up as you approach the bowl unit and goes off after you move away from the unit and a certain time has passed.

Note: You can turn "Soft light" ON or OFF. (→Page 36)

B CLEAN indicator

Lights to show that the "Auto bowl CLEAN", "Deodorizer", "Auto wand CLEAN", and "Manual spray" functions are operating.

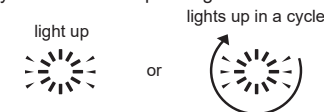

(Lights only when the toilet seat is not in-use)^{*5}

Note: You can turn "CLEAN indicator" ON or OFF. (→Page 37)

*1 If the washing function (Rear washing and Front washing etc.) is not used for about 8 hours, the following operations will occur.

•Auto wand CLEAN: The wand is cleaned automatically and water comes out from around the wand.

•Auto bowl CLEAN: Mist is sprayed on the bowl unit automatically.

*2 You can change to the setting that closes the toilet lid before flushing the bowl unit. (→Page 30)

*3 Except TCF801EG, TCF801EAG, TCF803EG

*4 When you do not sit on the toilet seat, or when you sit on it or stand in front of the bowl unit briefly, it takes about 5 minutes before the lid close automatically.

*5 Except "Manual spray"

Basic Operations

Using the Remote Control

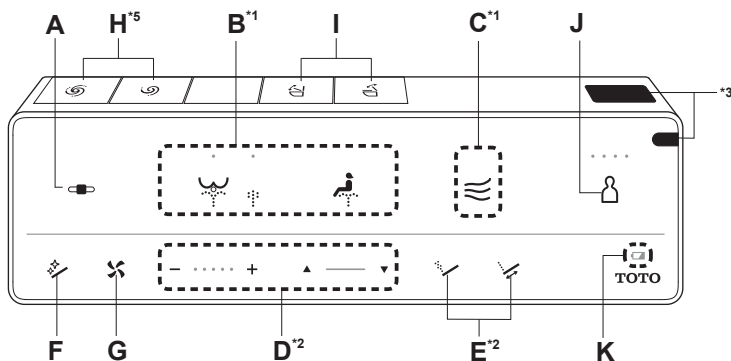

Operate the controls on the remote control; a beep sounds when the main unit receives the signal.

A **Stop**
Stops the B or D operation.

B **Rear washing**
Washes your rear.
 Rear soft washing
Washes your rear with mild water pressure.

The setting changes between and each time the is pressed.

C **Front washing**
Serves as a bidet for ladies.

C **Warm air drying**
Dries your rear.

D **Water pressure adjustment**
You can adjust the water pressure to one of five levels.
[-] Softer, [+] Stronger
After you press the "Water pressure adjustment" button, the set position will light for 10 seconds.

Attention	
If the water pressure does not change when the water pressure adjustment button is pressed, perform descaling. (→Page 50)	

E **Wand position adjustment**
You can adjust the washing position to 5 different points between the front and the rear, using the [] and [] buttons.

Once use of the remote control is finished, the settings will return to the initial setting (3rd position) after a while, not exceeding a maximum of 5 minutes.

If you do not want to return to 3rd position (→Page 38)

Note: *Sitting back on the toilet seat makes it easier to adjust the wand position and to reduce splashing.*

E **Pulsating washing**
Washes with the water pressure pulsating between soft and strong.

E **Oscillating washing**
The wand moves back and forth to washes your rear thoroughly.

Note: *Sitting back on the toilet seat makes it easier to adjust the wand position and to reduce splashing.*

F **Wand CLEAN**
Cleans the wand with "EWATER+"*6.

After wand cleaning, water comes out from around the wand.

Note: *This function will operate automatically after using the washing functions (Rear washing, Front washing, etc.). (→Pages 16, 34 "Auto wand CLEAN")*

Note: *To clean the wand with it extended. (→Page 42 "Wand cleaning")*

G **Power deodorizer**
Press the button to increase suction power and remove odor.
Cannot be used unless you are seated on the toilet seat.
Stops automatically in 60 seconds if left running.

H **Flushing***5
 Full flush*4
Performs a full flush.
 Light flush*4
Performs a light flush.

I **Opening and closing the toilet lid**
Opens and closes the toilet lid.
 Opening and closing the toilet seat
Opens and closes the toilet seat.

J **Personal setting**
Up to four people can register their preferred "Water pressure", "Wand position" and "Warm water temperature" settings. (→Pages 38, 39)

To use

1) Press the button to turn on the LED for the location of your setting.

- ○ ○ ○ Register 1
- ● ○ ○ Register 2
- ● ● ○ Register 3
- ● ● ● Register 4

2) Press the wash button you want to use ("Rear washing", etc.)

K **Low battery warning mark**
(→Page 57)

*1 This cannot be used if the seat sensor is not working. Sit so your skin is in direct contact with the seat sensor. (→Page 9)

*2 While using B, these buttons and their functions can be operated.

*3 Remote control transmitter.

*4 You can change to the setting that closes the toilet lid before flushing the bowl unit. (→Page 30)

*5 Except TCF801EG, TCF801EAG, TCF803EG

*6 What is meant by "EWATER+" ? (→Page 17)

Basic Operations

Using the Remote Control (Continued)

Remote control back side

How to remove the remote control (→Page 12)

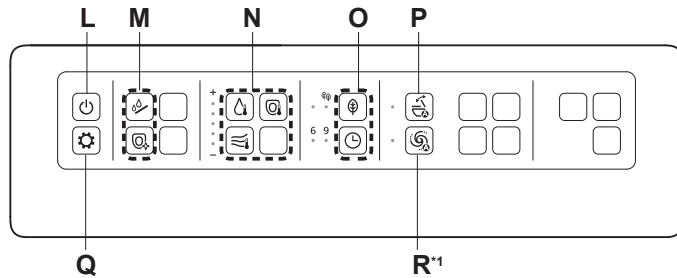

Operate the controls on the remote control; a beep sounds when the main unit receives the signal.

This section is an overview of the settings that can be configured with the remote control. See the corresponding pages for the detailed descriptions.

<p>L</p> <p>"Power ON/OFF" button Press and hold for 3 seconds or longer to turn washlet operation ON/OFF.</p> <p>▶ If the remote control is secured to prevent theft. (→Page 13 Step 2-2.2)</p>	<p>O</p> <p>Auto energy saver / Auto energy saver+</p> <p>Timer energy saver</p> <p>Saving energy (→Pages 28, 29)</p>
<p>M</p> <p>Wand cleaning (→Page 42)</p> <p>Manual spray "EWATER+"^{*2} mist is sprayed on the bowl unit.</p> <p><i>Note: It cannot be used when the wand is out or when you are sitting on the toilet seat.</i></p>	<p>P</p> <p>Auto open/close ON/OFF Changing Settings (→Page 32)</p>
<p>N</p> <p>Warm water temperature</p> <p>Toilet seat temperature</p> <p>Drying air temperature</p> <p>Adjust temperatures (→Pages 22, 23)</p>	<p>Q</p> <p>Setting confirmation The current setting can be discerned from the LEDs.</p> <p>R</p> <p>Auto flushing ON/OFF^{*1} Changing Settings (→Page 29)</p>

*1 Except TCF801EG, TCF801EAG, TCF803EG

*2 What is meant by "EWATER+" ? (→Page 17)

Temperature Adjustment

Warm Water, Toilet Seat, Drying

Five different temperature levels from high to low and "OFF" can be set.

Remote control back side

How to remove the remote control (→Page 12)

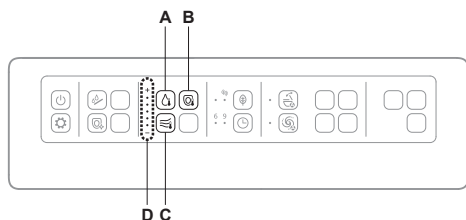

- A Warm water temperature button**
(When you want to adjust the warm water temperature)
- B Toilet seat temperature button**
(When you want to adjust the toilet seat temperature)
- C Drying air temperature button**
(When you want to adjust the drying air temperature)
- D Displaying the temperature level of the pressed button**

Adjusting the temperature

- 1.** Remove the remote control from the hanger.
 - ▶ If the remote control is secured to prevent theft. (→Page 12)
- 2.** Choose and press the button of the temperature that you want to set from the [ⓐ] ("Toilet seat temperature" button), [ⓑ] ("Warm water temperature" button) and [ⓒ] (Drying air temperature button).
 - ▶ The current temperature level appears.

- 3.** Press the button selected in step 2 repeatedly until a desired temperature level illuminates.

▶ The setting changes each time the button is pressed once

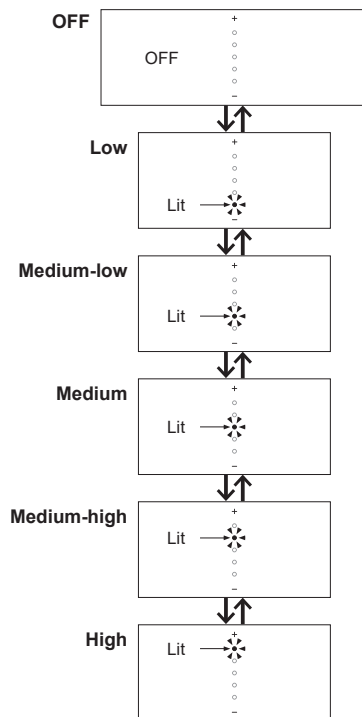

Settings complete

▶ When seat temperature is set, the seat LED illuminates.



Note: The "Drying" cannot be turned "OFF".
If the button is not pressed for about 10 seconds, the "Temperature adjustment" LED will go off, but the setting will be retained.
If the "Temperature adjustment" LED goes out before the setting is completed, start all over again at step 2.

- 4.** Mount the remote control in the hanger.
 - ▶ If the remote control is secured to prevent theft. (→Page 12)

To turn the warm water temperature*1 and toilet seat temperature "OFF"

- 1.** Remove the remote control from the hanger.
 - ▶ If the remote control is secured to prevent theft. (→Page 12)
- 2.** Select a temperature button you want to turn "OFF" from [ⓐ] ("Toilet seat temperature" button), [ⓑ] ("Warm water temperature" button) and press it.
 - ▶ The current temperature level appears.

- 3.** Press the button selected in step 2 repeatedly until the temperature level is set to "OFF".

▶ The setting changes each time the button is pressed once

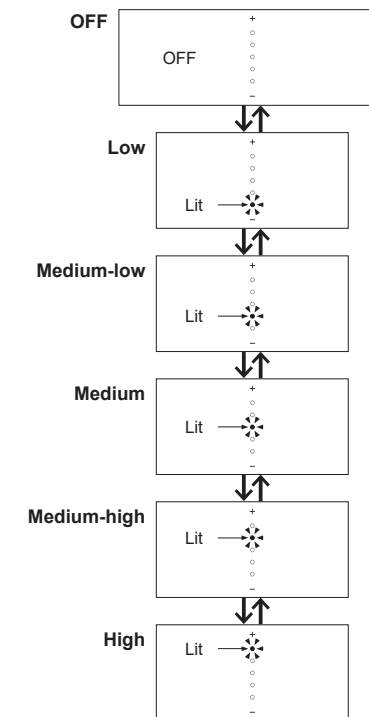

Settings complete

▶ When seat temperature is OFF, the seat LED is unilluminated.



Note: The "Drying" cannot be turned "OFF".

- 4.** Mount the remote control in the hanger.
 - ▶ If the remote control is secured to prevent theft. (→Page 12)

If adjusting the temperature does not warm up the toilet seat.
▶ Is the energy saver set to "ON"? (→Pages 26, 27)

*1 To prevent condensation, the water temperature does not drop below 20 °C even when set to "OFF".

Changing Settings

Setting List

Setting Types	Available Settings Bold: Initial settings	Applicable Models
Auto energy saver (→Page 28)	ON/OFF	All models
Auto energy saver+ (→Page 28)	ON/OFF	
Timer energy saver (→Page 29)	6H/9H/OFF	
Auto flushing (→Page 29)	ON/OFF	TCF802E2G TCF802EAG TCF804E2G
Auto flush delay (→Page 30)	SET 1/ SET 2 /SET 3	
Auto flush lid closed (→Page 30)	ON/OFF	
Auto open / close (→Page 32)	ON/OFF	All models
Auto close delay (→Page 32)	SET 1/ SET 2	
Auto open delay (→Page 33)	SET 1 /SET 2/SET 3	
Seat/lid (→Page 33)	Lid /Seat·Lid	
Auto wand CLEAN (→Page 34)	ON/OFF	
Auto bowl CLEAN (→Page 34)	ON/OFF	
Deodorizer (→Page 35)	ON/OFF	
Auto power deodorizer (→Page 35)	ON/OFF	
Soft light (→Page 36)	ON/OFF	
Bowl light (→Page 36)	ON/OFF	
CLEAN indicator (→Page 37)	ON/OFF	All models
Beep sound (→Page 37)	ON/OFF *1	
Pressure/position setting (→Page 38)	ON/OFF	
Personal setting (→Page 38)	ON/OFF	
Registering Personal Settings (→Page 39)	Register 1/Register 2 Register 3/Register 4	

Setting with buttons on the front of the remote control

Press the button indicated in step 1 for approximately 10 seconds or longer to enter setting mode.

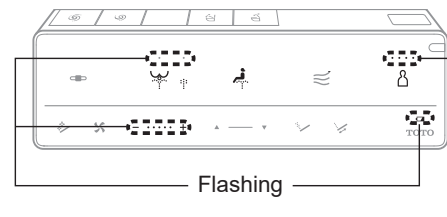

Check

■ Press "Stop" button about 10 seconds or longer.

■ and + Press "Stop" button and "Water pressure adjustment +" button at the same time about 10 seconds or longer.

Note: During setting, if the next button is not pressed within about 60 seconds, the light will stop flashing. If you fail to complete the setting, redo from the step 1.

Setting with buttons on the back of the remote control

Remote control back side
How to remove the remote control (→Page 12)

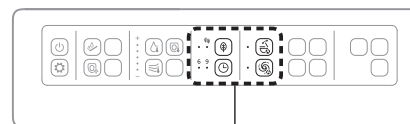

Use the LED to check settings.

▶ Setting buttons (→Pages 28–39)

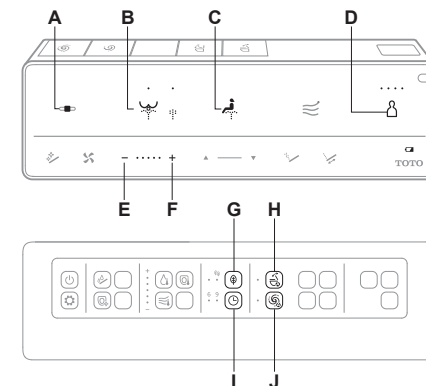

- A Stop button
- B Rear washing button
- C Front washing button
- D Personal setting button
- E Water pressure adjustment - button
- F Water pressure adjustment + button
- G Auto energy saver button
- H Auto open / close button
- I Timer energy saver button
- J Auto flushing button

*1 The beep sounds when settings are being changed, even if the beep noise is turned off. (except for "Pressure/position setting", "Personal setting")

Changing Settings

The energy saver features

"Auto energy saver", "Auto energy saver+" or "Timer energy saver" can be selected.

To save energy, the temperature of the toilet seat becomes low (or "OFF").

Note: Even if the energy saver is activated (with the toilet seat heater set to Low or OFF), the toilet seat will be temporarily heated when you sit on it. (To reach the set temperature, the toilet seat takes about 15 minutes.) The LED indication on the main display returns to the state for when the energy saver is on.

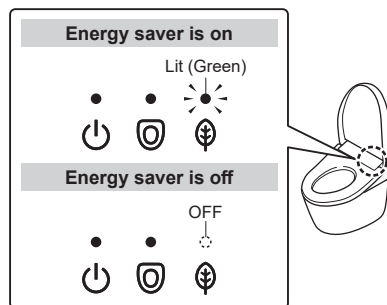

Auto energy saver

You want the product to save energy automatically

The product detects time periods with infrequent use and lowers the toilet seat temperature automatically.

It takes about 10 days for the product to determine the periods when it is used relatively less frequently.

When energy saver is in operation

Main display

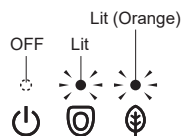

Toilet seat heater



Example

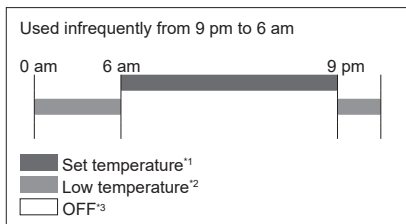

Auto energy saver+

You want to save more energy

In addition to the "Auto energy saver" feature, it automatically turns off the toilet seat heater during time periods when the toilet is not used.

When energy saver is in operation

Main display

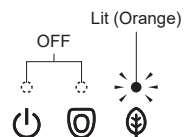

Toilet seat heater

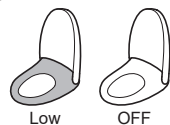

Example

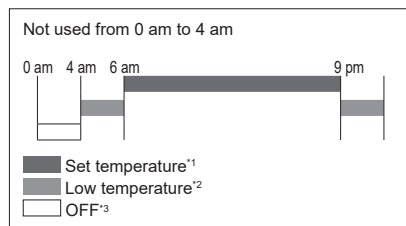

Timer energy saver

You want to save energy only for a preset duration of time. (6 hours, 9 hours)

Once the time is set, the toilet seat heater turns off automatically during the set time period every day.

When energy saver is in operation

Main display

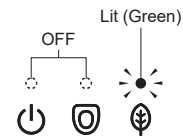

Toilet seat heater



Example

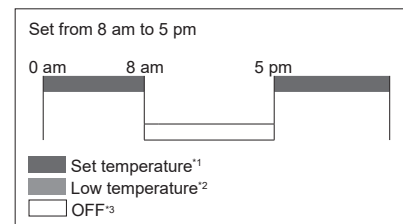

Timer energy saver and Auto energy saver / Auto energy saver+

You want to save the maximum amount of energy possible.

When both "Timer energy saver" and "Auto energy saver / Auto energy saver+" are set, "Auto energy saver / Auto energy saver+" operates when "Timer energy saver" is not operating.

When energy saver is in operation

Main display

During "Auto energy saver / Auto energy saver+":

▶ Same LED indication as "Auto energy saver / Auto energy saver+" (→Page 26)

During "Timer energy saver":

▶ Same LED indication as "Timer energy saver" (→See left)

Toilet seat heater

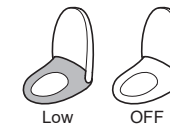

Example

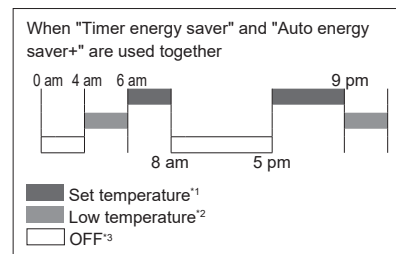

*1 The toilet seat temperature settings on pages 22, 23.

*2 The time period when the toilet seat heater is set to a "Low".

*3 The time period when the toilet seat heater is set to a "OFF"

Changing Settings

How to Set

Auto energy saver



Press "Auto energy saver" button.

► The setting changes each time the button is pressed once.

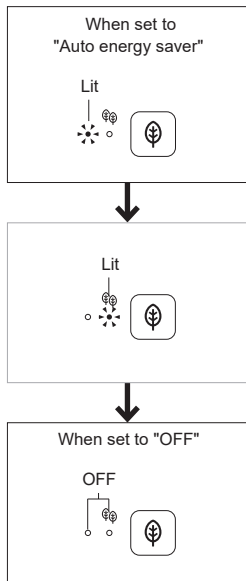

Settings complete

Auto energy saver+



Press "Auto energy saver+" button.

► The setting changes each time the button is pressed once.

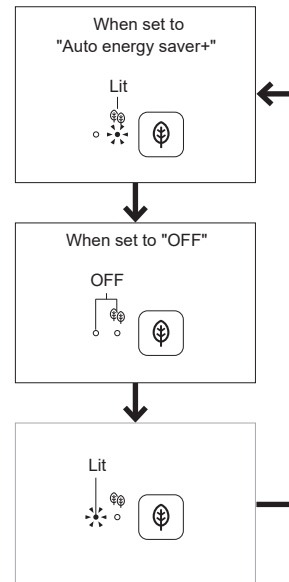

Settings complete

Timer energy saver

Set the "Timer energy saver" at the time you want to start it.

Example: To save energy from 1 am to 7 am (for 6 hours)



When the time of the day reaches 1:00 am at night, press "Timer energy saver" button.

Press the "Timer energy saver" button repeatedly until the "6" LED illuminates.

► The setting changes each time the button is pressed once.

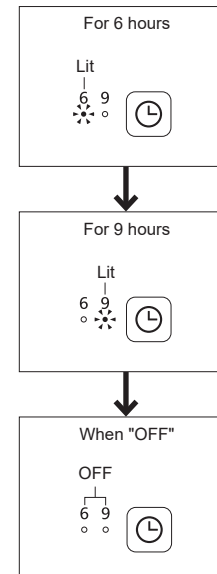

Settings complete

Auto flushing

Set whether or not to clean the bowl unit automatically



Press "Auto flushing" button.

► The setting changes each time the button is pressed once.

Set whether or not to clean the bowl unit automatically.

Check the "Auto flushing" LED (→Page 25)

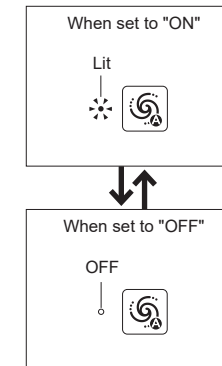

Settings complete

Changing Settings

Auto flush delay*1

Change the amount of time before the toilet flushes automatically

- 

Press "Stop" button until all LEDs on the remote control are lit or flashing.
(about 10 seconds)

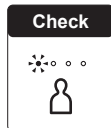

- 

Press "Rear washing" button.

- 

Press "Front washing" button.

- Choose and press the button of the item that you want to set.

Change the amount of time before the toilet flushes automatically.

When set to "SET 1"	When set to "SET 2"	When set to "SET 3"
Press "Water pressure adjustment -" button	Press "Rear washing" button	Press "Water pressure adjustment +" button
—		+
Short beeps	Long beep	Short beep

- SET 1 (Short) : After about 5 seconds
 SET 2 (Standard) : After about 10 seconds
 SET 3 (Long) : After about 15 seconds

Note: If "Auto flush lid closed" is turned ON, the toilet lid closes before flushing the bowl unit as above.

Settings complete

Auto flush lid closed

Set whether or not to close the toilet lid automatically before flushing the bowl unit

- 

Press "Stop" button until all LEDs on the remote control are lit or flashing.
(about 10 seconds)

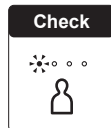



- 

Press "Rear washing" button.

- +

Press "Water pressure adjustment +" button.

- Choose and press the button of the item that you want to set.

When set to "ON" Press "Rear washing" button.  Short beep	When set to "OFF" Press "Front washing" button.  Long beep
--	---

Settings complete

About "Auto flush lid closed"...

About 10 seconds after you stand up or move away if you use the toilet in standing position, the toilet lid closes automatically before flushing the bowl unit.

Also, if you press the Flush buttons ("Full flush" or "Light flush") on the remote control, the toilet lid closes before flushing the bowl unit.

Using the toilet seat



Stand up

- The toilet lid closes in about 10 seconds.
 ► The toilet lid closes before flushing the bowl unit.

Using the toilet in standing position



Move away

- About 10 seconds after the user has moved about 30 cm away.
 ► The toilet seat and lid close before flushing the bowl unit.²

Using the flush buttons on the remote control

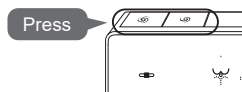

- The toilet lid closes.
 ► The toilet lid closes before flushing the bowl unit.

"Auto flush lid closed" does not work if "Auto flushing" and "Auto open / close" are set as below: (Except when using the flush buttons on the remote control)

	Auto flushing	Auto open / close
1)	OFF	ON
2)	ON	OFF
3)	OFF	OFF

- The toilet lid closes automatically but the bowl unit does not flush.
- The bowl unit flushes automatically but the toilet lid does not close.
- The toilet lid does not open / close and the bowl unit does not flush automatically.

Turn both "Auto flushing" and "Auto open / close" ON. (→Pages 29, 32)

Even if "Auto flushing" is turned ON, "Auto flush lid closed" may not work in some cases. For details, refer to "Auto flush lid closed" does not work" in "Troubleshooting". (→Page 67)

Note: You can change the length of time before water flushes after closing the toilet lid automatically to "SET 1", "SET 2", or "SET 3". (→Page 30)

If you get up slightly from the seat or sit leftward on the seat while seated on it, the seat sensor may not detect properly, which results in the toilet lid being closed and bowl unit being flushed. Sit down so that the seat sensor touches your skin directly. (→Page 9)

While using the toilet in standing position, the toilet lid may close and the bowl unit may be flushed. Stand straight in front of the bowl unit.

*1 The length of time specified for "Auto close delay (Auto flush lid closed)" if "Auto flush lid closed" is turned ON.

*2 The toilet seat and lid close in about 30 seconds and then the bowl unit flushes.

Changing Settings

Auto open / close

Set whether or not to open and close the toilet lid automatically



Press "Auto open / close" button.

- ▶ The setting changes each time the button is pressed once.

Set whether or not to open and close the toilet lid automatically.

Check the "Auto open/close" LED (→Page 25)

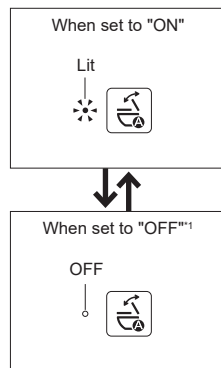

Settings complete

Auto close delay*1

Change the amount of time before the lid/seat closes automatically



Press "Stop" button until all LEDs on the remote control are lit or flashing. (about 10 seconds)

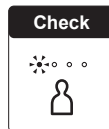

Press "Front washing" button.



Press "Rear washing" button.

4. Choose and press the button of the item that you want to set.

Change the amount of time before the lid/seat closes automatically.

When set to "SET 1" ² Press "Water pressure adjustment -" button. - Short beep	When set to "SET 2" Press "Water pressure adjustment +" button. + Long beep
--	--

SET 1 (Short) : After about 25 seconds

SET 2 (Standard) : After about 90 seconds

Settings complete

Auto open delay

Change the time period till automatic opening (After closing by hand or remote control.)



Press "Stop" button until all LEDs on the remote control are lit or flashing. (about 10 seconds)

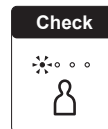

Press "Front washing" button.



Press "Water pressure adjustment +" button.

4. Choose and press the button of the item that you want to set.

Change the time period till automatic opening.

When set to "SET 1" Press "Rear washing" button. Long beep	When set to "SET 2" Press "Front washing" button. Short beep	When set to "SET 3" Press "Water pressure adjustment -" button. - Short beeps
--	--	--

SET 1 (Standard) : After about 15 seconds

SET 2 (Middle) : After about 30 seconds

SET 3 (Long) : After about 90 seconds

Settings complete

Seat/lid

Automatically open and close the toilet lid/ Automatically open and close the toilet seat and toilet lid



Press "Stop" button until all LEDs on the remote control are lit or flashing. (about 10 seconds)

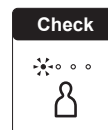

Press "Front washing" button.



Press "Water pressure adjustment -" button.

4. Choose and press the button of the item that you want to set.

Automatically open and close the toilet lid/ Automatically open and close the toilet seat and toilet lid.

When set to "Lid" Press "Rear washing" button. Long beep	When set to "Seat • lid" ³ Press "Front washing" button. Short beep
--	--

Settings complete

*1 If "Auto flush lid closed" is turned ON, you cannot use this setting to change the length of time before closing the toilet lid automatically. Configure the settings for "Auto flush delay". (→Page 30)

*2 When set to "SET 1 (Short)", the lid/seat does not open automatically for about 15 seconds after closing automatically.

*3 When "Seat and lid" are set to open automatically, pre-mist is not sprayed.

Changing Settings

Auto wand CLEAN

Set whether or not to clean the wand automatically

-  Press "Stop" button until all LEDs on the remote control are lit or flashing. (about 10 seconds)

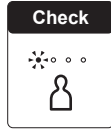

-  Press "Water pressure adjustment +" button.

-  Press "Rear washing" button.

- Choose and press the button of the item that you want to set.

Set whether or not to clean the wand automatically.

When set to "ON" Press "Water pressure adjustment +" button. + Short beep	When set to "OFF" Press "Water pressure adjustment -" button. - Long beep
---	---

Settings complete

Auto bowl CLEAN

Set whether or not to spray mist in the bowl unit automatically

-  Press "Stop" button until all LEDs on the remote control are lit or flashing. (about 10 seconds)

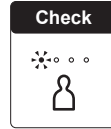

-  Press "Water pressure adjustment +" button.

-  Press "Front washing" button.

- Choose and press the button of the item that you want to set.

Set whether or not to spray mist in the bowl unit automatically.

When set to "spray" Press "Water pressure adjustment +" button. + Short beep	When set to "do not spray" Press "Water pressure adjustment -" button. - Long beep
--	--

Settings complete

Deodorizer

Set whether or not to deodorize automatically after sitting on the toilet seat

-  Press "Stop" button until all LEDs on the remote control are lit or flashing. (about 10 seconds)

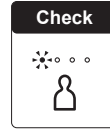

-  Press "Water pressure adjustment -" button.

-  Press "Front washing" button.

- Choose and press the button of the item that you want to set.

Set whether or not to deodorize automatically after sitting on the toilet seat.

When set to "ON" Press "Water pressure adjustment +" button. + Short beep	When set to "OFF" Press "Water pressure adjustment -" button. - Long beep
---	---

Settings complete

Auto power deodorizer

Set whether or not to power deodorize automatically after standing up

-  Press "Stop" button until all LEDs on the remote control are lit or flashing. (about 10 seconds)

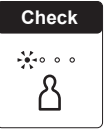



-  Press "Water pressure adjustment -" button.

-  Press "Water pressure adjustment +" button.

- Choose and press the button of the item that you want to set.

Set whether or not to power deodorize automatically after standing up

When set to "ON" Press "Rear washing" button.  Short beep	When set to "OFF" Press "Front washing" button.  Long beep
---	--

Settings complete

Changing Settings

Soft light

Set whether or not to use the soft light

1. ■ and +

Press and hold both the "Stop" button and "Water pressure adjustment +" button until the remote control LEDs are lit or flashing. (about 10 seconds)

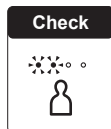

- 2.

Press "Rear washing" button.

- 3.

Press "Front washing" button.

4. Choose and press the button of the item that you want to set.

Set whether or not to use the soft light.

When set to "ON" Press "Water pressure adjustment +" button. + Short beep	When set to "OFF" Press "Water pressure adjustment -" button. - Long beep
--	--

Settings complete

Bowl light

Set whether or not to use the light inside the bowl unit

1. ■ and +

Press and hold both the "Stop" button and "Water pressure adjustment +" button until the remote control LEDs are lit or flashing. (about 10 seconds)

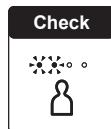

- 2.

Press "Rear washing" button.

3. +

Press "Water pressure adjustment +" button.

4. Choose and press the button of the item that you want to set.

Set whether or not to use the light inside the bowl unit.

When set to "ON" Press "Rear washing" button. Short beep	When set to "OFF" Press "Front washing" button. Long beep
--	---

Settings complete

CLEAN indicator

Set whether or not to light up the CLEAN indicator

1. ■ and +

Press and hold both the "Stop" button and "Water pressure adjustment +" button until the remote control LEDs are lit or flashing. (about 10 seconds)

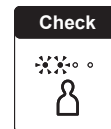

- 2.

Press "Rear washing" button.

3. -

Press "Water pressure adjustment -" button.

4. Choose and press the button of the item that you want to set.

Set whether or not to light up the CLEAN indicator

When set to "ON" Press "Rear washing" button. Short beep	When set to "OFF" Press "Front washing" button. Long beep
--	---

Settings complete

Beep sound

Set whether or not to make a beep sound

1. ■ and +

Press and hold both the "Stop" button and "Water pressure adjustment +" button until the remote control LEDs are lit or flashing. (about 10 seconds)

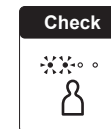

2. -

Press "Water pressure adjustment -" button.

- 3.

Press "Rear washing" button.

4. Choose and press the button of the item that you want to set.

Set whether or not to make a beep sound.

When set to "ON" Press "Water pressure adjustment +" button. + Short beep	When set to "OFF" Press "Water pressure adjustment -" button. - Long beep
--	--

Settings complete

Changing Settings

Pressure / position setting

Set whether or not to keep your favorite pressure and position settings

1. ■ and +

Press and hold both the "Stop" button and "Water pressure adjustment +" button until the remote control LEDs are lit or flashing. (about 10 seconds)

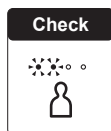

2. ☽

Press "Rear washing" button.

3. +

Press "Water pressure adjustment +" button.

4. -

Press "Water pressure adjustment -" button.
▶ The current setting is displayed.

5. -

Press "Water pressure adjustment -" button.
▶ The setting changes each time the button is pressed once.

Pressure/Position setting

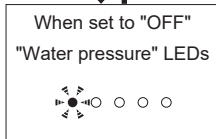
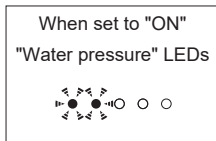

6. ■

Press "Stop" button.
Settings complete

Personal setting

Set whether or not to use the personal setting

1. ■ and +

Press and hold both the "Stop" button and "Water pressure adjustment +" button until the remote control LEDs are lit or flashing. (about 10 seconds)

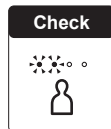

2. -

Press "Water pressure adjustment -" button.

3. +

Press "Water pressure adjustment +" button.

4. ☽

Press "Front washing" button.
▶ The current setting is displayed.

5. -

Press "Water pressure adjustment -" button.
▶ The setting changes each time the button is pressed once.

Personal setting

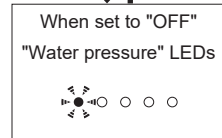
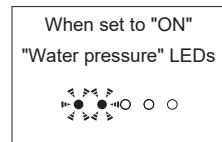

6. ■

Press "Stop" button.
Settings complete

Registering Personal Settings*1

Register your preferred wand position, etc.

1. ☽

Press "Personal setting" button.

Select the location to be set

▶ The setting changes each time the button is pressed once.

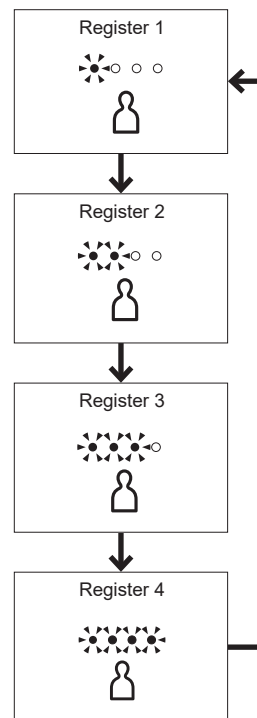

2. Set your preferences for "Wand position", "Water pressure" and "Warm water temperature" during "Rear washing", etc.

3. ☽

Press "Personal setting" button about 5 seconds or longer. (Short beep)

Settings complete

*1 Cannot be performed when "Personal setting" is set to "OFF".

Maintenance

Before maintenance

⚠ WARNING

Always turn off the power before maintenance or inspection.

Failure to do so may cause electric shock or malfunction, resulting in a breakdown.

For safety, turn the power OFF before maintenance.*1*2

When the power is turned OFF, the Power LED is unilluminated.

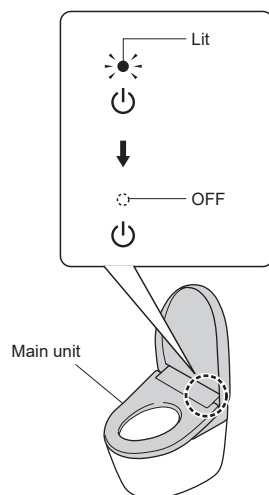

To turn the power "OFF"

Remove the cover on the left side of the main unit, and flip the power switch to "OFF".

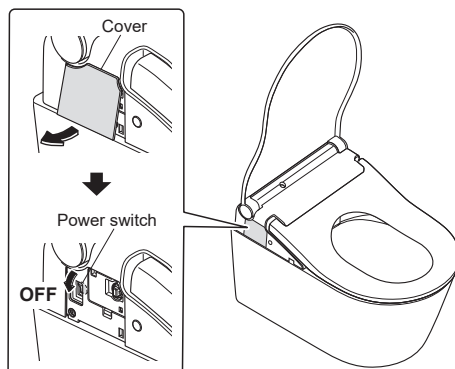

To turn the power "ON"

Flip the power switch to ON.

▶ The "Power" LED illuminates.

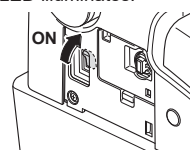

Reinstall the cover.

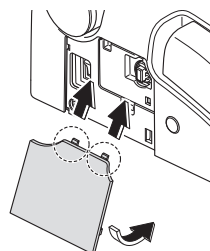

Main unit

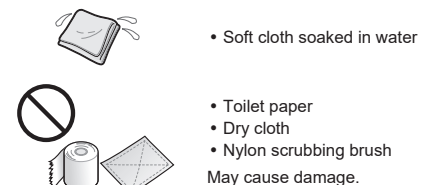

Approximately daily

1. Turn the power "OFF". (→Page 40)

2. Wipe with a soft cloth that has been soaked in water and wrung out thoroughly.

For heavy dirt

Wipe with a soft cloth soaked in diluted, pH neutral kitchen detergent, and then wipe with a soft cloth soaked in water.

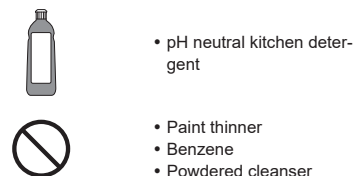

3. Turn the power "ON". (→Page 40)

▶ The "Power" LED illuminates.

Attention

This product is an electric appliance. Be careful not to let water seep inside or leave detergent in the gap between the main unit and bowl unit.

Do not put any cleaning solution directly onto the warm air outlet or cover around the wand, etc. May damage plastic parts or cause a malfunction.

When using a toilet cleaner to clean the toilet, rinse it off within 3 minutes and leave the toilet seat and toilet lid open.

Wipe off any cleaner that remains on the bowl unit.

If vapor from a toilet cleaner enters the main unit, it may cause a malfunction.

<If "Auto flush lid closed" (→Pages 30, 31) is turned ON> (→Page 8)

Do not press or pull the warm air outlet or cover around the wand with excessive force. May cause damage or malfunction.

Wipe the back surface of the toilet seat and the toilet seat cushions with a soft cloth tightly wrung out with water.

Otherwise adhesion of dirt may result in discoloration.

Be sure to wipe off any water droplets on the toilet seat. Failure to do so may cause malfunction of the seat sensor.

*1 Except when using "Wand cleaning", "Descaling mode", "Spray nozzle" or "Manual spray".

*2 The toilet lid does not open automatically for about 10–60 seconds after the power is turned ON (preparing).

Operate with the remote control.

Maintenance

Manual Spray

EWATER+ mist can be sprayed to separate dirt from the surface for maintenance.

Approximately daily

Remote control back side

How to remove the remote control (→Page 12)



Press "Manual spray" button.

► EWATER+ mist is sprayed on the bowl unit.

Note: It cannot be used when the wand is out or when you are sitting on the toilet seat.

Wand



• Soft cloth soaked in water

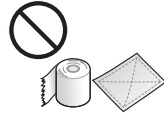

• Toilet paper
• Dry cloth
• Nylon scrubbing brush
May cause damage.

Approximately once a month If you notice dirt (Wand cleaning)

1. Extend the wand.

To operate from the back of remote control

Remote control back side

How to remove the remote control (→Page 12)



Press "Wand cleaning" button.

To operate from the front of remote control

Recommended if the remote control is secured to prevent theft, etc.

1)  and 

Press and hold both the "Stop" button and "Water pressure adjustment +" button until the remote control LEDs are lit or flashing. (about 10 seconds)

Check



2) 

Press "Water pressure adjustment +" button.

3) 

Press "Front washing" button.

4) 

Press "Rear washing" button.

2. Wipe with a soft cloth that has been soaked in water and wrung out thoroughly.

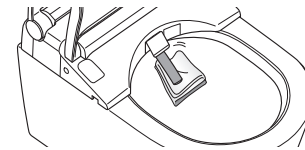

Attention

Do not pull, push or press the wand with excessive force.
May cause damage or malfunction.

3. ■

Press "Stop" button on the front side of the remote control.

► The wand retracts.

► Water comes out from around the wand.

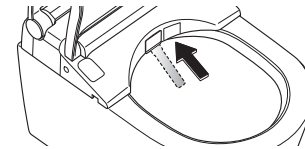

Deodorizing Filter

Approximately once a month

1. Turn the power "OFF". (→Page 40)

2. Remove the deodorizing filter.
Hold the tab and pull outward.

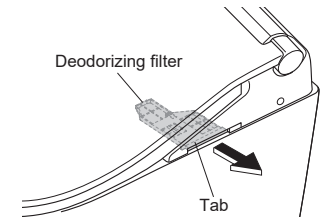

Attention

Do not pull the unit with undue force.
Doing so may cause damage or malfunction.

3. Clean with a tool such as a toothbrush.

► When washing with water, dry off all water before reinserting.

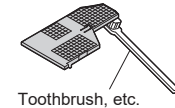

Toothbrush, etc.

4. Mount the deodorizing filter.

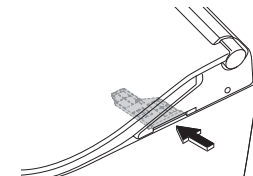

Push firmly until a click sound is heard.

5. Turn the power "ON". (→Page 40)

► The "Power" LED illuminates.

Maintenance

Gap between the Main Unit and Bowl Unit

You can remove the main unit to clean the top of the bowl unit and the bottom of the main unit.

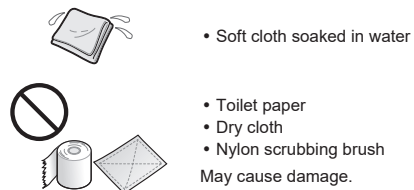

Approximately once a month

1. Turn the power "OFF". (→Page 40)

⚠ CAUTION

If the power is not turned off, the unit may malfunction, causing a failure or electric shock.

2. Remove the main unit (a string is attached to the bottom of the main unit).

- 1) Pull the main unit toward you while pressing the "Main unit removal button".

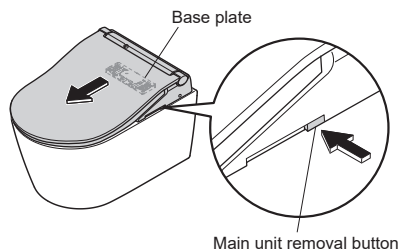

Attention

Do not pull the unit with undue force.
The main unit is connected to the base plate using a string.

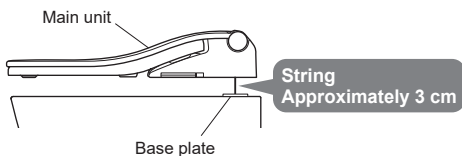

3. Clean the top of the bowl unit and the bottom of the main unit.

- 1) Wipe with a soft cloth soaked in a diluted, neutral kitchen detergent. Then, wipe it with a soft cloth soaked in water so that no detergent remains.

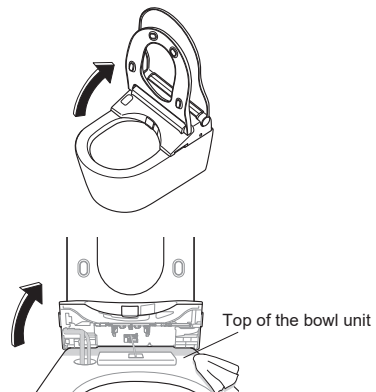

4. Mount the main unit.

- 1) Lift the main unit, then lower it straight down while threading the power cord and water supply hose into the recess on the bowl unit.

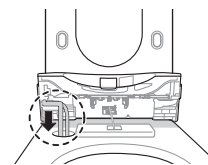

Attention

Be careful not to pinch the power cord.

Do not excessively bend the water supply hose.

- 2) Align the main unit with the center of the base plate and press it firmly onto the base plate until a click sound is heard.

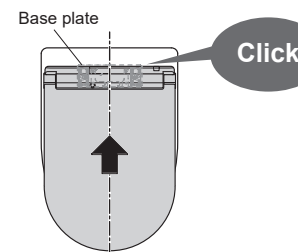

⚠ CAUTION

Push the main unit firmly on to the base plate until a click sound is heard.

Failure to do so could cause the main unit to come loose resulting in injury.

- 3) After mounting, check that the main unit does not detach even when pulled.

5. Flip the power switch to ON. (→Page 40)

► The "Power" LED lights up.

Maintenance

Gap between the Main Unit and the Toilet Lid

The toilet lid can be removed for thorough cleaning.



- Soft cloth soaked in water

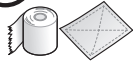

- Toilet paper
 - Dry cloth
 - Nylon scrubbing brush
- May cause damage.

Approximately once a month

1. Turn the power "OFF". (→Page 40)

2. Remove the toilet lid.

Strongly pull it out, starting with A and finishing with B.

Hold with both hands

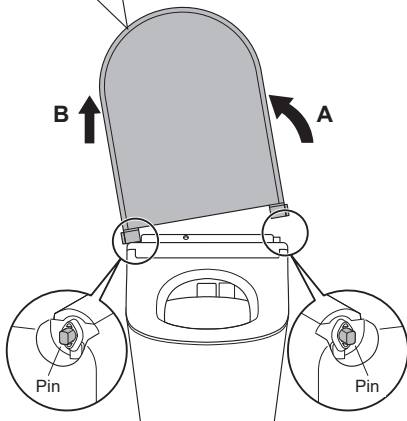
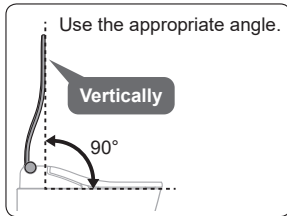

3. Wipe with a soft cloth that has been soaked in water and wrung out thoroughly.

4. Reinstall the toilet lid.

Insert C and then D into the pins.

Attention

Do not use excessive force.

Hold with both hands

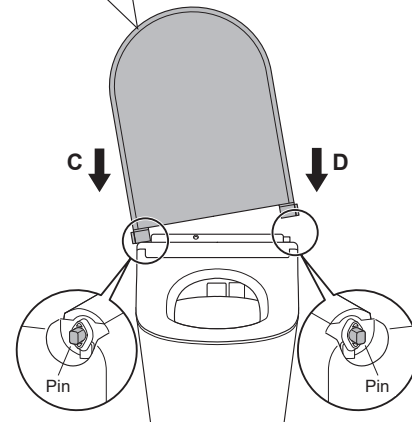
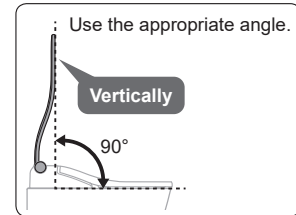

5. Flip the power switch to ON. (→Page 40)

▶ The "Power" LED lights up.

6. Open and close the toilet lid to check the reinstallation.

Maintenance

Descaling Agent

Usable descaling agents

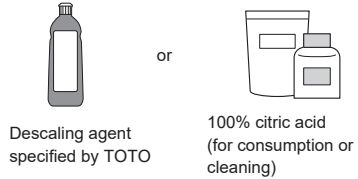

Request regarding the descaling agent

Please use the descaling agent properly according to the precautions from the manufacturer. Use the descaling agent with the correct dilution. Do not directly insert undiluted descaling agent or powder into the toilet, and make sure the agent is completely dissolved. Do not use a descaling agent other than the specified descaling agents. Doing so may cause damage.

Descaling agent specified by TOTO

If you wish to use other agents, please contact us on the phone number on the back of this manual.

Product name	Manufacturer
Sidol® Universal-Entkalker (liquid)	Henkel AG & Co. KGaA
Bref POWER® Universal-Entkalker (liquid)	
Oust® ALL PURPOSE DESCALER (liquid)	

How to dilute

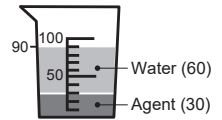

Pour and mix thoroughly

If the beaker is missing

Please use a clean cup and dilute 30 ml of agent with 60 ml of water.

Product name	Manufacturer
swirl® Anti Calc Bio Power Concentrate	Melitta Group
swirl® Anti Calc Bio flüssig	

How to dilute

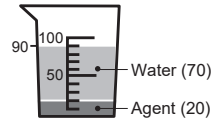

Pour and mix thoroughly

If the beaker is missing

Please use a clean cup and dilute 20 ml of agent with 70 ml of water.

[SIDOL], [Bref POWER] and [OUST] are registered trademarks of [Henkel AG & Co. KGaA].
[swirl] is a trademark of company of the [Melitta Group].

100% citric acid (for consumption or cleaning)

Do not use descaling agents that contain organic acids other than citric acid, surfactants, silicone, or preservatives.

How to dilute

1) Place 60 ml of cold or warm water into the provided beaker.

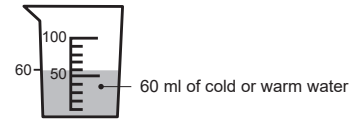

2) Insert the citric acid, and stir well.

If the product indicates how much to use

Follow the instructions on the product.

If the product does not indicate how much to use

Use about one tablespoon (10 to 20 g).

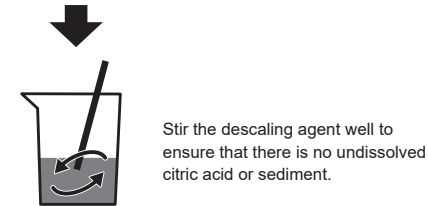

If the beaker is missing

Place 60 ml of cold or warm water into a clean cup or similar object, and insert the citric acid (the amount indicated above) to dilute it.

Descaling

If you think the water pressure has weakened "OR" When "Power" LED (orange) and "Energy saver" LED (orange) flash

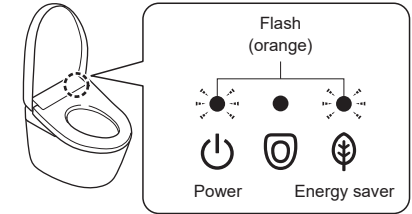

Items to prepare

included item

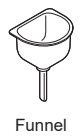

Descaling agent



or

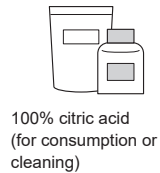

Maintenance

Descaling mode

Note: Washing modes (such as rear and front) cannot be used from step 2 until the second descaling operation in step 9 is complete.

The following functions can be operated with the remote control after the descaling operation in step 9 starts.

- Auto flushing (Full flush, Light flush)

The following functions can be operated with the remote control from approximately 10 minutes after the descaling operation in step 9 starts.

- Opening and closing the toilet lid, Opening and closing the toilet seat

If the work is delayed for more than 30 minutes between steps 2 and 9, the descaling agent will be drained to the toilet with a long beep sound to alert.

If you want to stop the work between steps 2 and 9, flip the power switch to "OFF", and then flip it to "ON". (→Page 40)

Descaling agent will be drained to the toilet with a repeating beep sound to alert. Washing modes (rear, rear soft and front) cannot be used while the long beep sound is alerting.



Attention

To perform descaling:







Completely open the Shutoff valve, without opening and closing it partway. Do not use water in other locations such as the bathroom or kitchen.

Changes to the amount of water supplied may cause the descaling operation to not complete normally.

1. Set descaling mode.

-  and 
 Press and hold both the "Stop" button and "Water pressure adjustment +" button until the remote control LEDs are lit or flashing. (about 10 seconds)

Check

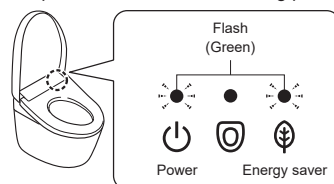

- 
 Press "Water pressure adjustment +" button.
- 
 Press "Rear washing" button.
- 
 Press "Front washing" button.

- ▶ Water passage is drained. (for about 30 seconds)
 - You will hear short beep sound.
 - Water comes out from around the wand.
 - "Power" LED (green) and "Energy saver" LED (green) will flash. (The LEDs will continue to flash until the completion of the entire descaling process.)



- ▶ When water draining is completed, you will hear a long beep sound.

Descaling mode (1st time) Steps 2 to 5

- Dilute agent with water. (→Please see *How to dilute* on pages 48, 49.)
- Open the lid and remove cover and cap on the top face of product.

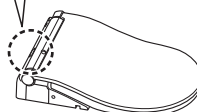
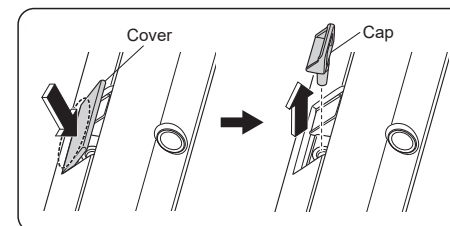
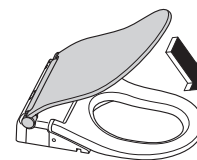

Attention

Please retain cover and cap.

4. Insert funnel and pour diluted agent.

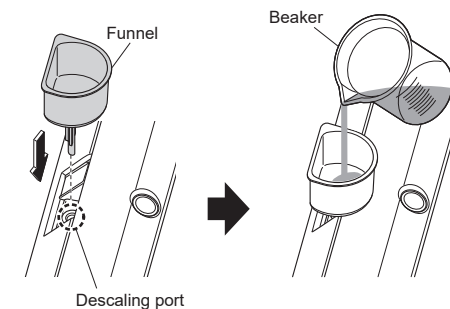

Attention

Please wait until funnel is empty.

Descaling will not work correctly.

If any cleaning agent is spilled on the product, please wipe it off with a soft cloth that has been soaked in water and wrung out thoroughly.

Failure to do so may cause discoloration.

Maintenance

Descaling mode (Continued)

5. Perform descaling.

- 1) ■ and +

Press and hold both the "Stop" button and "Water pressure adjustment +" button until the remote control LEDs are lit or flashing. (about 10 seconds)

Check



- 2) +

Press "Water pressure adjustment +" button.



- 3) Press "Rear washing" button.

- 4) +

Press "Water pressure adjustment +" button.

► Descaling will be performed.
(for about 30 seconds)

- You will hear short beep sound.
- Water comes out from around the wand and the mist nozzle.

► When water draining is completed, you will hear a long beep sound.

Descaling mode (2nd time) Steps 6 to 9

6. Dilute agent with water.

(→Please see **How to dilute** on pages 48, 49.)

7. Pour diluted agent. (→Page 51 step 4)

8. Remove the funnel and put cap and cover back on.

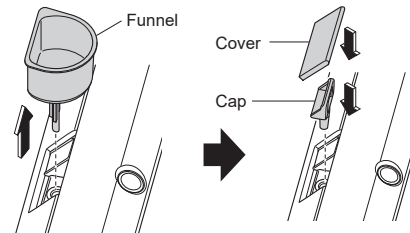

Attention

If any cleaning agent is spilled on the product, please wipe it off with a soft cloth that has been soaked in water and wrung out thoroughly.
Failure to do so may cause discoloration.

9. Perform descaling.

- 1) ■ and +

Press and hold both the "Stop" button and "Water pressure adjustment +" button until the remote control LEDs are lit or flashing. (about 10 seconds)

Check



- 2) +

Press "Water pressure adjustment +" button.



- 3) Press "Rear washing" button.

- 4) +

Press "Water pressure adjustment +" button.

► Descaling will be performed.
(for about 60 minutes)

- Water comes out from around the wand and the mist nozzle at about 20 minute intervals.
- After about 60 minutes, descaling agent will be drained to the toilet.
- After draining, you will hear a long beep sound, and the LEDs on product main body stop flashing.

Descaling complete

Attention

1. If the spray is still weak after performing Descaling mode:

- Clean the Drain plug with water supply filter.
(→Page 54)

2. If the spray is still weak after performing 1:

- Clean the spray nozzle. (→Page 55)

3. If the problem does not resolve after performing 1 and 2, or if the "Power" LED (orange) and "Energy saver" LED (orange) start to flash after a while:

- Perform Descaling mode again. (→Page 50)

Maintenance

Drain Plug with Water Supply Filter

Approximately once every 6 months
If the water pressure is still weak even after performing descaling

1. Close the shutoff valve. (→Page 62)
 - ▶ The water supply stops.

CAUTION

Do not remove the drain plug with water supply filter while the shutoff valve is open. Otherwise, water may leak out.

2.  Press "Wand CLEAN" button. (Release the pressure from the water supply pipe.)
 - ▶ Water comes out from around the wand.

3. Turn the power "OFF". (→Page 40)

4. Remove the water filter drain valve.
 - ▶ Loosen the water filter drain valve with a flat-head screwdriver and then pull it.

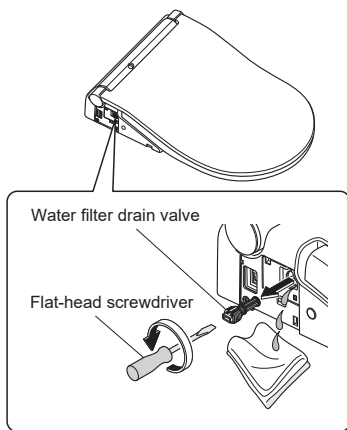

5. Clean the filter with a tool such as a toothbrush.
 - ▶ Also, remove any dust from inside the hole of the drain plug with water supply filter.

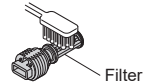

If there is scale on the filter

- ▶ Descal the filter using the descaling agent specified by TOTO or 100% citric acid (for consumption or cleaning), then wash it with water. (→Pages 48, 49 "Descaling Agent")

Attention

Do not use a descaling agent other than the specified descaling agents. Doing so may cause damage.

6. Reinstall the water filter drain valve.
 - ▶ Insert the water filter drain valve and use a flat-head screwdriver to tighten it securely.

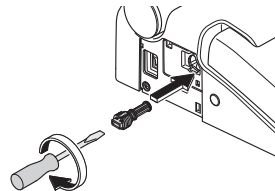

7. Turn the power "ON". (→Page 40)
 - ▶ The "Power" LED illuminates.

8. Open the shutoff valve. (→Page 13)

Spray Nozzle

If the water pressure is still weak even after performing descaling and drain plug with water supply filter cleaning

1. Remove the spray nozzle from the wand.
 - 1) Extend the wand. (→see step 1 on page 42)
 - 2) While holding the wand with a hand, press on both sides of the spray nozzle and slide it.

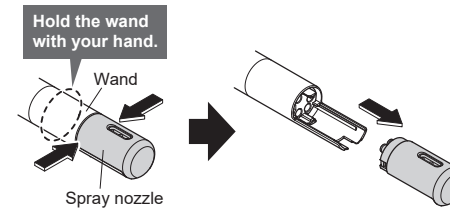

Attention

Do not pull with undue force. May cause damage or malfunction.

2. Install a spray nozzle (for replacement).

Check that the gasket is attached.



Note: The color and shape of the gasket differ for some products.

- 1) Hold the wand by hand and slide the replacement spray nozzle along the guide and push it in.
 - ▶ Install correctly until a click sound is heard.

Hold the wand with your hand.

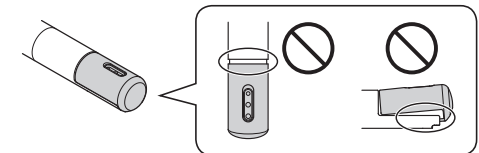
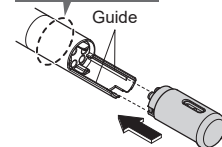

Attention

Do not push with undue force. May cause damage or malfunction.

- 2)  Press "Stop" button on the front side of the remote control.
 - ▶ The wand retracts.
 - ▶ Water comes out from around the wand.

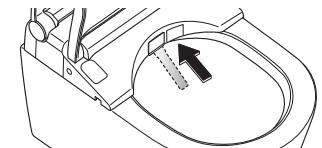

Attention

Keep the spare nozzle in safe place.

Maintenance

Cleaning the blocked Nozzle

Descal the removed spray nozzle using the descaling agent specified by TOTO or 100% citric acid (for consumption or cleaning), then wash it with water.

(→Pages 48, 49 "Descaling Agent")

Attention

Do not disassemble the spray nozzle.
May cause malfunctions.

Do not use a descaling agent other than the specified descaling agents.

Doing so may cause damage.

What to Do?

If the water does not flow due to a water service interruption

Make sure to also check the instruction manual of your bowl unit.

1. Use a bucket to flush the bowl unit.

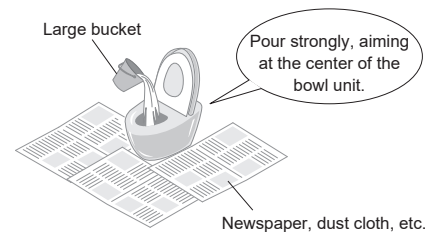

2. If the water level is low after flushing, add more water.
(Until the water level does not rise further.)

▶ Prevents odors.

Attention

If there is a water supply failure, set the auto bowl unit cleaning to "OFF".* (→Page 29)

When the water supply is restored, make sure to first use water in the bath or kitchen (not with this product) to remove air from the water supply pipes.

Otherwise, air or foreign objects may enter this product, causing failure.

When the water supply is restored, be sure to perform a flush.

To prevent waste from remaining in the drain pipe.

If you cannot operate with the remote control

If the low battery warning mark "  " on the surface of the remote control is flashing, please replace the batteries.

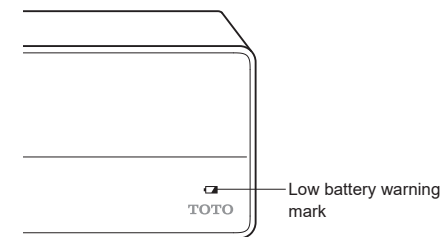

Replacing the batteries

1. Turn the power "OFF". (→Page 14)
2. Remove the remote control from the hanger. (→Page 12)
3. Open the battery cover and replace the two AAA batteries. (→Page 12)
▶ The low battery warning mark goes off.
4. Mount the remote control in the hanger. (→Page 12)
5. Turn the power "ON". (→Page 13)
▶ The "Power" LED illuminates.

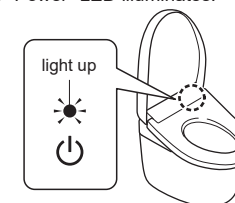

Attention

"ON" and "OFF" settings of the functions such as the energy saver function may be canceled when the batteries are replaced.
Set them again.

*1 Except TCF801EG, TCF801EAG, TCF803EG

What to Do?

Freeze Damage Prevention

When the ambient temperature is likely to drop to 0 °C or lower, take measures to prevent freezing.

Attention

When the ambient temperature is likely to drop to 0 °C or lower, do not use the energy saver feature. May damage the product.

Warm the bathroom or take measures against freezing so that the ambient temperature does not drop below 0 °C.

Before starting to work, set "Auto flushing"^{*1} (→Page 29) and "Auto open/close" (→Page 32) to "OFF".

1. Close the shutoff valve. (→Page 62)

▶ The water supply stops.

CAUTION

Do not remove the drain plug with water supply filter while the shutoff valve is open. Otherwise, water may leak out.

2. 

Press "Wand CLEAN" button. (Release the pressure from the water supply pipe.)

▶ Water comes out from around the wand.

3. Turn the power "OFF". (→Page 14)

4. Remove the water filter drain valve.

▶ Loosen the water filter drain valve with a flat-head screwdriver and then pull it.

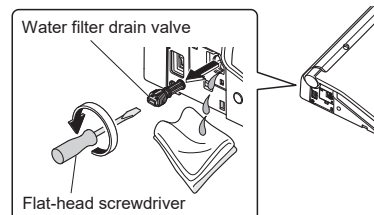

If there is scale on the filter

▶ Descal the filter using the descaling agent specified by TOTO or 100% citric acid (for consumption or cleaning), then wash it with water. (→Pages 48, 49 "Descaling Agent")

Attention

Do not use a descaling agent other than the specified descaling agents.

Doing so may cause damage.

5. When water draining is completed, reinstall the water filter drain valve.

▶ Insert the water filter drain valve and use a flat-head screwdriver to tighten it securely.

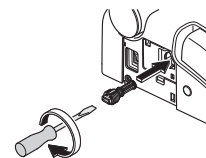

6. Turn the power "ON". (→Page 13)

▶ The "Power" LED illuminates.

7. Set the toilet seat temperature to "High". (→Page 22)

▶ To maintain the temperature, close the toilet seat and toilet lid after finishing work.

To use the product again

▶ The water needs to be resupplied. (→Page 61)

Long Periods of Disuse

If the toilet is in a location you will not visit for a long time, drain the water.

The water in the tank may cause malfunctions or become contaminated and cause skin irritation or other problems.

How to drain the water

1. Close the shutoff valve. (→Page 62)

▶ The water supply stops.

CAUTION

Do not remove the drain plug with water supply filter while the shutoff valve is open. Otherwise, water may leak out.

2. 

Press "Wand CLEAN" button. (Release the pressure from the water supply pipe.)

▶ Water comes out from around the wand.

3. Turn the power "OFF". (→Page 14)

4. Remove the water filter drain valve.

▶ Loosen the water filter drain valve with a flat-head screwdriver and then pull it.

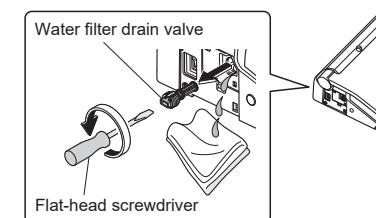

*1 Except TCF801EG, TCF801EAG, TCF803EG

What to Do?

Long Periods of Disuse (Continued)

If there is scale on the filter

- ▶ Descal the filter using the descaling agent specified by TOTO or 100% citric acid (for consumption or cleaning), then wash it with water. (→Pages 48, 49 "Descaling Agent")

Attention

Do not use a descaling agent other than the specified descaling agents.
Doing so may cause damage.

- When water draining is completed, reinstall the water filter drain valve.

- ▶ Insert the water filter drain valve and use a flat-head screwdriver to tighten it securely.

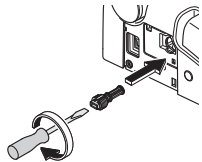

- Reinstall the cover. (→Page 40)

- Pull out the water drain lever.

- ▶ Water comes out from around the wand. (about 20 seconds)

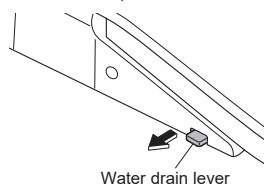

- Release your hand to return the water drain lever to its original position.

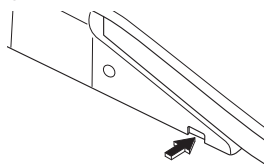

If water may get frozen

- ▶ Add antifreeze solution to the water in the bowl to prevent freezing. The antifreeze solution should not be flushed out. Collect it before using the toilet and dispose of it.

To use the product again

- ▶ The water needs to be resupplied. (→See right)

Resupplying the Water

- Open the shutoff valve. (→Page 13)
 - ▶ Check that water is not leaking from a pipe or the main unit.
- If the power is not on, turn the power ON. (→Page 13)
- Reinstall the cover. (→Page 40)
- Discharge water from the wand.
 - Keep your hand or arm in contact with the seat sensor. (Refer to page 9)
 - 
 Press "Rear washing" button to discharge water from the wand.
 - ▶ Catch the water in a paper cup or other receptacle.
 - Move your hand or arm from the seat sensor.

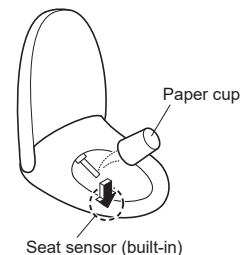

If the remaining water has frozen and no water comes out

- ▶ Heat the inside of the bathroom, and warm the water supply hose and shutoff valve using a cloth soaked in warm water.

How to remove the operation guide

To remove, follow the procedure below.

- Turn the power "OFF". (→Page 14)
- Remove the remote control from the hanger. (→Page 12)
- Remove the hanger and operation guide.

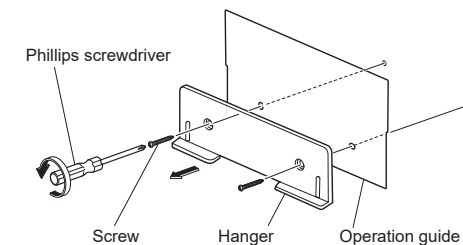

- Screw the hanger on the wall.

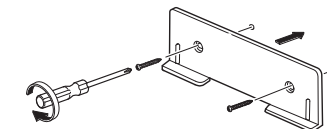

- Mount the remote control in the hanger.

- Turn the power "ON". (→Page 13)

- ▶ The "Power" LED illuminates.

To install back the operation guide, follow the procedure above.

- ▶ Install the operation guide at step 4.

Troubleshooting

First, try the actions described on pages 62–70. If the problem persists, consult the installer, seller, or TOTO Service (→see contact information on the back cover).

CAUTION

If a water leak occurs, close the shutoff valve.

Wall-mounted bowl unit

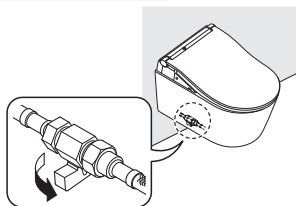

Floor-mounted bowl unit

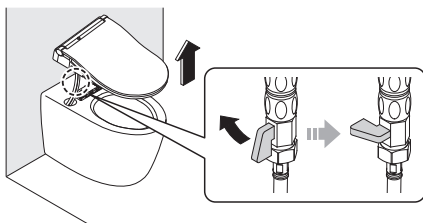

First remove the main unit before proceeding. (→Page 44)

Please check first (A–C)

A: Is the Power LED illuminated?
Is the main unit working?

Is the breaker on the distribution board turned on?

- ▶ Check whether there is a power outage or the breaker has turned "OFF".

Is the power switch flipped to "OFF"?

- ▶ Flip it to "ON". (→Page 13 step 2-2.2)

Is the "Power ON/OFF" setting "OFF"?

- ▶ Switch it to "ON" with the remote control. (→Page 13 step 2-2.2)

B: Is the Energy saver LED lit?

- ▶ While the LED is lit, energy saver (→Page 26) is in operation, so the toilet seat temperature may be reduced or the heater may be turned off.

C: Is the remote control working?

Is the low battery warning mark  on the surface of the remote control flashing?

- ▶ Replace the batteries. (→Pages 12, 57)

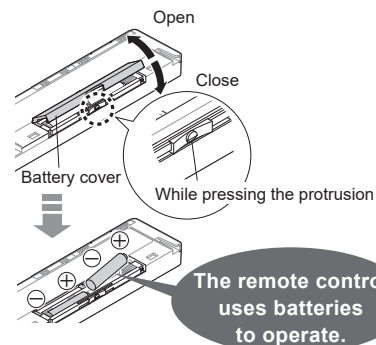

Is the remote control transmitter or the remote control receiver blocked?

- ▶ Remove obstructions, dirt, water droplets or any other blockages.

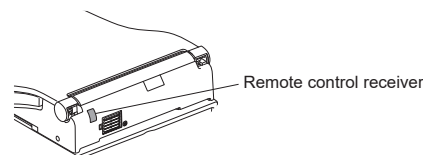
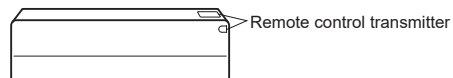

Rear Washing, Front Washing and Wand

Trouble	Please check
The wand (or washing water) does not come out	<p>When the temperature is low, it takes time for the wand to come out after the remote control button is pressed because the water must be warmed up first.</p> <p>Has the toilet been sat "ON" and used continuously for 2 hours or longer? (If so, operation is stopped for safety purposes.)</p> <ul style="list-style-type: none"> ▶ Stand up from the seat and then use again. <p>When sitting on the toilet seat, is there a toilet seat cover or clothing on the seat sensor? Are you sitting without touching any part of the seat sensor?</p> <ul style="list-style-type: none"> ▶ Check the position of the seat sensor, then sit so your skin is in direct contact with the seat sensor. (→Page 9) <p>Are you using a toilet seat cover, a toilet lid cover or a seat for infants?</p> <ul style="list-style-type: none"> ▶ Remove any covers. When using a seat for infants or a soft highchair, remove after each use. (→Page 8) <p> Covers</p> <ul style="list-style-type: none"> ▶ Are you pressing "Wand CLEAN" button? ▶ When you press "Wand CLEAN" button, "EWATER+" comes out from the vicinity of the wand. ▶ To clean the wand with it extended, perform "Wand cleaning". (→Page 42) <p>Is descaling being performed?</p> <ul style="list-style-type: none"> ▶ Washing modes (such as rear and front) cannot be used during descaling. (→Pages 50–53) <p>The wand (or cleansing water) may not come out due to the accumulation of scale.</p> <ul style="list-style-type: none"> ▶ Perform descaling. (→Pages 50–53) <p>If the water supply pressure drops significantly, for example if water is used elsewhere or if there is a water failure, the function may stop for safety.</p> <ul style="list-style-type: none"> ▶ Turn the power OFF and wait about 10 seconds before turning the power ON again. (→Pages 13, 14) <p>If the above symptom reappears There may be a malfunction.</p> <ul style="list-style-type: none"> ▶ Consult with TOTO Service. (→see contact information on the back cover)
The wand extends but the washing water does not come out / The washing water pressure is weak	<p>Has a water failure occurred?</p> <ul style="list-style-type: none"> ▶ Press "Stop" button on the remote control and wait until water service is restored. <p>Is the shutoff valve closed?</p> <ul style="list-style-type: none"> ▶ Fully open the shutoff valve. (→Page 13) <p>Perform Descaling mode. (→Pages 50–53)</p> <p>Is the water pressure set to a low level? (→Page 18)</p>
The washing water is cold	<p>Is the warm water temperature set to "OFF" or a low level? (→Page 22)</p> <p>When the temperature of the water supply or the bathroom is low, the water temperature may be low when first sprayed.</p>
Wash functions stop unintentionally during use	<p>"Rear washing", "Rear soft washing" and "Front washing" stop automatically after 5 minutes of continuous use.</p> <p>Then the "Power" LED (Green) and the "Energy saver" LED (Green) on the display of the main unit flash about 60 seconds while hot water is prepared.</p> <ul style="list-style-type: none"> ▶ Wait until the LEDs on the display of the main unit light up solidly and then press the button again.

Troubleshooting

Rear Washing, Front Washing and Wand (Continued)

Trouble	Please check
Wash functions stop unintentionally during use	Does the seat sensor have difficulty detecting? ▶ If you get up slightly from or sit towards the left of the seat, the seat sensor may temporarily stop detecting your presence. (→Page 9)
Water comes out unexpectedly from the wand	When you sit on the toilet seat, water comes out for several seconds while water is warmed up. Has the CLEAN indicator light up in a cycle? ▶ "Auto wand CLEAN" starts and the wand is cleaned. (→Page 17)

Warm air drying

Trouble	Please check
The dryer temperature is low	Is the dryer temperature set to low level? (→Page 22)
Stops in the middle of use	The feature stops automatically after about 10 minutes of continuous use. Does the seat sensor have difficulty detecting? ▶ If you get up slightly from or sit towards the left of the seat, the seat sensor may temporarily stop detecting your presence. (→Page 9)

Flushing*1

Trouble	Please check
For not flushing	Are the main tap and the in-wall tank's shutoff valve fully open? (→Page 13) Has a water failure occurred? ▶ Use a bucket to flush water. (→Page 57)
The toilet does not flush even when the button of remote control is pressed	Are you pressing the button repeatedly? ▶ After pressing the flush button, operation will not be accepted for about 10 to 20 seconds. Is descaling being performed? ▶ Flushing may not be performed during descaling, even if the button is pressed. (→Pages 50–53)
The bowl unit does not clean automatically or the timing is delayed (Auto flushing)	Is "Auto flushing" set to "OFF"? ▶ Set to "ON". (→Page 29) Even if "Auto flushing" is set to "ON", it is not available in the following instances. About 60 seconds after the toilet is flushed. ▶ Wait about 60 seconds and flush the toilet with the remote control. (→Page 19) When the time spent sitting on the toilet seat or standing in front of the bowl unit is less than about 6 seconds. ▶ Use the remote control to flush the bowl unit. (→Page 19) When staying in front of the bowl unit after standing and using the toilet. ▶ Step away from the toilet and wait for about 3 seconds. When water droplets or dirt are disrupting the body sensor. ▶ Remove any dirt that is on the body sensor. (→Page 10)

*1 Except TCF801EG, TCF801EAG, TCF803EG

The bowl unit does not clean automatically or the timing is delayed (Auto flushing)

During descaling ▶ "Auto flushing" is not performed during descaling. (→Pages 50–53)
When sitting on the toilet seat, is there a toilet seat cover or clothing on the seat sensor? Are you sitting without touching any part of the seat sensor? ▶ Check the position of the seat sensor, then sit so your skin is in direct contact with the seat sensor. (→Page 9)
The timing for the "Auto flushing" can be changed. (→Page 30)

The toilet flushes on its own

Is "Auto flushing" set to "ON"? ▶ You can turn it "OFF". (→Page 29)
Does the seat sensor have difficulty detecting? ▶ If you get up slightly from or sit towards the left of the seat, the seat sensor may not detect, and thus auto flushing may occur during use. (→Page 9)

Toilet Seat and Toilet Lid (Auto open/close)

Trouble	Please check
The toilet lid does not open automatically	Is "Auto open/close" set to "OFF"? ▶ Set to "ON". (→Page 32) Even when set to "ON", "Auto open/close" is not performed. • Approximately 15 seconds since the toilet seat or toilet lid closed automatically • During descaling. (→Pages 50–53) When the toilet lid is closed with the remote control or by hand To make the product more user-friendly, a time interval is set from when the lid is closed to when it will open next. ▶ Move away from the toilet and wait at least about 15 seconds before approaching the bowl unit again or open and close by hand. (→Page 19)
	Does the body sensor have difficulty detecting? ▶ Remove any dirt that is on the body sensor. Detection by the body sensor may be difficult when the room temperature exceeds 30 °C. ▶ Use the remote control to open or close it. (→Page 19)
	Is "Auto open delay" set to "Middle" or "Long"? (→Page 33)
	The toilet lid does not open automatically for about 10–60 seconds after the power is turned ON. ▶ Use the remote control to open or close it. (→Page 19)
	Is a toilet lid or seat cover installed? ▶ Remove any covers. (→Page 8)
The toilet lid does not close automatically	Is "Auto open/close" set to "OFF"? ▶ Set to "ON". (→Page 32) In the following cases, the toilet lid closes in about 5 minutes. • When you did not sit on the toilet seat • When you sat on the toilet seat for less than 6 seconds • When you stood in front of the bowl unit for less than 6 seconds. If they do not close automatically even though "Auto open/close" is set to "ON", the body sensor may be detecting incorrectly. ▶ If there is a reflective object in front, such as a mirror or glass, move the reflective object or use a curtain or other object to block it.
	Is descaling being performed? ▶ "Auto open/close" is not performed during descaling. (→Pages 50–53)

Troubleshooting

Toilet Seat and Toilet Lid (Auto open/close) (Continued)

Trouble	Please check
The toilet lid opens on its own	<p>Is the body sensor directly exposed to sunlight? ► Do not directly expose the body sensor to sunlight, because it may cause incorrect detection. (→Page 9)</p> <p>Is there a heater within the detection range of the body sensor? ► Do not place within the detection range of the body sensor. (→Page 9)</p> <p>Is a urinal or wash basin also installed in the bathroom? ► The body sensor may detect someone using the urinal, causing the toilet lid to open or close.</p> <p>When the bathroom door is open, the sensor may detect people who pass in front of the toilet.</p>
The toilet lid closes on its own	<p>Is "Auto open/close" set to "ON"? ► You can turn it "OFF". (→Page 32)</p> <p>Is "Auto close delay" set to "Short"? (→Page 32)</p> <p>When sitting on the toilet seat, is there a toilet seat cover or clothing on the seat sensor? Are you sitting without touching any part of the seat sensor? ► Check the position of the seat sensor, then sit so your skin is in direct contact with the seat sensor. (→Page 9)</p>
The toilet lid and toilet seat open at the same time	Is "Seat/lid" set to "Seat-lid"? (→Page 33)
Stops (or closes) while opening	<p>If the toilet lid or seat hits an obstruction the first time it opens after the power is turned ON, it may stop (or close) partway during the next operation. ► Eliminate any obstructions and turn the power OFF. Turn the power ON again after about 5 seconds. Then press the "Opening and closing the toilet lid" button on the remote control. (→Pages 13, 14, 19)</p>
The open timing has changed	Detection by the body sensor may be difficult when the room temperature exceeds about 30 °C, such as in the summertime. (→Page 9)
Cannot open or close with the remote control	<p>If it opens automatically. ► Check "Is the remote control working?" (→Page 62)</p> <p>If automatic opening does not work either The toilet lid may not be mounted correctly. ► Mount them correctly. (→Page 46)</p> <p>Is descaling being performed? ► The toilet lid does not open and close during descaling, even if the button is pressed. (→Pages 50–53)</p> <p>Incorrect detection may occur when operating under fluorescent lights.</p>

Toilet Seat and Toilet Lid

Trouble	Please check
The toilet seat is cold	<p>Is the toilet seat temperature set to "OFF" or a low level? (→Page 23)</p> <p>Is energy saver in operation? The energy saver feature is on when the "Energy saver" LED is on and the "Power" LED is off on the main display. When you sit on the seat, the toilet seat heater is turned on temporarily and the seat is warmed in about 15 minutes. (→Page 26) ► You can turn it "OFF" if the energy saver feature is "ON". (→Pages 28, 29)</p> <p>Have you been seated for a long time? After about 20 minutes of sitting, the temperature starts reducing, and after about 1 hour, the toilet seat heater is turned "OFF". ► Stand up from the seat and then use again.</p> <p>Is a toilet lid or seat cover installed? ► Remove any covers. (→Page 8)</p>
The toilet seat and lid close on their own and then the bowl unit flushes¹	Is "Auto flush lid closed" turned ON? (→Page 30)

Auto flush lid closed¹

Trouble	Please check
"Auto flush lid closed" does not work	<p>Is "Auto flush lid closed" turned OFF? ► Set to "ON". (→Page 30)</p> <p>If "Auto flush lid closed" is turned ON: Check the "Auto flushing" and "Auto open / close" settings. (→Pages 29, 32) Even if "Auto flushing" is turned ON, "Auto flush lid closed" does not activate in the following cases.</p> <p>For about 60 seconds after the bowl unit flushes. ► After about 60 seconds have passed, use the remote control to flush the bowl unit. (→Page 19)</p> <p>When the time spent sitting on the toilet seat or standing in front of the bowl unit is less than about 6 seconds. ► Use the remote control to flush the bowl unit. (→Page 19)</p> <p>When staying in front of the bowl unit after standing and using the toilet. ► Step away from the toilet and wait for about 10 seconds.</p>

The toilet lid closes too early or too late	You can change "Auto flush delay" to modify the length of time before closing the toilet lid. (Short / Standard / Long) (→Page 30)
--	---

¹ Except TCF801EG, TCF801EAG, TCF803EG

Troubleshooting

Energy Saver

Trouble	Please check
The Energy saver LED does not light up	Has the power to the product been turned "OFF" or was there a power outage? The Energy saver LED on the main display may go off when the power is turned ON even if the energy saver feature is ON. It will turn on within about 24 hours since the setting is retained.
The timer energy saver feature is not working	Have the batteries in the remote control been replaced? "Timer energy saver" may be canceled when the batteries are replaced. ▶ Set the timer energy saver again at the time you want to start it. (→Page 29)
The auto energy saver+ or auto energy saver feature is not working	Because this function takes several days learning the usage conditions before starting energy saver, the amount of energy saving may be low, depending on the frequency of use. ▶ Check the energy saver setting. (→Pages 26, 27)

Deodorizer

Trouble	Please check
The deodorizer seems to be not working	Is "Deodorizer" set to "OFF"? ▶ Set to "ON". (→Page 35) Even after sitting down, you do not hear operation sounds. ▶ Sit down so that the seat sensor touches your skin. (→Page 9) If you hear an operation sound from the deodorizer, but odors are not removed. ▶ Clean the deodorizing filter. (→Page 43)
A strange odor is emitted	Are you using an air freshener or deodorizer that you purchased separately? Doing so may reduce the effectiveness of the product's deodorizer or cause strange odors. ▶ Remove the air freshener or deodorizer.
The auto power deodorizer feature is not working	Is "Auto power deodorizer" set to "OFF"? ▶ Set to "ON". (→Page 35) The auto power deodorizer starts about 10 seconds after you stand up from the toilet seat.

Auto bowl CLEAN

Trouble	Please check
The mist is weak	Perform Descaling mode. (→Pages 50–53)
The mist do not work	Is "Auto bowl CLEAN" set to "OFF"? ▶ Set to "ON". (→Page 34) The following functions do not work when the toilet seat is open. Is "Seat/lid" of "Auto open/close" set to "Seat+lid"? ▶ You can change it to "Lid". (→Page 33) The pre-mist does not work for about 90 seconds after the after-mist has finished. Is descaling being performed? (→Pages 50–53) ▶ The pre-mist and after-mist are not sprayed during descaling.
The mist sprays out spontaneously	When body sensor A detects someone, the "Auto bowl CLEAN" function activates and pre-mist is sprayed. ▶ You can switch "Auto bowl CLEAN" to OFF. (→Page 34) If the washing functions (e.g., Rear washing and Front washing) are not used for about 8 hours, "Auto bowl CLEAN" starts and mist is sprayed inside the bowl unit. (→Page 16)

Light

Trouble	Please check
The soft light, bowl light and CLEAN indicator do not light up	Is the "Soft light", "Bowl light", or "CLEAN indicator" turned OFF? ▶ Set to "ON". (→Pages 36, 37) If the "CLEAN indicator" does not light up, it is time for parts replacement. Consult the installer, seller, or TOTO customer service (see contact information on the back cover). Is descaling being performed? (→Pages 50–53) ▶ The LEDs inside the bowl unit do not illuminate during descaling.

Others

Trouble	Please check
Water is leaking from the plumbing connections	If any nuts in a connection are loose, firmly tighten them with a tool such as a monkey wrench. ▶ If the water leak does not stop, close the shutoff valve and consult with TOTO Service (→see contact information on the back cover).
The main unit makes a sound	When entering the bathroom If "Auto bowl CLEAN" is "ON", you may hear that pre-mist is spraying mist in the bowl unit to make it more difficult for dirt to adhere. ▶ You can turn it "OFF". (→Page 34) When sitting on the toilet seat You may hear the sound of the pump operating to warm the water up.

Troubleshooting

Others (Continued)

Trouble	Please check
The main unit makes a sound	<p>When using the washing functions (Rear washing, Soft rear washing, or Front washing) You can hear the sound of the pump operating while washing water is being supplied. You hear an operation sound at intervals of a few seconds when the washing functions is working properly.</p> <p>When moving away from the bowl unit after use If "Auto wand CLEAN" is "ON" and you use the washing functions (e.g., Rear washing and Front washing), you may hear that the wand is extended and cleaned with "EWATER+." ▶ You can turn it "OFF". (→Page 34)</p> <p>If "Auto bowl CLEAN" is "ON" and you sit on the toilet seat and use the toilet, you may hear that mist of "EWATER+" is sprayed inside the bowl unit. ▶ You can turn it "OFF". (→Page 34)</p> <p>You may hear that the wand is extended and the remaining water in the product is drained when "Auto wand CLEAN" and other functions are performed. You may hear the sound of the remaining water being drained. You may hear the fan ventilating the unit. (About 30 minutes)</p> <p>When "Auto power deodorizer" is "ON", operation sounds are made while the deodorizing power increases for 60 seconds after you stand up from the toilet seat. ▶ You can turn it "OFF". (→Page 35)</p> <p>When not using the product (e.g., at night) When "Auto wand CLEAN" or "Auto bowl CLEAN" is "ON" and the washing functions (e.g., Rear washing and Front washing) are not used for approximately 8 hours, "Auto wand CLEAN" or "Auto bowl CLEAN" will work. The following sound may be heard at that time. "Auto wand CLEAN" : Sound of cleaning the wand with "EWATER+" : Sound of extending the wand and draining remaining water from the product after operation of functions "Auto bowl CLEAN" : Sound and operating noise of spraying EWATER+ mist on the bowl unit. ▶ You can turn it "OFF". (→Page 34)</p> <p>Operating noise may occur for extending the wand to prevent damage due to freezing by discharging the water remaining within the product.</p>
"Power" LED (orange) and "Energy saver" LED (orange) on product main body are flashing	<p>If the "Power" LED (orange) and "Energy saver" LED (orange) flash at the same time, it is time to perform the Descaling mode. ▶ Perform Descaling mode. (→Pages 50–53)</p>
The main unit cannot be operated through the remote control	<p>Follow the instructions "Please check first (A–C)". (→Page 62)</p> <p>The following conditions may affect the reception performance of the remote control, resulting in not being able to operate the main unit.</p> <ul style="list-style-type: none"> • When the room size, the layout of fixtures etc. interferes • When the color of the ceiling or walls is too dark, or their shape or material interferes • When there is a rack or cabinet installed on the wall behind the main unit • When an inverter lighting system is used <p>▶ Change the position of the remote control and try again.</p>

Specifications

Item	TCF802E2G TCF802EAG TCF801EG TCF801EAG		TCF804E2G TCF803EG	
	Rated power supply	AC 220–240 V, 50 Hz		
Rated power consumption	844–854 W		848–859 W	
Maximum power consumption	1455–1468 W (When the water supply temperature is 0 °C)		1460–1475 W (When the water supply temperature is 0 °C)	
Type of water heater	Instantaneous type			
Power cord length	0.9 m			
Water protection level	IPX4			
Main unit				
Washing				
Spray volume ¹	Rear washing: Approx. 0.27–0.43 L/min Rear soft washing: Approx. 0.27–0.43 L/min Front washing: Approx. 0.29–0.43 L/min			
Water temperature	Adjustable temperature range: OFF, about 30–40 °C			
Heater capacity	1200–1428 W			
Safety device	Temperature fuse			
Backflow prevention device	Air gap (according to EN1717), Vacuum breaker			
Heated seat				
Surface temperature	Adjustable temperature range: OFF, about 28–36 °C (Auto energy saver: about 26 °C, Auto energy saver+: OFF)			
Heater capacity	55–65 W		59–71 W	
Safety device	Temperature fuse			
Deodorizer				
Method	O ₂ deodorization			
Airflow volume	Normal mode: Approx. 0.09 m ³ /min Power mode: Approx. 0.16 m ³ /min			
Power consumption	Normal mode: Approx. 1.7 W Power mode: Approx. 5.3 W			
Warm air dryer				
Warm air temperature ²	Adjustable temperature range: about 37–55 °C			
Airflow volume	Approx. 0.29 m ³ /min			
Heater capacity	200–238 W			
Safety device	Temperature fuse			
Water supply pressure	Minimum required water pressure: 0.1 MPa <dynamic>, Maximum water pressure: 1.0 MPa <static>			
Water supply temperature	0–35 °C			
Working ambient temperature	0–40 °C			
Dimensions	W 391 mm x D 579 mm x H 108 mm			
Weight	About 7 kg		About 8 kg	

*1 At 0.20 MPa (dynamic) water pressure

*2 Temperature around the warm air outlet measured by TOTO.

Safety Guidelines

A warm-water cleaning toilet seat is an electric appliance.

Continued use after malfunction occurs or use when its life-time is expired may deteriorate the electric components, producing smoke or resulting in a fire.

For safe use of the warm-water cleaning toilet seat



If any abnormality of the product is observed, stop using it and consult the installer, seller or the contact listed on the back cover of this manual.

(A damaged product may cause a fire, electric shock, or may flood the floors with water.)

•Turn off the power immediately and close the shutoff valve.

Warranty

MANUFACTURER'S GUARANTEE OF TOTO EUROPE GMBH

1. The guarantee of TOTO Europe GmbH

TOTO Europe GmbH (hereinafter referred to as "TOTO") provides a guarantee such that the products it markets shall be free of manufacturing errors in the case of normal use and service for a period of two years from the date of purchase. This guarantee only applies to ultimate consumers.

"Ultimate consumer" within the meaning of this guarantee is any natural person who has entered into a legal transaction for a purpose that can neither be attributable to their commercial nor professional activity and who does not wish to sell the product to other parties.

This guarantee does not affect the ultimate consumer's contractual or statutory rights in dealings with the affected seller and the statutory rights of the ultimate consumer in dealings with the product manufacturer.

Performed repairs that were authorised by TOTO, or any exchange of products or product parts, shall not lead to an extension of the guarantee period and furthermore shall not lead to the guarantee period starting afresh including insofar as these guarantee conditions are included with the substitute product.

2. Guarantee

TOTO provides a guarantee such that the TOTO products are free of manufacturing errors. The assessment whether or not a product is faulty is based on the level of technology at the time of manufacture.

TOTO's obligations in accordance with this guarantee are limited, at TOTO's discretion, to the repair or replacement of products or product parts that are considered faulty by TOTO on condition that such products were installed and used in accordance with the instructions for use issued in conjunction with the product and in compliance with all acknowledged demands placed on professional installation. TOTO reserves the right to conduct such investigations that appear necessary to establish the cause of the fault. TOTO shall not charge the ultimate consumer for the cost of the repair, the products or parts of products as part of repairs covered by the guarantee or products that are replaced under the guarantee.

3. Preconditions to be met to activate the guarantee

The invoice must be made available to TOTO, for example as a copy, stating the date of purchase, the invoice number, name and address of the ultimate consumer as well as the name and address of the seller for a guarantee claim to be valid. TOTO may request that the ultimate consumer provide photographs that either illustrate the damage and/or the type of connections to the power network or to the fresh and industrial water supply lines. Insofar as TOTO requests this, such photographs must also be presented to render the guarantee valid. A claim based on this guarantee takes for granted that the products for which notification of defects has been provided were installed and used properly and in accordance with the

instructions, which TOTO includes in the product delivery, and in this respect the corresponding laws and other legal provisions have been complied with.

If the ultimate consumer claims that the purchased product is faulty, in the event of purchase from an installer, the ultimate consumer is to contact such an installer. In all other cases, the ultimate consumer may contact his/her respective seller or a Service Center authorised by TOTO or contact TOTO itself. Notification of the defect is to be given within a reasonable short period once the defect is identified, at the latest however before the guarantee expires.

4. Guarantee exclusion

This guarantee does not apply to the following points:

- a) Damage or loss as a result of fire, earthquake, flood, storm or other cases of force majeure, emissions, gas damage (hydrogen sulphide), damage caused by salt or abnormal voltage,
- b) Damage or loss as a result of installation not in accordance with the conditions for use or not in accordance with acknowledged demands placed on professional installation; improper, wrong or inappropriate use or failure to follow the TOTO conditions for use or labels on the product or inappropriate product maintenance contrary to the conditions for use,
- c) Damage or loss as a result of altering, dismantling or destroying the product,
- d) Damage or loss as a result of sedimentation or foreign bodies in the water system,
- e) Damage or loss as a result of the water quality in the region in which the product is used,
- f) Damage or loss as a result of relocation following installation or due to a detrimental environment,
- g) Damage or loss caused by circumstances that do not involve the product itself, for example as a result of intervention in the building structure,
- h) Damage or loss caused by bites from animals or insects such as mice or residues of dead animals or insects,
- i) Damage or loss as a result of freezing the product,
- j) Damage or loss as a result of improper energy supply, which in terms of the voltage, frequency or safety fuses does not comply with the regulatory requirements for power supply in a household or electro-magnetic waves that are caused outside the product such as power lines and peripheral devices,
- k) Damage or loss as a result of attaching the product in moving vehicles such as cars and ships,
- l) Damage or loss as a result of using batteries etc.,
- m) Damage or loss as a result of wear-and-tear of items subject to day-to-day servicing (e.g. deodorizing filter, water drain plug),
- n) If spare parts other than original TOTO spare parts are used during repairs or maintenance of the product,
- o) The fault was caused by the transportation or installation of the product,

Warranty

- p) The product is a demonstration product/viewing product/former demonstration product/former viewing product,
- q) If consumables (e.g. filters, filter cartridges or batteries) or materials subject to customary wear-and-tear (such as seals or hoses) are affected,
- r) If the fault was caused by the breakage of brittle parts (e.g. sensor windows or small flaps),
- s) If the fault is attributable to the fact that the product damage was caused intentionally or gross negligently by the ultimate consumer or a third party.

In each individual case, TOTO shall assess whether or not the ultimate consumer has a guarantee claim. If TOTO considers the asserted claim to be justified, and examines the affected product for that reason and thereupon it becomes clear that the product was not faulty or a guarantee claim did not apply, TOTO reserves the right to invoice the ultimate consumer for the costs that arise as a result of a visit by TOTO, or a company commissioned by TOTO, to the ultimate consumer and as a result of the rendered or intended services. If the ultimate consumer can furnish proof that the ultimate consumer could not have been aware that the preconditions for a claim were not met, TOTO shall not invoice the ultimate consumer for its visit to the ultimate consumer and the rendered or intended services. In the event that TOTO does not rectify the defect based on the guarantee, TOTO shall invoice the ultimate consumer for the costs that are actually incurred (material, labour and travelling).

In the event that the ultimate consumer holds the view that he/she has additional claims as a result of other guarantees, the ultimate consumer is to establish the probable validity of its claim and TOTO shall review such claims.

5. Geographical scope of the guarantee

This guarantee is valid exclusively in the European Union, United Kingdom, Switzerland, and Turkey.

If a product is installed in a geographical location in which TOTO neither has a marketing company nor a distribution partner, in respect of reviewing the guarantee activating event the ultimate consumer is to propose an installation company that satisfies comparable quality requirements.

6. Applicable law

This guarantee is subject to the law of the Federal Republic of Germany with the exception of the requirements on application of international private law and the UN Sales Law.

THIS WRITTEN WARRANTY IS THE ONLY WARRANTY MADE BY TOTO.
REPAIR OR REPLACEMENT AS PROVIDED UNDER THIS WARRANTY SHALL BE THE EXCLUSIVE REMEDY AVAILABLE TO THE ULTIMATE CONSUMERS.
TOTO SHALL NOT BE RESPONSIBLE FOR LOSS OF USE OF THE PRODUCT OR FOR OTHER INCIDENTAL, SPECIAL, OR CONSEQUENTIAL DAMAGE OR EXPENSES INCURRED BY PURCHASER, OR FOR LABOR OR OTHER

COSTS DUE TO INSTALLATION OR REMOVAL, OR COSTS OF REPAIRS BY OTHERS, OR FOR ANY OTHER EXPENSE NOT SPECIFICALLY STATED ABOVE.

TOTO Europe GmbH
Zollhof 2 40221 Düsseldorf Germany

Important User Guidance Information



If you want to dispose this product, do not mix it with general household waste.

Dispose of this product properly according to laws and regulations in your country.

Disposed of used batteries properly.
Do not dispose of them together with general household waste.