

Dear Customers

Thank you for purchasing V-Care.

V-Care will bring a new standard to your bathrooms with its design, comfort and improved personal hygiene with refreshing water cleaning.

This manual will help you with proper use of the product and in case you have any further questions.

V-Care has been produced and developed according to European and global safety standards. However, in order to ensure correct usage and personal safety, we ask you to read the following manual carefully before your initial usage.

Please keep this manual and product warranty safe for further usage.

Contents

- 1.** Safety Instructions
- 2.** Product Overview
- 3.** Product Properties and Accessories
- 4.** Checklist Before Use
- 5.** Basic Operation Instructions
- 6.** Detailed Operation Instructions
- 7.** Additional Functions
- 8.** Public Area Usage Set-Up- RC Pairing
- 9.** Mobile App
- 10.** Basic Maintenance
- 11.** Troubleshooting
- 12.** Error Code Explanation
- 13.** Product Specification

Safety instructions

Please follow these instructions as it provides guidelines for the safe and accurate use of the product and prevents unpredicted danger or damage.

Safety Instructions are divided as follows depending on the severity of anticipated danger, damage, and the urgency of danger.



Warning

Fatal or severe injury
from improper handling



Always Execute



Caution

Injury from improper handling

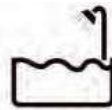

Do not
spray with
water

Do not install in
humidplaces. It may
cause fire
or electrocution.



**Never
Disassemble**

Never disassemble

Product overview

- 1.** V-Care Prime, the new generation of smart toilet from VitroA. Combines the functionality of a toilet and the cleaning properties of a bidet while offering an impressive WC design and increased comfort.
- 2.** A premium touch remote control: V-Care Prime comes with remote control, which allows the user to operate all available functions with a touch.
- 3.** Different washing options: oscillating and pulsating washing options for even more thorough cleaning effect.
- 4.** Seat / Water Temperature Adjustment: For cold winter days V-Care Prime offers seat and water temperature adjustment for more comfortable usage.
- 5.** Soft open/close seat & cover: V-Care Prime is equipped with soft-close damper system that allows the seat and cover to open and close softly.
- 6.** Stainless steel, self cleaning nozzle: V-Care Prime is equipped with stainless steel nozzle to provide the users with more sanitary washing experience. The nozzle cleans itself before and after usage to provide more sanitary environment.
- 7.** Drying Options: For more comfortable usage V-Care Prime offers drying function and also drying temperature adjustment after washing
- 8.** Sensor operated seat & cover: The seat and cover opens/closes automatically as the sensor detects the presence and/or absence of the user. The user may use the remote control to open and/or close the seat and cover.
- 9.** Auto deodorization / Odor absorption: The deodorizer automatically activates as soon as the user sits on the seat to minimize odor.
- 10.** Low temperature burn prevention: Low temperature burn prevention is equipped for the safety of elderly, children and disabled who may not be able to adjust the seat temperature easily on their own.
- 11.** Freeze prevention: With the power on, the heater automatically activates to prevent water from freezing when the water temperature drops below 5°C.
- 12.** Self diagnosis: V-Care Prime performs self diagnosis and warns the user in case of malfunction with flashing LEDs and melody.
- 13.** Decalcification: V-Care Prime is equipped with decalcification to get rid of unwanted calcium build-up periodically.
- 14.** Silent mode: The silent mode switches off the audible key sound during normal operation of the control.
- 15.** Smartphone application remote control is available.
- 16.** An ambient light is available for users comfort in the dark.



WARNING

1. When installing the product in humid places such as bathrooms, make sure to install a ventilation fan or otherwise, make sure the air is well circulated (this is to prevent the risk of fire or electrocution).
2. Make sure the electrical infrastructure has a properly working ground connection.
3. Do not connect or disconnect electric connector with wet hands (there is a risk of electrocution).
4. Disconnect electricity when cleaning (there is a risk of electrocution).
5. When assembling the water proof connector to the service wire within the wall, make sure that the grounding wire is properly connected before connecting the live and neutral wires (Inability to do so may cause product damage and/or electrocution).
6. Allow disconnection of the appliance after installation, by accessible plug or a switch in the fixed wiring, the disconnection must be incorporated in the fixed wiring in accordance with the wiring rules)
7. This appliance can be used by children aged from 8 years and above and persons with reduced physical, sensory or mental capabilities or lack of experience and knowledge if they have been given supervision or instruction concerning use of the appliance in a safe way and understand the hazards involved. Children shall not play with the appliance. Cleaning and user maintenance shall not be made by children without supervision.

 - **Do not pull the water proof connector by force.**
Damaged cords and/or connector can cause electric leakage or fire.

 - **Make sure that the cords and connectors are not damaged before use.**
Damaged plugs can cause electrocution or fire. Please consult the venton regarding repair of cords and plugs.







 - **Do not connect or disconnect the water proof connector with wet hands.**
Touching water proof connector with wet hands may cause electrocution.

 - **When discovering any abnormality such as strange smells or noises, disconnect the water proof connector.**
After checking that there is no smoke coming from the product, call the service center for repair.

 - **Do not spray water or detergent on the product and avoid using in humid areas.**
This may cause fire or electrocution.

**WARNING**

Disregarding these precautions may result in death or severe injury.

-  - **Make sure that the freeze prevention is turned on when using in cold weather.**
Freezing could damage the pipes and/or the water tank within the product, which may lead to water leakage causing electrocution.
-  - **Do not use product when any part of it is damaged.**
This may lead to injury caused by electrocution.
-  - **Do not block the dryer and/or deodorization outlet.**
This can cause fire, breakdown and noise.
-  - **For safety reasons, disconnect the product from all electricity when cleaning.**
Inability to do so may cause fire, breakdown, and electrocution.
-  - **Do not stand on the product or apply any unnecessary force on the product.**
This can cause injury or breakdowns.
-  - **Always use a service wire that has a ground line.**

**CAUTION**

Disregarding these precautions may result in injury or physical damage.

- Do not connect the product to anything other than the tap water supply.



Inability to do so may cause cystitis or dermatitis. It can also cause malfunction due to pipe blockage.

- Do not apply excessive force on the toilet seat cover.



It can cause damage to the seat cover causing injury.

- Do not excessively pull on the water supply hose.



This can cause water leakage.

- Be careful not to get your fingers caught when opening and closing the seat and cover.



- Be careful not to wet the nozzle or air outlets with urine.



This may cause an unpleasant smell or malfunction.

- When moving the product, do not hold the product by the seat or the cover.



Holding by the seat or cover alone can cause them to fall off causing injury.

- Do not operate the child mode when nobody is seating.



- If there is a power failure during the cycle after the descaling process is started, repeat the descaling process without adding the descaling fluid when the power failure is removed.



- The remote control is working with RF signal. The working signal frequency is 2.4 GHz.





PROPER USE

Following these precautions may help you prolong the product's life span and save energy.



- **Set the air and seat temperature to lower levels during hot weather.**
This may help you save electricity.



- **Keep the seat cover closed whenever possible.**
This may help you save electricity while seat heater is on.



- **Drain the water and turn the power switch "off" when leaving the house for a long time.**
This may help you save electricity and prevent the water from freezing.



- **Do not expose the product directly to the sun light.**
This may cause discoloration or make the toilet seat temperature to be uneven.



- **Keep the product away from flammable substances such as cigarettes.**
This may cause a fire.



- **Use diluted kitchen detergent when cleaning. Do not use the following substances (Toilet detergent, house detergents, benzene, thinner and powder detergent, nylon scrubber etc).**
This can cause the plastic to break and cause injury.



- **Do not put your finger or any other objects in the air outlets.**
This can cause burns or electrocution.



- **Do not flush down objects that can cause blockage such as newspapers, papers, diapers or sanitary towels.**
Items such as combs, toothbrushes, pencils will cause blockage inside. Therefore, if these are dropped, pull them out before flushing.



- **Do not connect the product to industrial water supply.**
This can cause skin inflammation.



- **Do not disassemble, repair or remodel.**
This can cause a fire or electrocution. This will also void your warranty.



- **Be careful not to wet the product and the water proof connector with water, detergent or urine.**
This can cause a fire or electrocution.



- **Disconnect the water proof connector when cleaning.**
Inability to do so could cause fire or electrocution.



- **It is recommended to use toilet paper before using dryer.**
Recommended for complete cleaning and shorter drying times.



PROPER USE

Following these precautions may help you prolong the product's life span and save energy.



- It is recommended to turn off the auto open-close seat feature for users who keep pets in residence.

Avoiding to risk of miscomfort of pets.



- Remote control must be treated gently and not to be used with sharp nails.

This can cause scratches on the remote control.



- Remote control starts blinking in case of low battery. Please replace all the batteries.

Inability to do so could lead misfunction of remote control.



- It is recommended to press the flush button before using dryer.

Prevent to spread of bad odor



- Do not throw away and keep the Water Guard part to be able to apply Decalcification Cycle later.

Product properties and accessories

WC & Seat

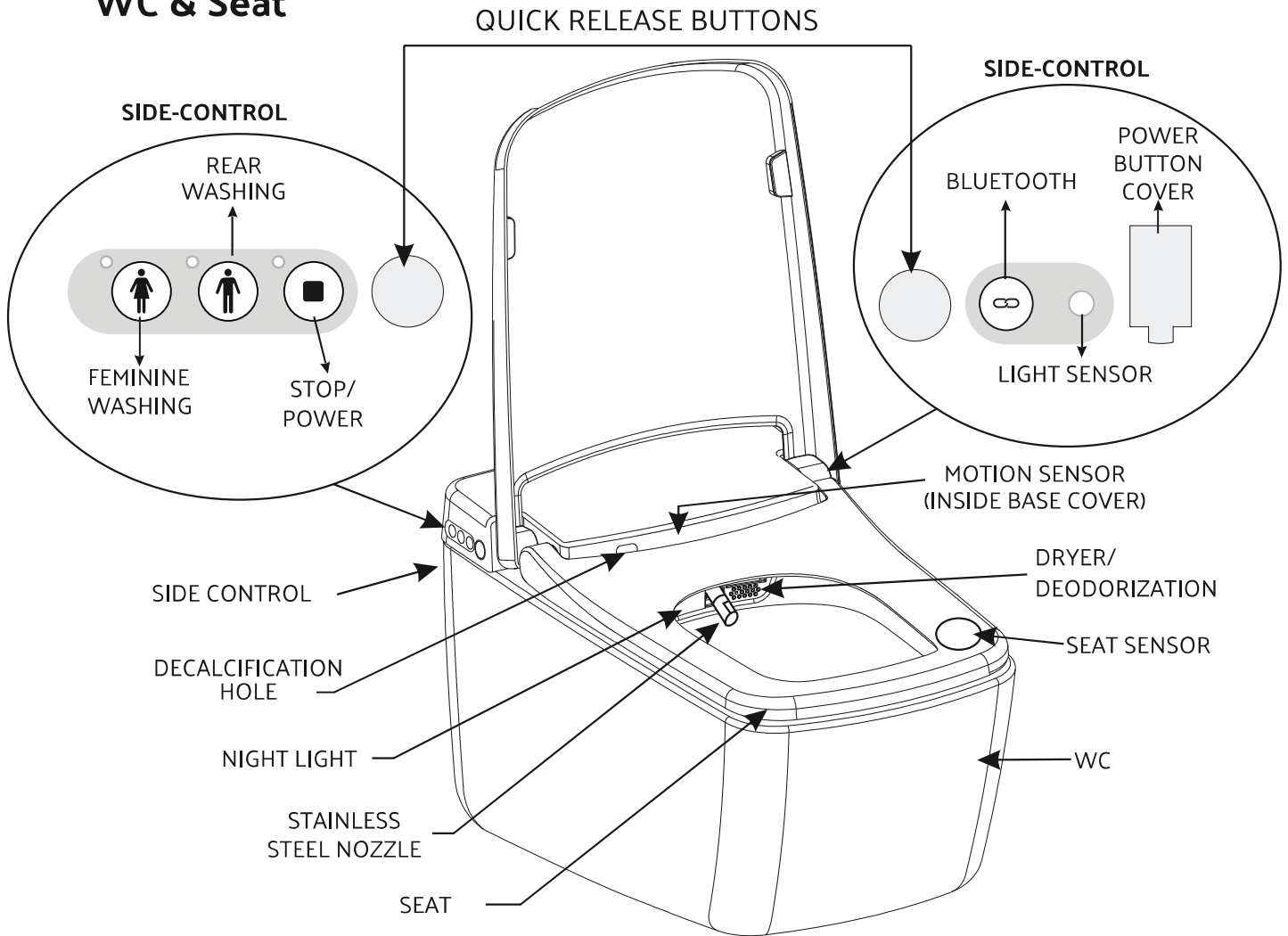

Box Contents

USER MANUAL 321110	REMOTE CONTROL 317100	WATER PROOF ELECTRIC CONNECTOR 315285	CATCH PLATE 317101	ALKALINE BATTERIES (AAA, 3EA)	WASHER CATCH PLATE 317102
FUNNEL 317010	SEAT BUFFER RISER 317103	WATER GUARD 424903	DECALCIFICATION SOLUTION 316061	DECALCIFICATION HOLE COVER 317011	MOUNTING SCREW SET 317035YP1TE

Checklist before use

Make sure that the supplied rated voltage is AC 220V~240V before connecting the water proof connector. Then turn on the power switch located at the bottom of the product.

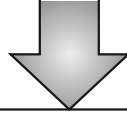

Connect the water supply hose and open the water ON/OFF valve.

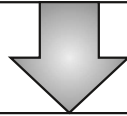

Press the rear washing and female washing button at the side control together for 3 seconds to fill up the water with water.(You will hear a beeping sound as the water starts to fill up.When doing so, do not touch the seat or sit on the seat.

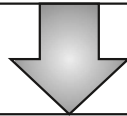

The beeping sound stops when the water is properly filled up.

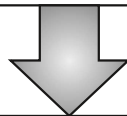

Touch the lower right part of the seat to check if the seat sensor works properly. You will hear a beeping sound when the sensor works properly.

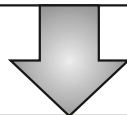

While still touching the seat, press rear washing button to check if the washing function works properly.

Note: make sure to cover the front of the nozzle so as not to be sprayed by the water coming out from the nozzle.



Basic operation instructions

Check if the power is supplied properly by checking the LED light on the .

If not, provide power by pressing POWER  button on the side control.

Sit on the seat. You will hear a beeping sound which signals that the seat has acknowledged the user.

At the same time, the deodorization will activate automatically.

After using the WC, press rear washing  or female washing  to perform desired washing.

You may change the levels of various adjustable functions as the washing function is on going.

Press stop  to end washing.

When stop  is not pressed, the on-going washing function stops automatically after 40 seconds.

Press dry  to dry the wet area.

Unless you press stop , the dryer continues to function for 3 minutes.

Detailed operation instructions

Please avoid installing the remote control directly under the three wave length lamp and/or direct sun light. Doing so may cause interference in the remote control signals.

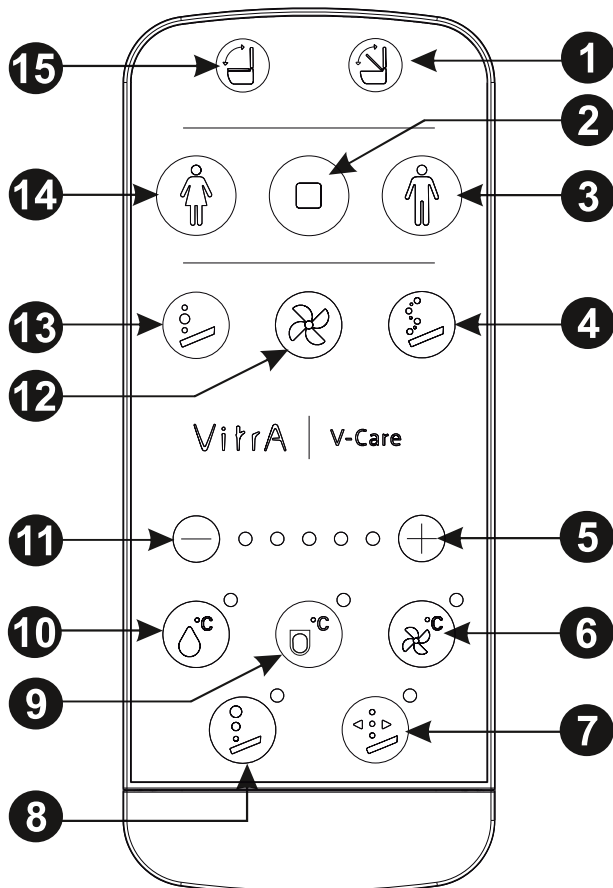

1 OPENS/CLOSES SEAT AND SEAT COVER

2 STOP

- Press to stop any on-going function.
- Press for 3 seconds to activate power saving mode.

3 REAR WASHING

- Press while sitting to eject the nozzle and begin rear washing.

4 OSCILLATING WASHING

- Press to move the nozzle rear and front for more thorough cleansing effect.

5 + (INCREASE) LEVEL ADJUSTMENT BUTTONS

- After pressing an adjustable function button, press "+" to increase the adjustable levels.

6 DRYER TEMPERATURE

- Press to adjust the dryer temperature level. Use "-" or "+" to decrease or increase dryer temperature respectively.

7 NOZZLE POSITION

- Press to adjust the nozzle position. Use "-" or "+" to shorten or elongate the nozzle length respectively.

8 WATER PRESSURE

- Press to adjust the water pressure level. Use "-" or "+" to decrease or increase water pressure respectively.

9 SEAT TEMPERATURE

- Press to adjust the seat temperature level. Use "-" or "+" to decrease or increase seat temperature respectively.

10 WATER TEMPERATURE

- Press to adjust the water temperature level. Use "-" or "+" to decrease or increase water temperature respectively.

11 - (DECREASE) LEVEL ADJUSTMENT BUTTONS

- After pressing an adjustable function button, press "-" to decrease the adjustable levels.

12 DRYER

- Press while seated to activate drying.

13 PULSATING WASHING

- Press to adjust the water pressure repeatedly from high to low to have a massaging effect.

14 FEMALE WASHING

- Press while sitting to eject the nozzle and begin female washing.

15 OPENS/CLOSES SEAT COVER

Detailed operating instructions

Rear washing While sitting, press to activate rear washing for 40 seconds.



Water pressure might become weaker if the rear washing is activated right after flushing.

Female washing While sitting, press to activate femalewashing for 40 seconds.



Water pressure might become weaker if the rear washing is activated right after flushing.

Nozzle position Press to set the level adjustment buttons to nozzle position mode. Press "+" or "-" to adjust the nozzle position as preferred.



The nozzle can be ejected in 5 different positions. The previous user's setting applies when no adjustment is made by the current user. Nozzle position is adjustable anytime during activation.

Water pressure Press to set the level adjustment buttons to water pressure mode. Press "+" or "-" to adjust the water pressure as preferred.



There are 5 water pressure levels available. The previous user's setting applies when no adjustment is made by the current user. Water temperature is adjustable anytime during activation.

Water temperature Press to set the level adjustment buttons to water temperature mode. Press "+" or "-" to adjust the water temperature as preferred.



There are 5 water temperature levels available. The previous user's setting applies when no adjustment is made by the current user.

Seat temperature Press to set the level adjustment buttons to seat temperature mode. Press "+" or "-" to adjust the seat temperature as preferred.



There are 5 seat temperature levels available. The previous user's setting applies when no adjustment is made by the current user.

Oscillating wash While washing is activated, press to initiate oscillating movement of the nozzle. This moves the nozzle back and forth for more thorough cleansing effect.



Press once more to stop.

Pulsating wash While washing is activated, press to initiate pulsating water pressure. This adjusts the water pressure from high to low repeatedly for massaging effect.



Press once more to stop.

Detailed operating instructions

Dryer While sitting, press to activate dryer to dry wet parts after washing.



Activates for 3 minutes before automatically stopping. If you wish to stop before 3 minutes is over, press stop or simply leave the seat.

Dryer temperature Press to set the level adjustment buttons to dryer temperature mode. Press "+" or "-" to adjust the dryer temperature as preferred.

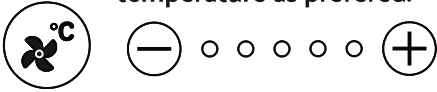

There are 5 dryer temperature levels available. The previous user's setting applies when no adjustment is made by the current user. Dryer temperature is adjustable anytime during activation.

Automatic Seat & Cover Press "seat cover" button to open and/or close the seat cover.



Depending on the seat and cover's initial position, pressing the button opens the cover or seat only and closes the seat or cover only. Seat cover closes automatically when motion sensor detects no movement for 90 seconds.

Automatic Seat & Cover Press "seat cover" button to open and/or close the seat cover.



Depending on the seat and cover's initial position, pressing the button opens the seat only or seat and cover together and closes the seat and cover together. Seat cover closes automatically when motion sensor detects no movement for 90 seconds.

Additional functions

Deodorization ON/OFF

Press to turn ON or turn OFF the automatic deodorization.

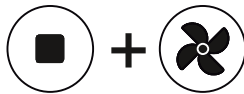

Press and hold for 3 seconds

While it's ON, deodorization automatically activates whenever the seat sensor senses the user. Then it turns off 1 minute after the user leaves the seat.

Motion sensor ON/OFF

Press to turn ON or turn OFF the motion sensor.

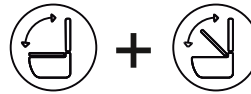

Press and hold for 3 seconds

While it's on, the seat cover opens automatically when it senses the user approach V-Care Prime. When no movement is detected for 90 seconds, both seat and seat cover closes automatically.

Nozzle Cleaning

Press rear and female washing together for 3 seconds to eject the nozzle for manual cleaning of the nozzle.

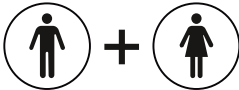

Press and hold for 3 seconds

Press stop to return the nozzle to its original position. The rear and female washing buttons on the left side-control can also be used for the same purpose.

Burn prevention

V-Care Prime is equipped with low temperature burn prevention to protect children, elderly and the disabled from burning themselves without knowing.



When seat temperature remains over 38°C for more than 10 minutes, low temperature burn prevention automatically activates to lower the seat temperature to below 38°C.

Power saving mode

Press the stop button on the remote control for 3 seconds to set V-Care Prime on power saving mode.

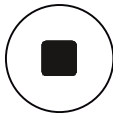

Press and hold for 3 seconds

A beeping alarm will signal the start of power saving mode. To end power saving mode, press and hold the stop button for 3 seconds again (another beeping alarm will sound to signal the end of power saving mode).

Power saving mode

When power saving mode is ON, the seat and water temperature will be automatically set to 24°C when not in use.

Power saving mode turns off automatically when the user sits on the seat, returning the temperature setting to the previous user's settings. 10 minutes after the user leaves the seat, the power saving mode turns back on to return the temperatures back to 24°C

Seat sensor

The user's skin triggers the seat sensor. When the seat sensor acknowledges the user, V-Care then goes into "ready" mode.



None of the function works while the seat is unoccupied (except for automatic seat & seat cover for Comfort version). The sensor is located on the 5 o'clock position of the seat.

Freeze prevention

V-Care Prime is equipped with freeze prevention to prevent water in the tank from freezing during cold weather.

Freeze prevention feature does not work when the power is cut off completely from power button or power outlet.

When water temperature reaches below 5°C, the freeze prevention automatically activates.

Additional functions

Battery life indication

When the battery reaches approximately **10%** of its capacity, the LED lights in the remote control blink to warn the user.



The lights on the remote control do not blink during stand by. The blinking happens only during use.

Power ON/OFF

Press the **STOP/POWER** button on the **right side-control** for **3 seconds** to turn on or turn off V-Care Prime.

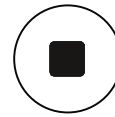

Press and hold for **3 seconds**

Turning off with the STOP/POWER button does not cut the electricity completely. To cut electricity completely, use the power switch located on the bottom left side of V-Care Prime.

Child Mode

Press **FEMALE WASH + STOP** button on the **right side-control** for **3 seconds** to perform Child Mode. (Works whether or not the sensor senses the user)



Press and hold for **3 seconds**

Performs for 40 seconds with oscillation at level 1 water pressure and level 5 nozzle length.

Decalcification Cycle

Press **WATER TEMP+SEAT TEMP** button on the remote control for **3 seconds** to perform Decalcification. (Works only when there is no one sitting on the seat)



Press and hold for **3 seconds**

None of the other function works during Decalcification process.

Silent Mode

Press **NOZZLE POSITION+ WATER PRESSURE** button on the remote control for **3 seconds** to go into Silent Mode



Press and hold for **3 seconds**

To stop Silent Mode, press NOZZLE POSITION+ WATER PRESSURE buttons on the remote control for 3 seconds again.

Connectivity

Please start pairing by opening mobile application and follow the steps described by mobile application

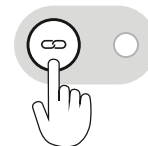

Ambiance Light

Press **OSCILLATION + PULSATION** button on the remote control for **3 seconds** to close Ambiance Light and stop the usage.



Press and hold for **3 seconds**

Please repeat the same sequence to start the Ambiance Light usage.

Quick Release

Press the quick release buttons together on the right and left side control panel to move the main unit through upside.

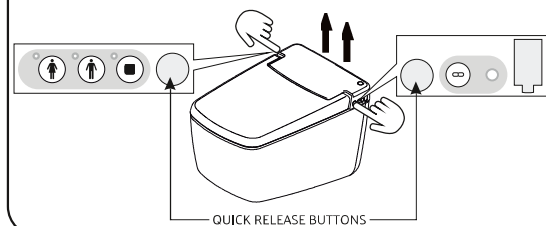

QUICK RELEASE BUTTONS

Public area usage setup- RC Pairing

RC Pairing

This product used radio frequency for communication between the main unit and the remote control.

So pairing between the main unit and the remote control is necessary.

Remote control is designated with an ID code and the pairing allows the remote control to imprint it's ID to the main unit.

Step 1. Press and hold STOP + FRONT WASH buttons on the side control for 3 seconds.

Be noted that when setting ID, no one should be sitting on the product. There will be a beep and green LED

on the STOP button in the side control will blink. This means that the product is in RC Pairing mode.

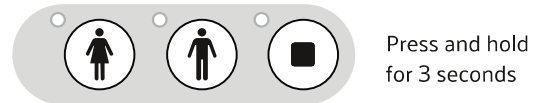

Step 2. Press and hold + and - buttons on the remote control for 3 secs.



When setting completed the entire level indicator on the remote control will blink 3 times.



A single beeping sound will indicate that the RC Pairing is completed.

Mobile App

The mobile app offers additional benefits such as comfort, usage data display, remote control and updating. The status of the V-Care Smart Toilet Prime can be monitored and controlled via the mobile app anywhere with a network connection.

The mobile app proffers the user optimum functionality and performance.

Connectivity

V-Care Smart Toilet Prime has secure access encrypted over local network and mobile.

Thanks to the network connection, the V-Care Smart Toilet Prime firmware always remains up to date. The local network supported internet access function allows you to remotely monitor and control your product.



Download

The V-Care Smart Toilet Prime Mobile App is available for IOS and Anroid platforms. Go to your application store to download to your mobile phone and run the application after download.



Create Vitra user account

For additional benefits such as ease of use, comfort and increased hygiene in the toilet, please create a Vitra user account. The application lets you to create your account.



Network setup

To set-up a network connection your Smart Toilet Prime is vital to take the advantage of remote access, software upgrades, recommendations for more efficient use, and local announcement notification.



Pair your device

Following creating user account, mobile app directs you to pair your device and your mobile phone. Please folow the instructions given by mobile app.



Explore your app

Experience the V-Care Smart Toilet Prime Mobile App that widens the limits of time and place with extended control features.

Basic maintenance

How to apply decalcification cycle

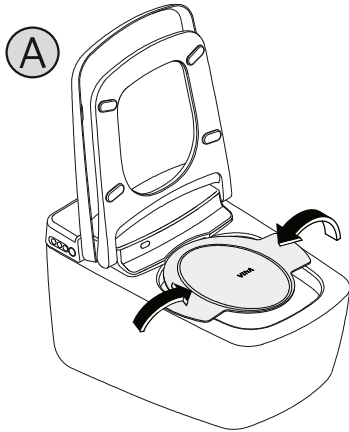

Place WATER GUARD between the seat and WC. (A)

Press WATER TEMP+SEAT TEMP  +  buttons on the remote control for 3 seconds to start Decalcification. (A single beeping sound will start from this moment)

Nozzle will be extracted. Then water will be dumped through the nozzle into the bowl for 20 seconds.

When water dumping stops, (B) open the Decalcification cover and (C) insert funnel through the opening.

(D) Pour the entire decalcification solution into the funnel slowly and remove the funnel when pouring is finished, close the cover.

(A double beeping sound will start from this moment)

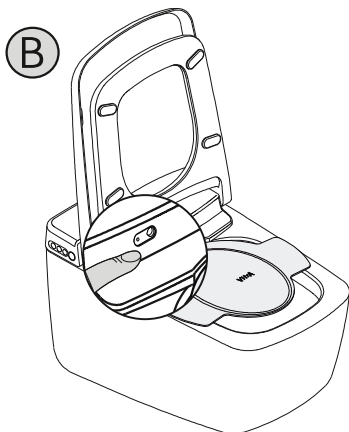

Wait for about 3 minutes. During this time, the decalcification solution will soften the calcium build-up within the tank.

After 3 minutes up, V-Care Prime will perform the following: 3 cycles each of 40 seconds of REAR WASHING + 40 seconds of FEMALE WASHING + 40 seconds of NOZZLE CLEANSING.

(A single beeping sound will start from this moment)



Nozzle retracts to its' original position and decalcification is concluded. Remove the water guard. (The beeping sound stops) The complete descaling process does not take longer than 10 minutes.

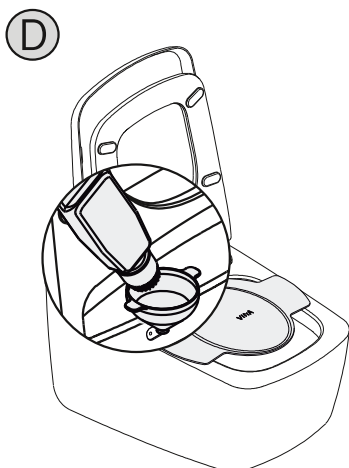

- Do not pour more than one bottle (125 ml) decalcification solution inside the product for one decalcification cycle.
- Clean remaining water on the product after decalcification cycle with a soft cloth.
- Do not use sharp objects for opening decalcification hole cover.
- Decalcification cycle must be applied every four months (3 times) in a year.
- Please clean the funnel with water before decalcification cycle application to prevent dust, dirt etc.
- Do not use any liquid other than the Durgol descaling agent supplied with the product.

Basic maintenance

How to clean the main unit



- ① Soak a soft cloth in water and squeeze the cloth hard to rid of excessive water.
- ② Clean dirty areas by putting small amount of neutral detergent on the cloth and wiping the area.
- ③ Polish the cleaned area with separate dry cloth to finish.



Remember the following when cleaning V-Care Prime.

- a. Do not use acid or alkaline detergents as this could cause rust on the metal parts.
- b. Toilet detergents can damage the plastic part of the product because of the volatile gas in the substance. When cleaning with toilet detergents, finish cleaning quickly and keep the seat cover open after cleaning.
- c. Make sure that the toilet detergent does not get on the plastic part of the product.

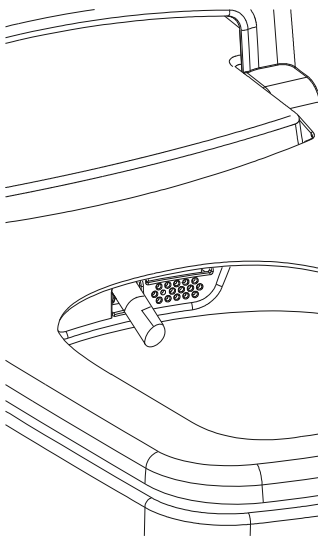

- ① Press rear washing and female washing together for 3 seconds to eject the nozzle for manual cleaning.
- ② Wipe the nozzle softly using a soft cloth.
 - Be careful not to damage the nozzle hole.
 - Do not use cloths with rough surface.
 - Open the seat and toilet cover.
 - Hold the nozzle lightly when cleaning.
- ③ Press stop button on the remote control to return the nozzle to its original position.
If stop button is not pressed, the nozzle goes back to its original position 3 minutes after it is ejected.

- You may also call on you service provider to change the tip of the nozzle when you feel necessary.”

Changing batteries

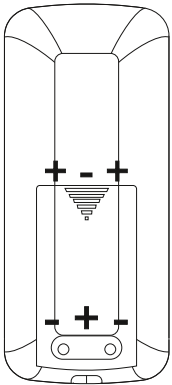

- ① Remove the remote control from the hanger.
- ② Remove the battery cover at the back of the remote control by lightly pushing and sliding the cover downwards.
- ③ Remove the drained batteries and change them with new ones.
Make sure to insert the batteries in the correct polarity. Use alkaline batteries(LR03 AAA) for longer battery life span.

Solenoid Valve Maintenance

- ① The solenoid valve used in the product must be replaced by the authorized service every 10 years.

Recycling

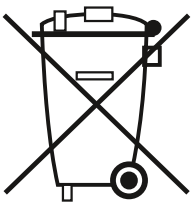

This marking shown on the product or its literature, indicates that it should not be disposed with other household wastes at the end of its working life. To prevent possible harm to the environment or human health from uncontrolled waste disposal, please separate this from other types of wastes and recycle it responsibly to promote the sustainable reuse of material resources.

Household users should contact either the retailer where they purchased this product, or their local government office, for details of where and how they can take this item for environmentally safe recycling.

Business users should contact their supplier and check the terms and conditions of purchase contract. This product should not be mixed with other commercial wastes for disposal.

Troubleshooting

SYMPTOMS	THINGS TO CHECK
When the STOP/POWER button's LED light on the left side-control is turned OFF and the washing functions are not working.	<ul style="list-style-type: none"> • Isn't there a brown out or black out? • Check if you can turn on the unit by pressing STOP/POWER button for 3 seconds. • Is the power switch at the bottom right side of the unit turned on? • Is the water proof connector connected properly?
When the STOP/POWER button's LED light on the left side-control is turned ON but the washing functions are not working.	<ul style="list-style-type: none"> • Are you sitting on the seat? Remember that you have to be sitting on the seat for washing functions to activate. • Are you seated properly and not leaning too much towards one side? • Is there enough power in your batteries of the remote control? • Isn't the transmitting area of the remote control blocked? • Isn't the receiving area of the main unit blocked?
When the water or seat temperature is too low.	<ul style="list-style-type: none"> • Are the temperature adjustments turned on?(for the water temperature) • Is the unit turned on?(for the seat temperature)
When the water from the nozzle does not flow or flows weakly.	<ul style="list-style-type: none"> • Is the water pressure in your area strong enough? • Isn't there any unwanted substance stuck in the tip of the nozzles? • Is the water supply valve fully opened? • Isn't the water supply hose(flexible hose) bent? • Is there any unwanted substance stuck in the water-supply valve or hose?
When there is water leakage.	<ul style="list-style-type: none"> • Is there a leak in the connection between water supply pipe and the main unit? • Is the water supply hose leaking, bent or damaged?
When the remote control does not work or the LED lights does not turn on.	<ul style="list-style-type: none"> • Are there enough power left in the remote control batteries? • Are all the batteries properly inserted on the correct polarity? • Are there anything blocking the transmitter or the receiver of the remote control?

• In the next instances, please disconnect the water proof connector and call your service provider for assistance.

- The main unit makes beeping alarms and does not function.

- The water temperature constantly stays cold even when adjusted to be warm.

- When the remote control is dropped in water.

- There is a constant leak within the main unit.

* Do not interfere the product if there is broken apart. Do not allow water leakage through the broken area and call authorized service.

Error code explanation

Error Code Definition	Error Code Led Indicator
Water temperature sensor error	Warning signal beeping sound + Flashing rear washing LED (Left side control unit)
Seat temperature sensor error	Warning signal beeping sound + Flashing front washing LED (Left side control unit)
Water supply error	Flashing rear washing LED + Flashing front washing LED (Left side control unit) (Occurs when water tank is not filled properly within 1 min 30sec after use)
Water level sensor error	Flashing Power / Stop LED (Left side control unit)
Toilet seat or cover auto open/close motor error	LED flashing white (Right side control unit) (Flashing white: Cover damper, Seat Damper)

- If you see any of the above errors, please contact the authorized service.

Product specification

Product name		VitrA V-Care Prime		
Model name		V-Care Prime 7231/431530 (PRIME)	V-Care Prime 7232/431530 (PRIME)	
Rating voltage & frequency		AC 220V~240V , 50/60Hz		
Maximum power consumption		714~846W		
Needed water supply pressure		0.7~7.5kgf/cm ² (0.069MPa~0.735MPa)		
Product size		(W) 380mm X (D) 602mm X (H) 315mm		
Weight		5.5Kg		
Washing function	Water tank capacity	760cc		
	Nozzle type	Motor operated one Way Nozzle (Integrated water way for both female and rear washing)		
	Nozzle adjustment levels	5 levels available		
	Washing type	Combination of water pump and air pump		
	Water consumption	Female	Max 720cc/min (480cc/40sec)	
		Rear	Max 720cc/min (480cc/40sec)	
	Water pressure adjustment	5 levels available		
	Water heater power consumption	641~763W		
	Water temp adjustment	6 levels available(OFF, 32°C - 34°C - 36°C - 38°C - 40°C)		
	Safety equipment	Automatic resetting thermostat(50°C: off, 40°C: on),Thermal Fuse (53°C), Water level Sensor,Thermistor		
Others	Oscillating, Pulsating wash, Freeze prevention			
Drying	Drying temp adjustment	5 levels available(OFF,1-5 level)		
	Heater power consumption	200~238W		
	Safety equipment	Resetting bimetal(105°C) Thermal fuse(195°C)		
Heated seat	Seat temp adjustment	6 levels available(OFF,32°C - 34°C - 36°C - 38°C - 40°C)		
	Seat heater capacity	50~60W		
	Safety equipment	Thermal Fuse(72°C),Thermistor		
	Others	Low temperature burn prevention, Seat sensor(Electrostatic touch type)		
Additional functions	Remote	RF (2.4GHz) Type		
	App. Control	Bluetooth 4.2, Wifi 802.11b/g/n		
	Electronic damper	Automatic opening/closing seat & seat cover		
	Circuit breaker	Built-in circuit breaker (15mA within 0.1 sec)		
	Power saving	1 level available		
	Power ON/OFF	2 available (One to turn on/off the unit, the other to cut-off electricity completely)		
	Freeze protection	Turns on automatically when the water temperature drops below 5°C.		
	Nozzle cleaning	2 available (Automatic cleansing before and after every use and manual cleaning)		
Deodorization	Activated carbon filter			