

VitrA

VitrA V-Care Smart Toilet

The ultimate personal hygiene experience



VitrA

We progressively invest in essentially human spaces - the bathrooms.



The complete bathroom

VitrA designs and produces bathrooms that understand and satisfy both physical and emotional needs. The result is a complete bathroom that perfectly captures a coherent harmony between all the individual elements.



Inspiration for change

Making change in the bathroom begins with understanding human needs and desires, coupled with the creation of new and attractive choices. This results in a wealth of inspiration that gives consumers confidence to make the best decisions.

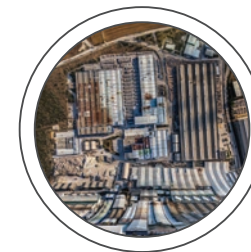

High powered perfection

Seven state-of-the-art factories around the world create and produce sophisticated ceramics, furniture, faucets and tiles, and maintain world-class standards - whilst progressively reducing Vitra's ecological footprint.



Collaboration with designers

VitrA works with acclaimed designers internally, and also around the world. Not only does the collaboration with this top talent improve product functionality, but it also introduces more creativity and originality.



VitrA's global footprint

VitrA's world-class bathroom designs are admired by customers around the world, through 2000 sales points, in over 75 countries, including 150 exclusive Vitra showrooms in Istanbul, London, Cologne, Moscow, Dubai, Mumbai, Delhi..



Innovation with style

The Vitra Innovation Centre serves as the headquarters of the brand's R&D activities, with a strong engineering team, leading the bathroom industry with human-centric solutions and technology.



Improved personal hygiene

Informed by extensive research, Vitra continuously improves its in-depth expertise in hygiene and cleanliness in the bathroom. These innovative technologies enhance human health and elevate the personal hygiene experience to new levels.



Bathrooms for our Planet

VitrA is committed to work for a sustainable future in all activities and to protect the balance of the environment, resources, society and business and follows the same approach across people, products, and production.

Index

Water directed by technology	6-7
V-Care Smart Toilets	8-9
V-Care Smart Toilet Prime	10-13
Personal hygiene features	14-15
Comfort features	16-17
Comfort at your fingertips	18-19
V-Care Smart Toilets Comfort & Basic	20-21
Comfort and Basic features	22-23
Features to perfect experience	24-33
Technical information	34-49

Water directed by technology

Our toilets with an integrated bidet function provide gentle and thorough personal water-based cleansing, while also reducing the amount of toilet paper you use. Personal cleansing with water offers more effective hygiene without irritating your skin, compared to using toilet paper. In addition to the relaxing and hygienic features of the Vitra V-Care series, it also takes your toilet experience to the next level with its heated seat, dryer, and control numerous features controlled via remote or mobile app.



VitrA V-Care Smart Toilets offer the best options to answer your water-based cleansing needs, with three variants: Prime, Comfort and Basic.



Prime



Comfort



Basic

A smart toilet engineered as a design icon

Designed by Arik Levy in collaboration with the Design Studio Vitra and Innovation Center, the V-Care Smart Toilet Prime exemplifies the perfect integration of bathroom design and sophisticated technology, which pampers while it delivers the ultimate in personal hygiene.

Prime





The V-Care Smart Toilet Prime is available in two variants: wall-hung and floor-standing

V-Care Smart Toilet Prime Personal hygiene features

Every detail is designed for personal hygiene and well-being.

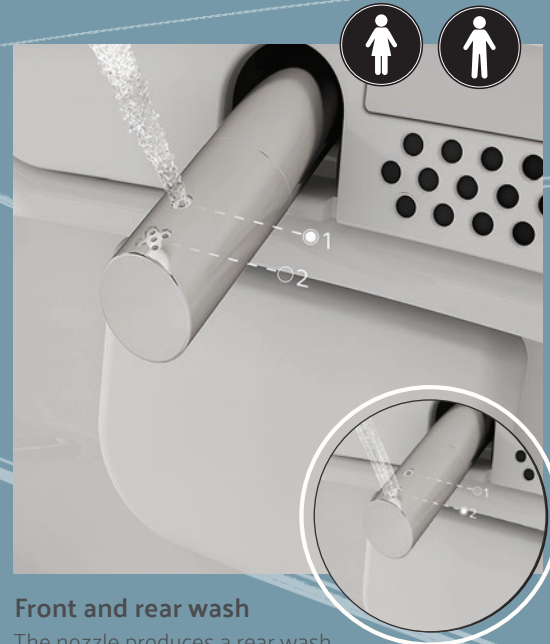
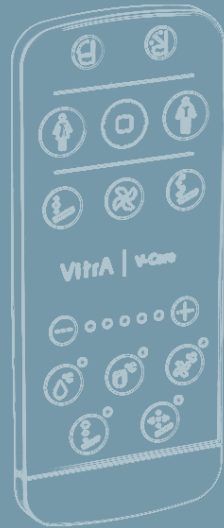

Front and rear wash

The nozzle produces a rear wash suitable for all, as well as a gentler front wash as a bidet for women.



Adjustable nozzle position

Perfect cleansing by adjusting the nozzle back and forth.



Adjustable water temperature

Five different water temperature settings offer a more comfortable cleansing ritual.

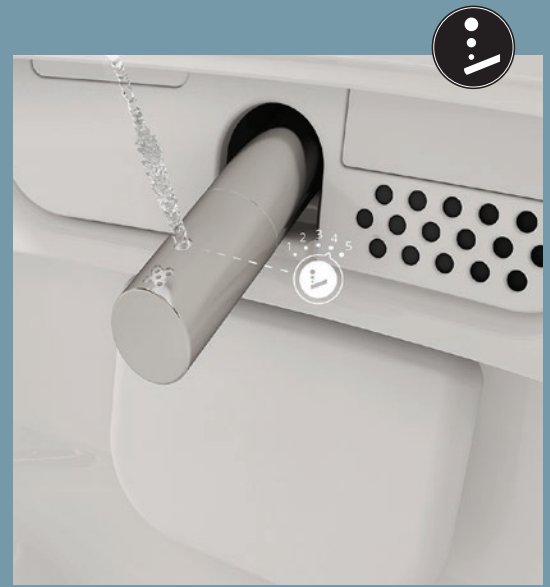

Adjustable water pressure

Five different levels of water pressure offer a thorough and pampering wash.



Oscillating wash

The bidet nozzle moves back and forth for a thorough clean over a larger area.

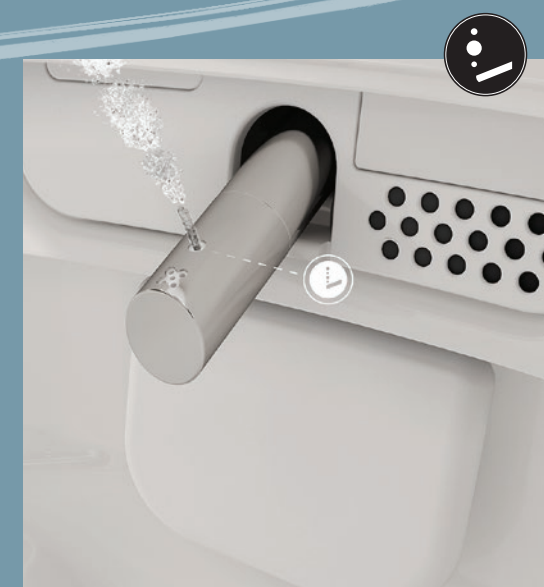

Massage wash

The water pressure alternates between gentle and firm for a massaging wash.

V-Care Smart Toilet Prime Comfort features

Every detail is designed for comfort.

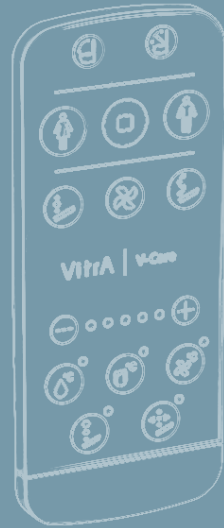

Adjustable seat temperature

The seat has a choice of five temperature settings to complete your comfort.



Auto open/close lid

The motion sensor automatically raises the lid on detecting your approach, eliminating the need to touch it.



Open/close lid and seat

The lid and seat can also be opened and closed by remote control or mobile app, with no need to touch the seat.



Dryer and adjustable air temperature

After washing, the warm-air dryer provides fast and gentle drying. Also, free yourself from toilet roll. Five different levels of air temperature settings offer more comfortable drying.

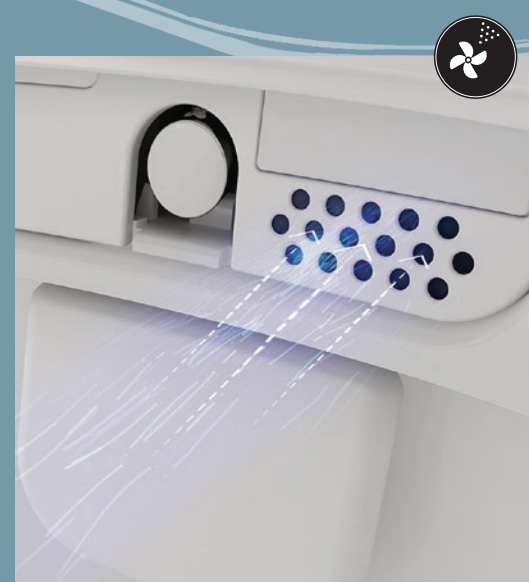

Air purification

Thanks to powerful deodoriser filters, the air is freshened around the toilet.



Night light

The LED night light is automatically activated when the ambient light levels fall.

Comfort at your fingertips

VitrA V-Care Smart Toilet Prime enhances your toilet experience with technology, including remote control and a mobile app. It provides full control of your hygiene with its touch-free use and keeps your personalised settings for V-Care in the app.

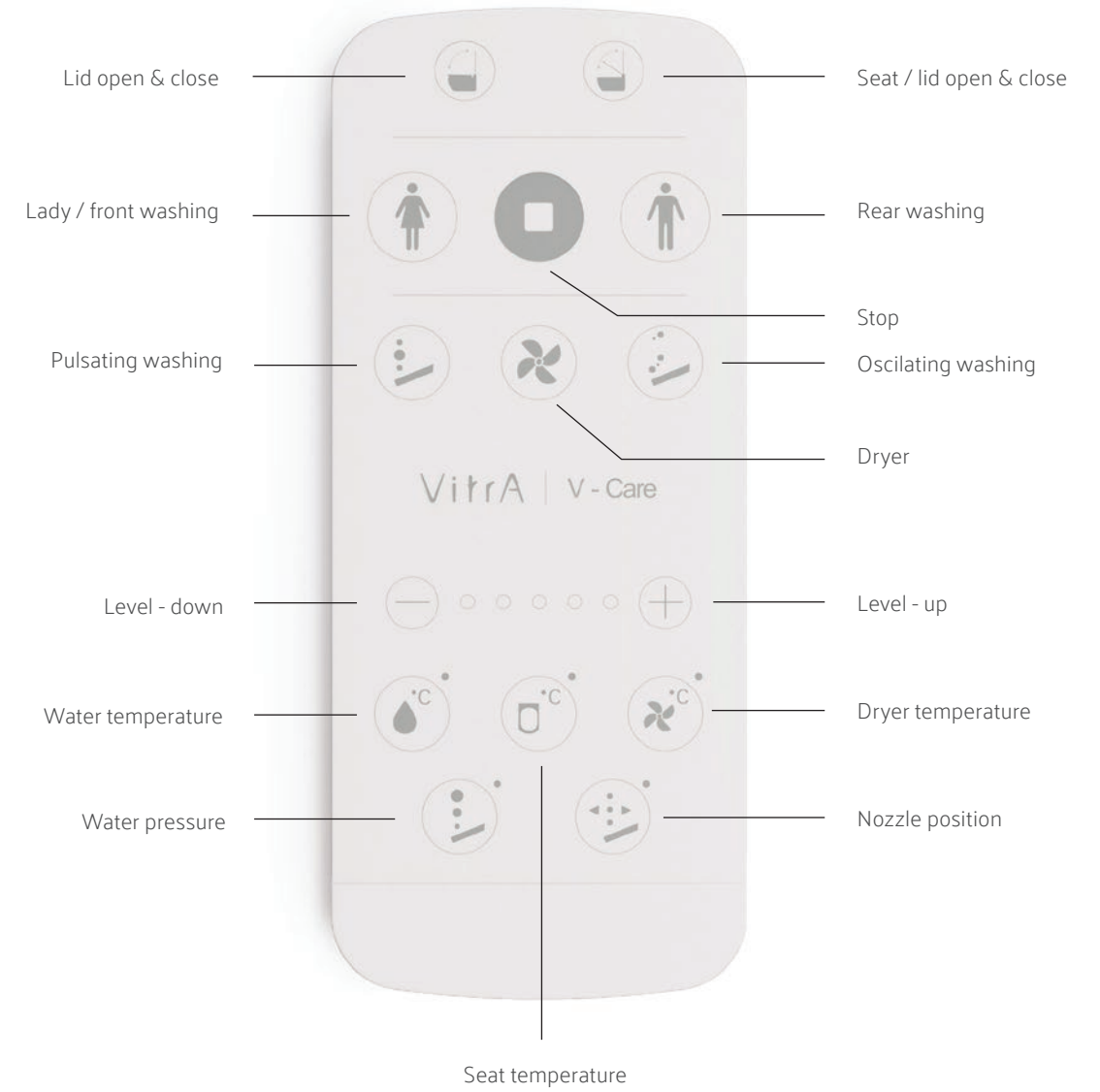

A fully customisable hygiene experience

Designed by Noa in collaboration with the Design Studio Vitra and Innovation Center, the V-Care Smart Toilet offers you a user-friendly and fully customisable personal hygiene experience. The V-Care Smart Toilet is available in two variants: Comfort and Basic

Comfort & Basic



VitrA
V-Care Smart Toilet
Comfort & Basic features



Basic version



Comfort version



Features to perfect experience

VitrA's standards exist to advance and enhance your toilet experience.



VitrA Hygiene



VitrA Rim-ex



VitrA Concealed Installation



Ion-rich technology that inhibits the growth of harmful bacteria

VitrA Hygiene, which coats all VitrA ceramicware, inhibits the growth of harmful bacteria by 99.9%. By disrupting the cellular structure of bacteria that cling to the surface during use, this proprietary glaze prevents them from proliferating into a colony.

Tests in accordance with the national and universal ISO 22196, JIS Z 2801, ASTM E 3031-15, and TSE 13420 protocols have verified the efficacy of VitrA Hygiene against gram negative (*Escherichia coli*) and gram positive (*Staphylococcus aureus*) strains.

The VitrA Hygiene glaze coats all external and internal surfaces prior to firing in a process that ensures lifetime VitrA Hygiene protection for VitrA ceramic sanitaryware even under the most intense usage conditions.

Fewer chemicals and better hygiene with VitrA Hygiene

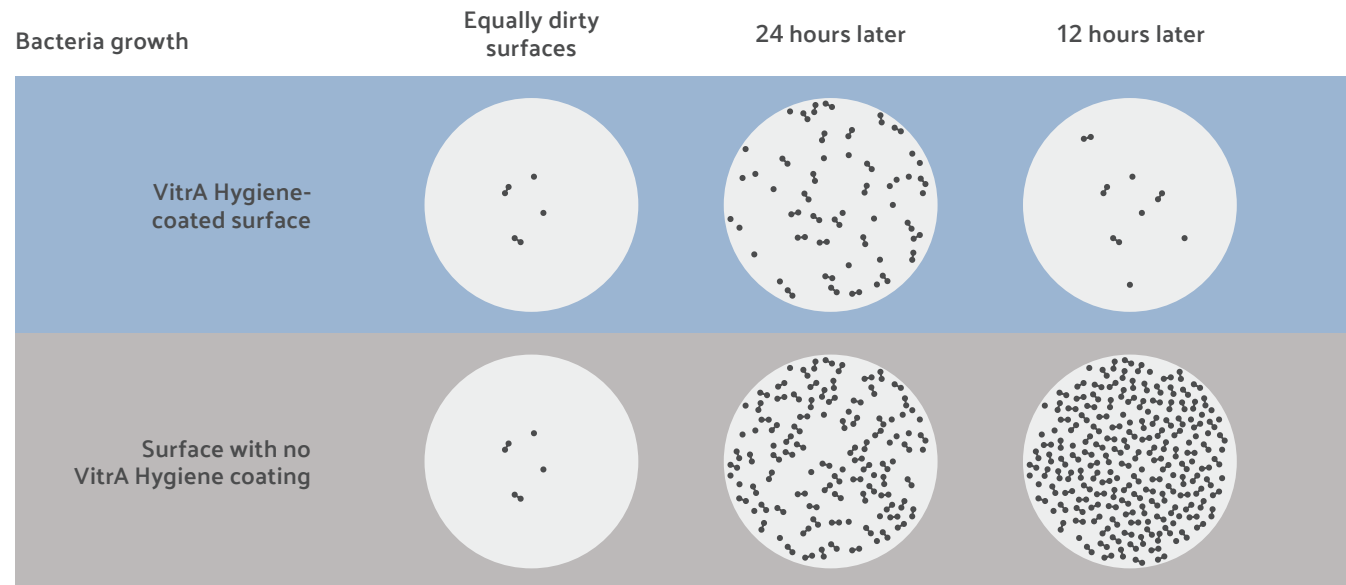



Rimless WC that leaves no room for dirt

The Vitra Rim-ex system flushes every part of the Vitra wall-hung WC bowl, leaving bacteria nowhere to hide. Free of the channels that can harbour harmful bacteria and micro-organisms, the Vitra Rim-ex toilet is easier to clean and 95% more hygienic than standard pans. The triple-nozzle diverter and the smooth curvature of the bowl give a thorough and 25% more hygienic flush each time. **Tests undertaken by Akdeniz University show that Rim-ex is easier to clean and 95% more hygienic than standard WC pans.



Channel-free WC bowl



Standard WC bowl with a channel





Design that makes cleaning easy

Concealed installation is one of several ideas that ensure lasting hygiene for the Vitra wall-hung WC. The recessed installation detail and screws at the sides of standard wall-hung toilets are taken into the interior of Vitra wall-hung WC's. This leaves nowhere for dirt to hide and simplifies the cleaning of the entire surface.



WC with concealed installation



WC with standard installation





Easy to install, easy to maintain

Hidden plumbing and power connections simplify installation and make the Vitra Smart Toilets very easy to clean. Equipped with a limescale reducer, the Vitra Smart Toilets are suitable for use across the world from the hardest water areas through to the softest.



Refreshingly clean

V-Care Smart Toilets comply with DIN EN 1717 regulations to ensure your household water supply does not become contaminated.

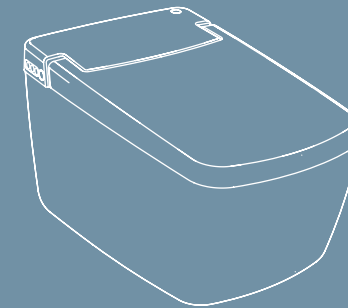

7231B403-6216
V-Care Prime Wall-Hung WC

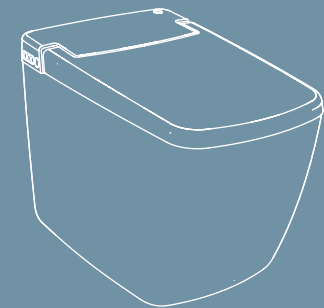

7232B403-6217
V-Care Prime Floor-standing
Back to wall WC

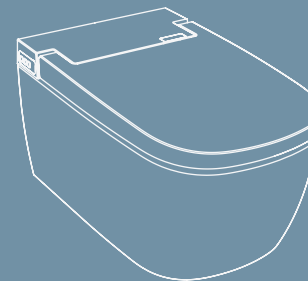

5674B403-6194
V-Care Comfort Wall-Hung WC

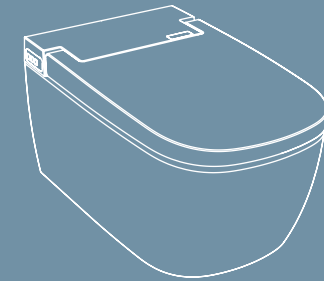

5674B403-6193
V-Care Basic Wall-Hung WC

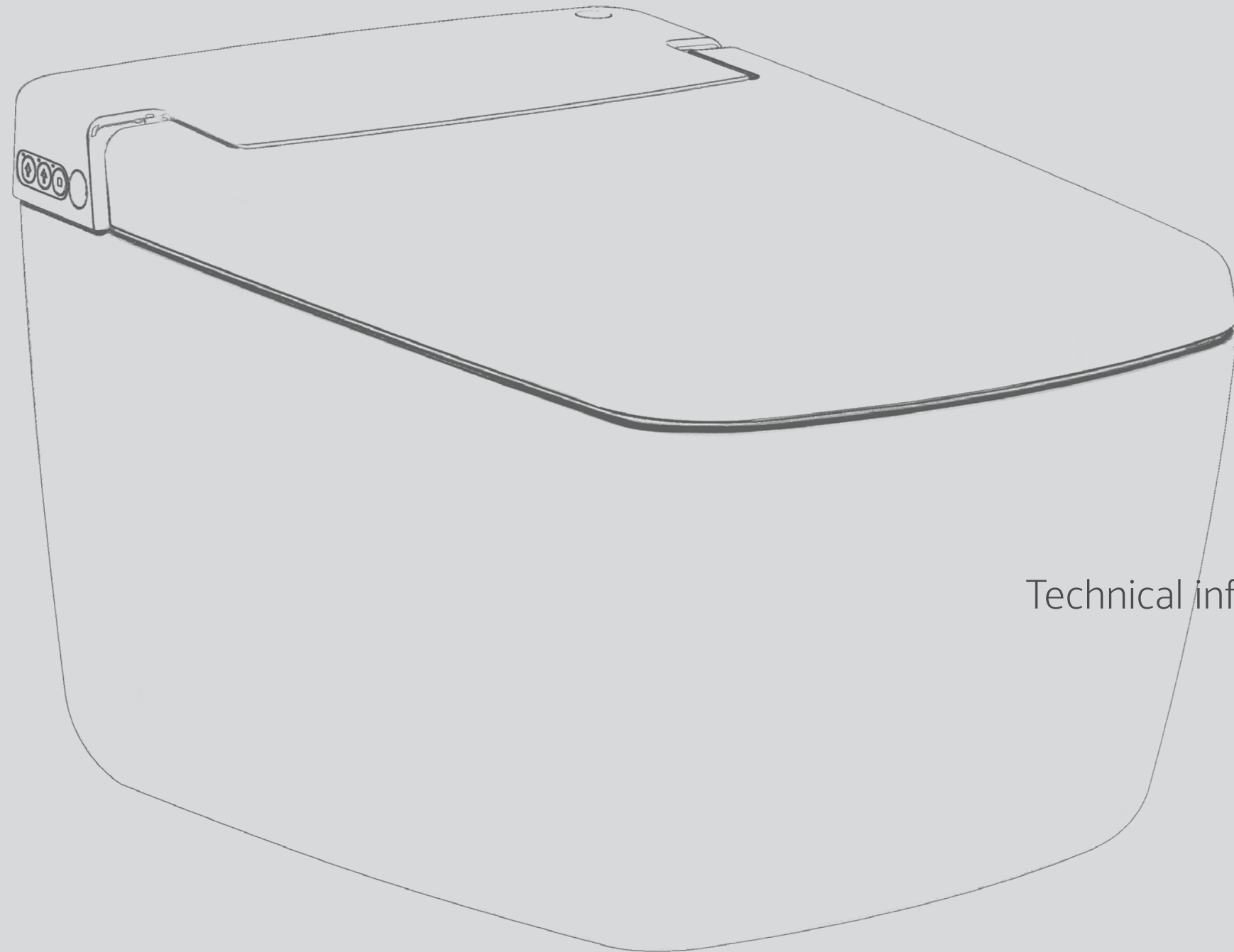
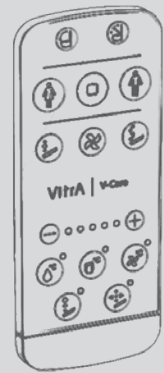

Technical information

V-Care Smart Toilets



	Features	Prime Wall-Hung	Prime Floor-standing
Personal Hygiene	Rear Wash	✓	✓
	Front Wash (Lady Wash)	✓	✓
	Oscillating Washing	✓	✓
	Pulsating Washing (Massage Wash)	✓	✓
	Removable Nozzle	✓	✓
	Nozzle Position Adjustment	5 levels	5 levels
	Adjustable Water Pressure	5 levels	5 levels
	Heated Water	✓	✓
	Adjustable Water Temperature	5 levels	5 levels
Comfort	Warm Air Dryer	✓	✓
	Adjustable Dryer Temperature	5 levels	5 levels
	Air Purification	✓	✓
	Heated Seat	✓	✓
	Adjustable Seat Temperature	5 levels	5 levels
	Auto Open/Close Seat & Lid	✓	✓
	Soft-Close Seat & Lid	✓	✓
	Remote Control	✓	✓
	V-Care Smart Toilet App	✓	✓
Night Light	✓	✓	
Hygiene	VitrA Rim-Ex	✓	✓
	VitrA Hygiene	✓	✓
	VitrA Clean	✓	✓
	Nozzle Self-Cleaning	✓	✓
	Quick Release System	✓	✓
Additional Features	Silent Mode	✓	✓
	Child Mode	✓	✓
	Power Saving Mode	✓	✓
	Descaling Mode	✓	✓
	Diagnostics Function	✓	✓
	Concealed Electricity & Water Connection	✓	✓
Technical Data	EN1717 Compatibility	✓	✓
	Seat & Lid Material	Nuvoplast	Nuvoplast
	Bluetooth	Bluetooth 4.2	Bluetooth 4.2
	Wi-Fi	802.11b/g/n	802.11b/g/n
	Power Supply	220 - 240 V AC	220 - 240 V AC
	Frequency	50 / 60 Hz	50 / 60 Hz
	Water Pressure	0.069 MPa - 0.735 Mpa	0.069 MPa - 0.735 Mpa
	Flush water volume	3 / 6 L	3 / 6 L
	Max Power Consumption	714~846W	714~846W
	Water Temperature	30°C-42°C	30°C-42°C
	Seat Temperature	30°C-42°C	30°C-42°C
	Dryer Temperature	12°C-38°C	12°C-38°C



	Comfort Wall-Hung	Basic Wall-Hung
Personal Hygiene	✓	
	✓	✓
	✓	
	✓	
	✓	✓
	5 levels	5 levels
	5 levels	5 levels
	✓	✓
	5 levels	5 levels
Comfort	✓	
	5 levels	
	✓	✓
	✓	✓
	5 levels	5 levels
	✓	
	✓	✓
	✓	✓
Hygiene	✓	✓
	✓	✓
	✓	✓
	✓	✓
	✓	✓
Additional Features	✓	✓
	✓	✓
	✓	✓
	✓	✓
	✓	✓
	✓	✓
Technical Data	✓	✓
	Nuvoplast	Nuvoplast
	220 - 240 V AC	220 - 240 V AC
	50 / 60 Hz	50 / 60 Hz
	0.069 MPa - 0.735 Mpa	0.069 MPa - 0.735 Mpa
	3 / 6 L	3 / 6 L
	714~846W	714~846W
	30°C-42°C	30°C-42°C
	30°C-42°C	30°C-42°C
	12°C-38°C	

VitrA



Prime

V-Care Prime Wall-Hung WC
7231B403-6216



WxDxH (mm): 390x620x410
Rim-ex
Concealed water inlet (1/2 ")
Nuvoplast seat

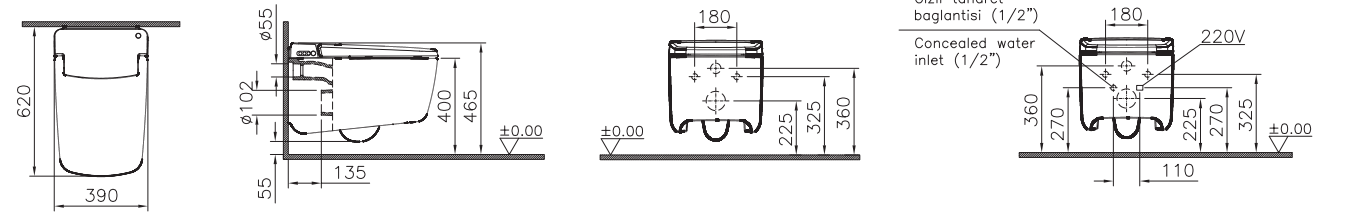

V-Care Prime Floor-standing Back to wall WC
7232B403-6217



WxDxH (mm): 390x620x465
Rim-ex
Universal outlet
Concealed water inlet (1/2 ")
Nuvoplast seat

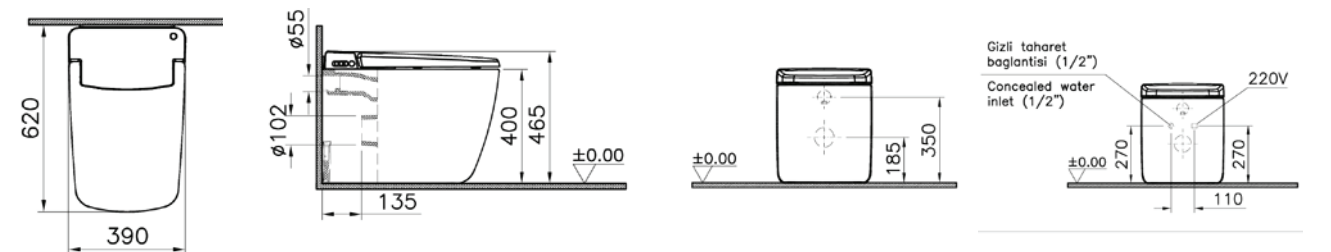

VitrA



Comfort & Basic



V-Care Comfort Wall-Hung WC
5674B403-6194

WxDxH (mm): 398x600x415
Rim-ex
Concealed water inlet (1/2 ")
Nuvoplast seat

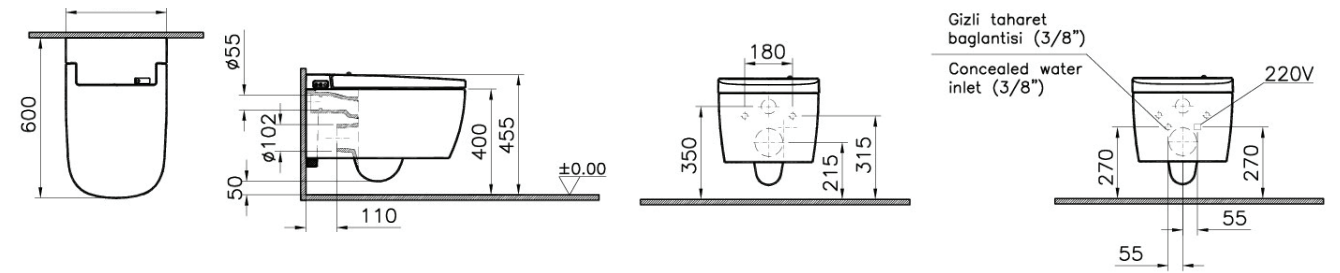

V-Care Basic Wall-Hung WC
5674B403-6193

WxDxH (mm): 398x600x415
Rim-ex
Concealed water inlet (1/2 ")
Nuvoplast seat

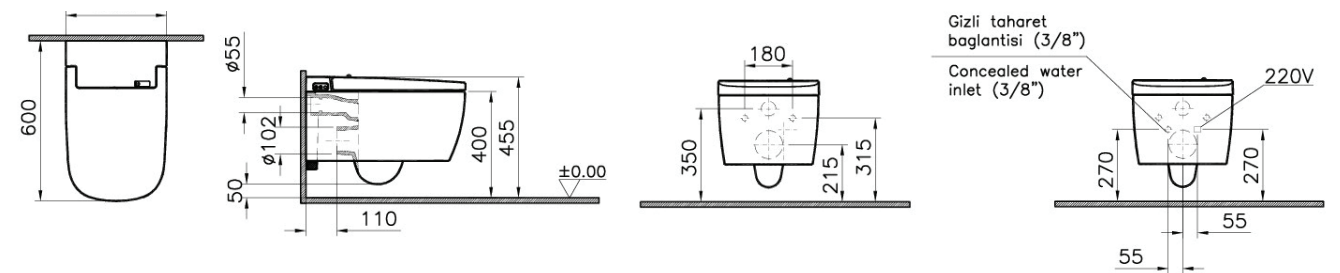



Flush plates

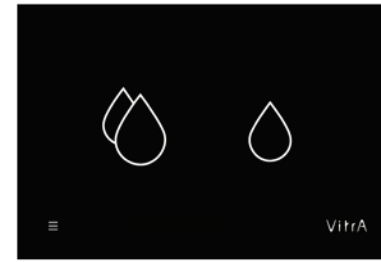

Smart Panel Electronic flush plate*

- Dual flush
- 1.5 kg
- Glass
- 768-1501 - Black
- 762-1501 - Black
- Compatible with:
- 768 flush plate to be used with 768 slim frame
- 762 flush plate to be used with regular 762 frame
- * Must be used with 300-1028

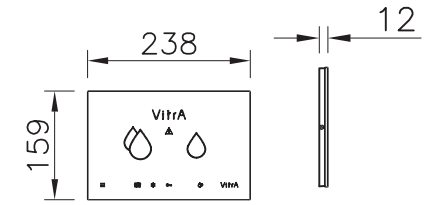

Pro-Touchless Electronic flush plate*

- Dual flush
- 0.5 kg
- Stainless Steel
- 768-1421 - Chrome
- 768-1440 - Brushed Chrome
- 768-1420 - Gold
- 762-1421 - Chrome
- 762-1440 - Brushed Chrome
- 762-1420 - Gold
- Compatible with:
- 768 flush plate to be used with 768 slim frame
- 762 flush plate to be used with regular 762 frame
- * Must be used with 300-1028

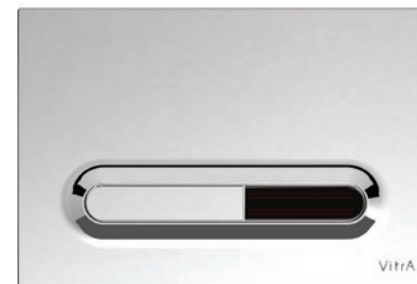
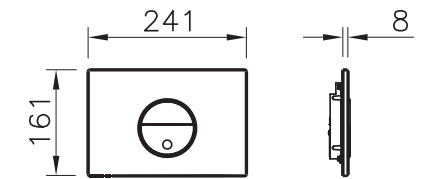

Loop T - Touchless Electronic flush plate*

- Dual flush
- 0.5 kg
- ABS Plastic
- 768-0880 - Chrome
- 768-0885 - Matt Chrome
- 762-0880 - Chrome
- 762-0885 - Matt Chrome
- Compatible with:
- 768 flush plate to be used with 768 slim frame
- 762 flush plate to be used with regular 762 frame
- * Must be used with 300-1028

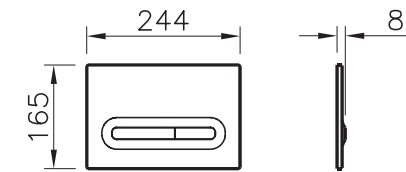

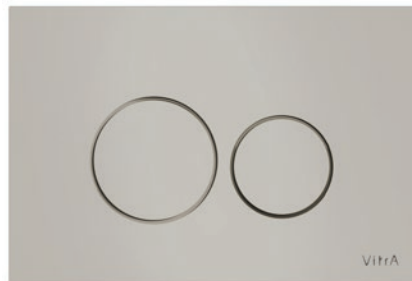

Origin
Mechanical flush plate

- Dual flush
- 0.5kg
- Glass
- 740-1600 - White
- 740-1601 - Black
- 740-1602 - Taupe
- 740-1603 - Mink
- Compatible with:
748-frames and 742-frames

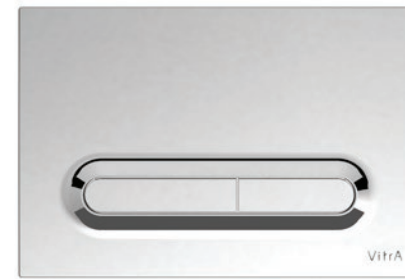
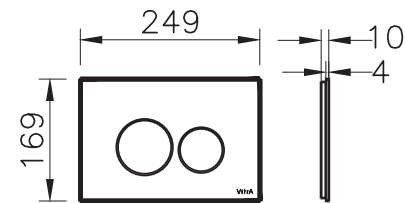

Loop T
Mechanical flush plate

- Dual flush
- 0.5kg
- ABS Plastic
- 740-1700 - Glass White
- 740-1711 - Matt Black
- 740-0780 - Chrome
- 740-0785 - Matt Chrome
- 740-0786 - Anti-fingerprint
- Compatible with:
748-frames and 742-frames

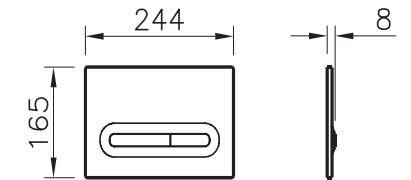

Loop O
Mechanical flush plate

- Dual flush
- 0.5kg
- ABS Plastic or Stainless Steel
- 740-0500 - Gloss White
- 740-0511 - Matt Black
- 740-0580 - Chrome
- 740-0585 - Matt Chrome
- 740-0586 - Anti-fingerprint
- 740-0940 - Stainless Steel
- Compatible with:
748-frames and 742-frames

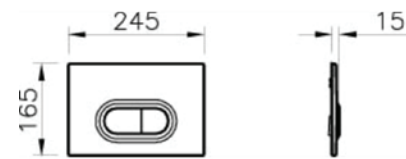

Electronic mechanism installation set
300-1028
Must be used with all electronic flush plates
Set must be installed during wall construction

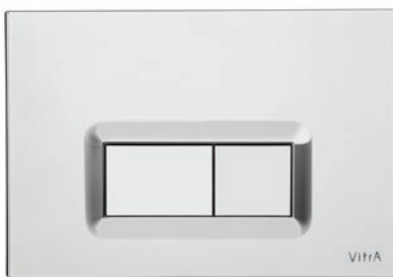

Loop R
Mechanical flush plate

- Dual flush
- 0.5kg
- ABS Plastic
- 740-0600 - Gloss White
- 740-0611 - Matt Black
- 740-0680 - Chrome
- 740-0685 - Matt Chrome
- 740-0686 - Anti-fingerprint
- Compatible with:
748-frames and 742-frames

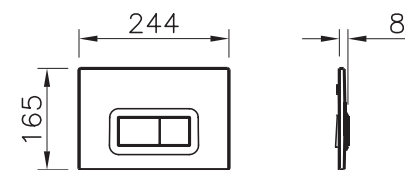



Frames and concealed cisterns



V-Fix Prime Concealed cistern for drywall& wall-hung WC pans, 12 cm thickness, 112 cm height / 762-5803-01

- Front operated
- Dual flush
- Min. wall mounting depth is 160 mm
- Includes junction box and cable channel for the connection of electronic products.
- Height adjustment can be done quickly and practically with spring feet.
- Possibility of mounting adapting to the drain structure with adjustable clamp

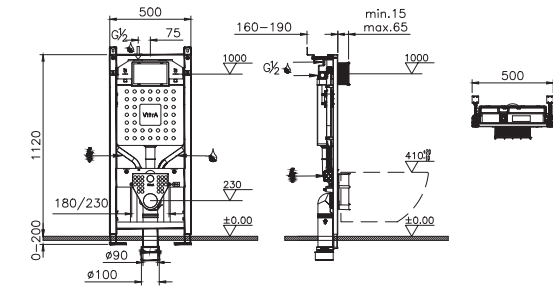

V-Fix Prime Concealed cistern for drywall& wall-hung WC pans, regular thickness, 98 cm height / 761-5823-01

- Front and top operated
- Dual flush
- Blow moulding reservoir
- water conduit pipe included for bidet-function WC's

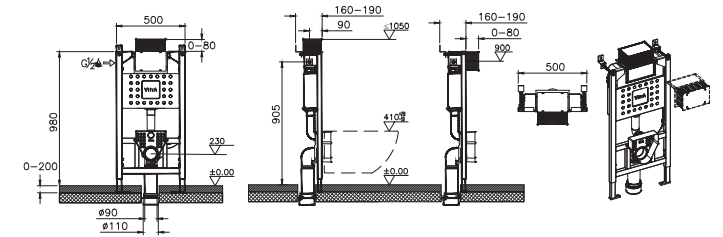

V-Fix Prime Concealed cistern for drywall& wall-hung WC pans, regular thickness, 82 cm height / 761-5803-01

- Front and top operated
- Dual flush
- Blow moulding reservoir
- water conduit pipe included for bidet-function WC's

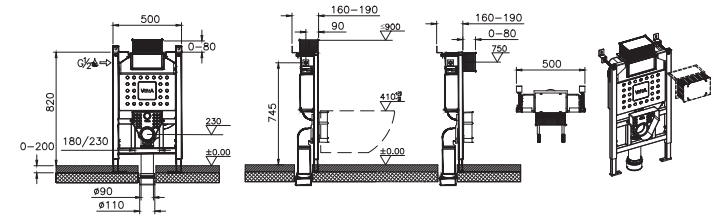

V-Fix Prime Concealed cistern for drywall& floor-standing&child WC pans, regular thickness, 98 cm height / 761-5833-01

- Front and top operated
- Dual flush
- Blow moulding reservoir
- water conduit pipe included for bidet-function WC's

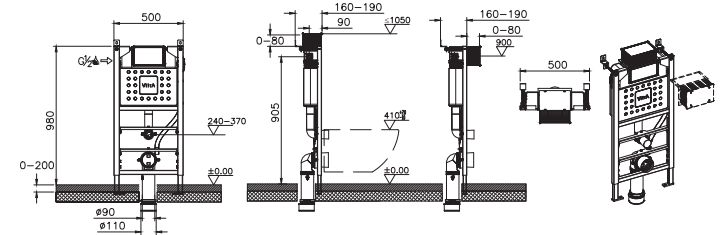



V-Fix Prime Concealed cistern for drywall & wall-hung WC pans, 12 cm thickness, 112 cm height / 762-4802-01 - 3/6 L

- Front operated
- Dual flush
- Min. wall mounting depth is 200 mm
- Drywall marking system
- Includes junction box and cable channel for the connection of electronic products
- Height adjustment can be done quickly and practically with spring feet.
- Possibility of mounting adapting to the drain structure with adjustable clamp



V-Fix Prime Concealed cistern for drywall & wall-hung WC pans, back to back cisterns, 112 cm height / 762-5850-01 - 3/6 L

- Dual flush
- Consisting of 2 concealed cisterns
- Min. wall mounting depth is 260 mm
- Drywall marking system
- Includes junction box and cable channel for the connection of electronic products.
- Height adjustment can be done quickly and practically with spring feet.
- Possibility of mounting adapting to the drain structure with adjustable clamp.

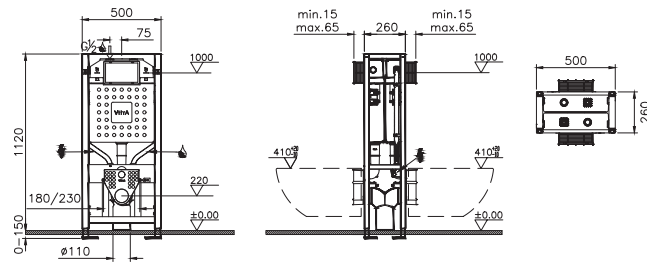

V-Fix Prime Concealed cistern for drywall & wall-hung WC pans, 8 cm thickness, 112 cm height / 768-5800-01 - 3/6 L

- Dual flush
- Min. wall mounting depth is 90 mm
- Drywall marking system
- Includes junction box and cable channel for the connection of electronic products.
- Height adjustment can be done quickly and practically with spring feet.
- Possibility of mounting adapting to the drain structure with adjustable clamp.
- For included water connection pipe version, 768-5800-XXEXP can be ordered with 30€ extra.
- 768-5800-XXEXP must be ordered with 300-1209 water connection flex.

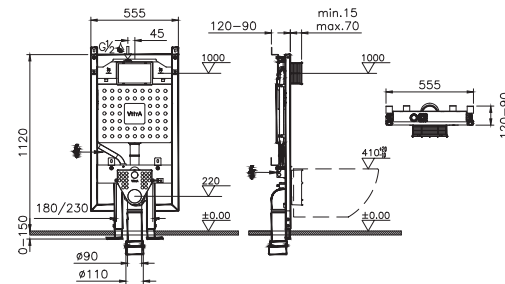

V-Fix Prime Concealed cistern for brick-wall & floor standing WC pans, 12 cm thickness, 112 cm height / 762-1735-01 - XX L

- Front operated
- Mechanic
- Dual flush
- Min. wall mounting depth is 120 mm

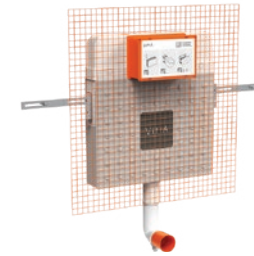

768-1740-01 - 3/6 L

- Suitable for back-to-wall WC pans and floor standing single WC pans.*
- Front operated
- Mechanic
- Dual flush
- Min. wall mounting depth is 80 mm

* For suitable installations, appropriate parts should be selected from 300-1202, 300-1203, 300-1204.

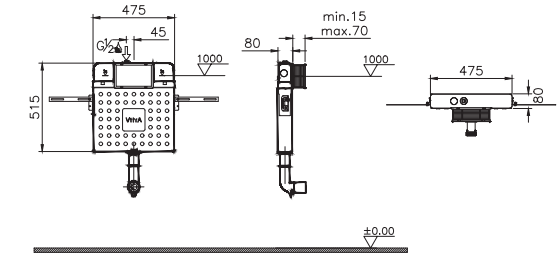

Renovation platform for wall-hung WC's, thin / 773-5760-01 - Light grey

- Suitable for wall-hung WC pans
- Suitable for pre-wall application
- 10,5 cm thickness
- Includes water extension pipes.
- V8 Vitra concealed cistern is included
- 300-1029 installation set is included.
- WC pan and touch free flush plate are not included.

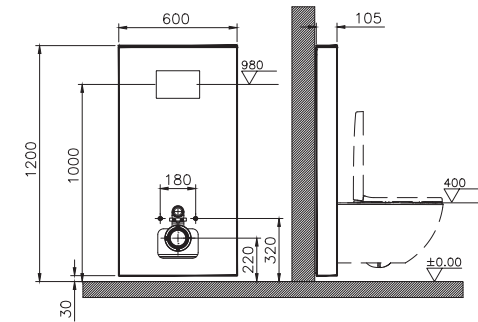

Renovation platform for wall-hung WC's, thin / 773-5761-01 - Black

- Suitable for wall-hung WC pans
- Suitable for pre-wall application
- 10,5 cm thickness
- Includes water extension pipes.
- V8 Vitra concealed cistern is included
- 300-1029 installation set is included.
- WC pan and touch free flush plate are not included.

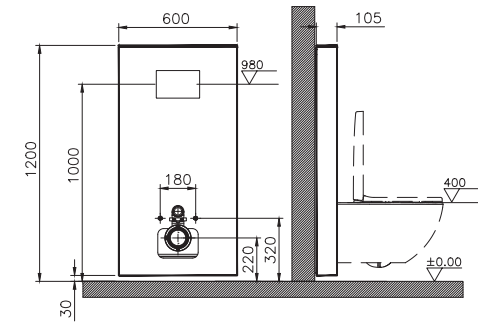

VitrA