

# 1 Important Safeguards

EN

## READ ALL INSTRUCTIONS BEFORE USING

### **DANGER - To reduce the risk of electric shock:**

1. Do not place or store this appliance where it can fall or be pulled into a tub or sink.
2. Do not place in, or drop into water or other liquid.
3. Do not reach for a product that has fallen into water. Unplug immediately.

### **WARNING - To reduce the risk of burns, electric shock, fire or injury to people:**

1. Close supervision is necessary when this appliance is used by or near children, elderly or invalid. Children should not be permitted to use or touch this appliance without the supervision of an adult. Be sure to adjust the temperature of the toilet seat for the elderly, those who are incapacitated or people with sensitive skins.
2. Use this appliance only for its intended purpose as described in this manual. Do not use attachments not recommended by the manufacturer.
3. Never operate this appliance if it has a damaged cord or plug, if it is not working properly, if it has been dropped, damaged or dropped into water.
4. Install this appliance properly according to this manual.
5. Only authorized people can install or repair this appliance. Do not attempt to repair this appliance by yourself, doing so could void the warranty.
6. Keep the cord away from heated surfaces.
7. Never drop or insert any object into any opening or hose.
8. Do not use outdoors. Do not use aerosol or oxygen spray products on the unit.
9. Always follow the grounding instruction in this manual before plugging in.
10. If the supply cord is damaged, it must be replaced by the manufacturer, its service agent or similarly qualified people in order to avoid a hazard.
11. This appliance is not intended for use by people (including children) with reduced physical, sensory or mental capabilities, or lack of experience and knowledge, unless they have been given supervision or instruction concerning the use of this appliance by a person responsible for their safety.
12. Children should be supervised to ensure that they do not play with this appliance.

## SAVE THESE INSTRUCTIONS

## 2 Cautions before installation

### NOTE THE FOLLOWING IMPORTANT POINTS

1. Do not install in location where water might be splashed on this appliance or in location exposed to such an excessive moisture that condensation forms on the product surface.
2. To avoid damage to electronic components due to high levels of humidity, provide adequate ventilation by opening a window and/or door when bathing. You may find operating an exhaust ventilating fan during these times of high humidity beneficial.
3. The new hose-set supplied with the appliance should be used and the old hose-set should not be reused.
4. Use a water supply having a water pressure 0.05 MPa ~ 0.75 MPa.
5. Connect the product to a pipe carrying potable water. Do not connect to an industrial water line or other water supply that does not carry water of drinking quality.
6. In areas where water freezes during winter make arrangements to keep the pipes warm. The water remaining in the unit may sometimes freeze during storage in winter. In that case, warm the unit in the room before installation.
7. The thermal protector in the water tank may sometimes trip during storage or transportation in warm weather causing non-operation. In that case, cool the unit in the room before installation.
8. The rated power voltage is 220~240 V / 50~60 Hz.
9. Do not supply electrical power to the unit until the plumbing installation work has been completed; it could cause malfunction.
10. Unplug the appliance during maintenance and cleaning.



### WARNING

**Before installing this product, always observe the local laws and regulations regarding installation**

In countries where power outlets are not permitted in bathrooms, such as U.K. or Ireland, please consult a qualified electrician for advice on connecting this unit to a power supply. The European two-pin plug should be removed and the unit should be connected to the mains by a qualified electrician.

In such countries, every time the operating instruction manual refers to unplug the power cord, the user must instead switch off the circuit.

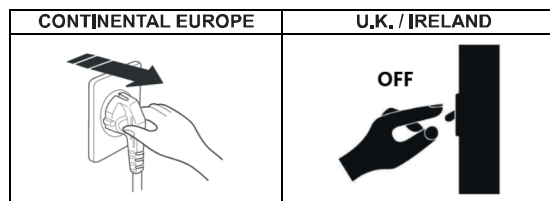

# 3 Identification

## 1. Main unit

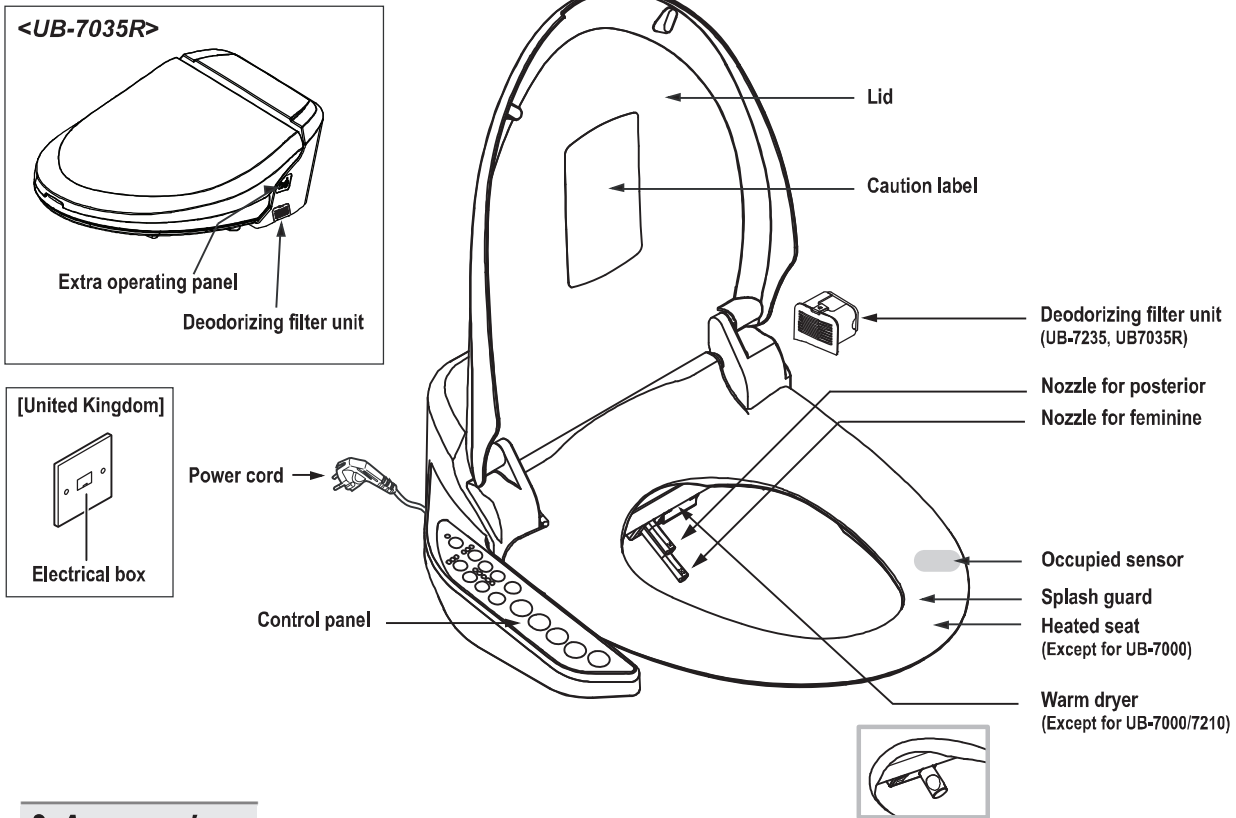

## 2. Accessories

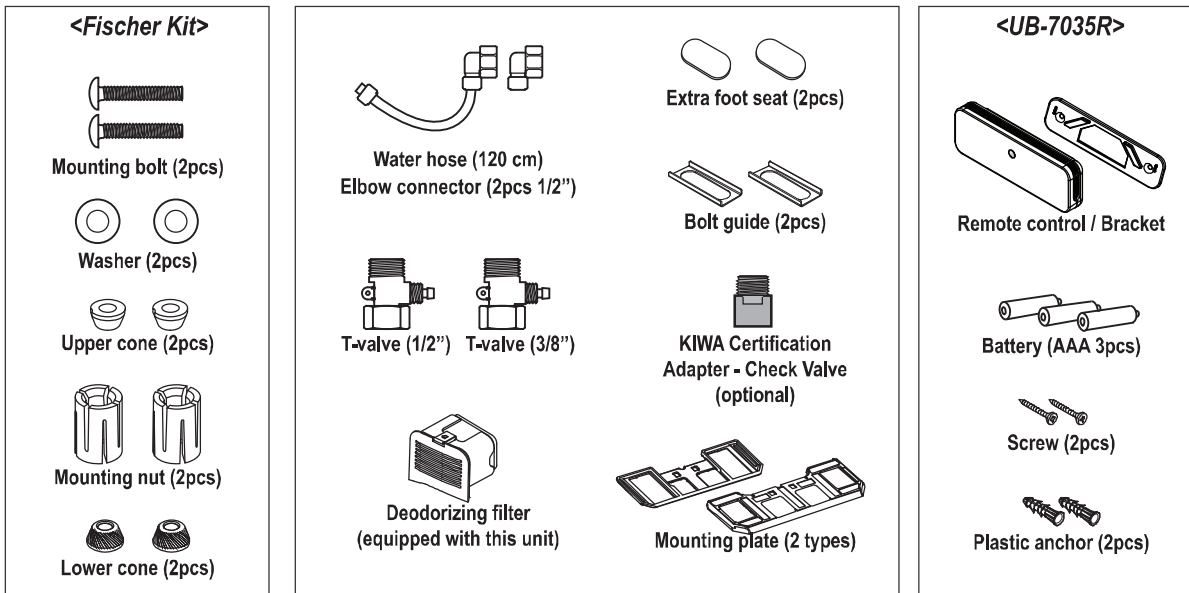

# 4 Safety Information (Danger)



## DANGER

Please follow basic instructions to ensure the safe use of your appliance

- Indicates a prohibited use of the appliance
- Indicates a required step in the use of this appliance

- Prohibited
- Do not handle with wet hands
- Do not throw any firearms
- Do not disassemble
- Do not wash
- Ground connection
- Required step



Meanings of symbols



PROHIBITED

### Do not use a faulty or loose electric outlet or cord

Doing so may result in a short circuit, electric shock or fire

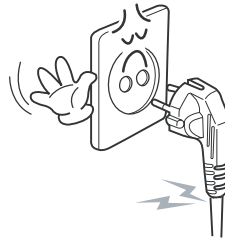

REQUIRED

### Do not obstruct the warm air dryer outlet

If the outlet is obstructed with any object, it may result in fire

If the outlet is obstructed with hands, it may result in injury



NO FIREARMS

### Do not throw anything flammable into the toilet

Doing so may result in fire



DO NOT WASH

### Do not wash this appliance with water

Doing so may result in fire or electric shock



GROUND CONNECTION

### Grounded wire or outlet must be installed

If avoided, it may result in short circuit or malfunction

If no grounded plug is used, make sure to install grounded wire





# DANGER

Please follow basic instructions to ensure the safe use of your appliance



PROHIBITED

## Do not use many appliances in a multiple adapter

Doing so may result in fire or damage

Be sure to use a dry and clean outlet

Do not use a faulty or loose outlet

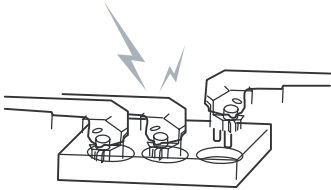

NO WET HANDS

## Plug and unplug properly

Do not plug or unplug with wet hands. It may result in injury or short circuit

Do not grab the cord when unplugging. Pull out the plug properly

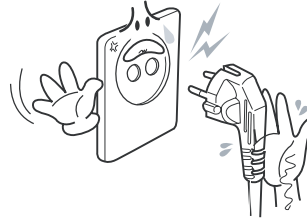

DO NOT DISASSEMBLE

## Do not use when the seat and lid are disassembled

Doing so may result in electric shock due to high voltage inside



REQUIRED

## Unplug when beeping or smelling strangely

Unplug right away

Contact your dealer where you bought this appliance



DO NOT DISASSEMBLE

## Do not disassemble, repair or modify this appliance

Doing so may result in fire or electric shock



PROHIBITED

## Use tap potable water only (ground water)

Not doing so may cause irritation or injury to your skin

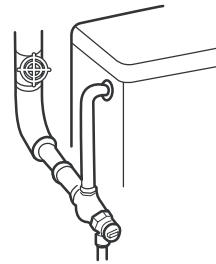

# 5 Safety information (Warning)



## WARNING

Please follow basic instructions to ensure the safe use of your appliance



PROHIBITED

### Do not step on or place heavy objects on this appliance

Doing so may damage the unit  
Do not step on a lid, seat or control panel to avoid injury or damage



REQUIRED

### Do not force the lid to close

Doing so may cause malfunction



REQUIRED

### Be aware of urine splash on a nozzle or warm air outlet

Not doing so may result in smelling of products or failure



PROHIBITED

### Do not sit or lean against the lid or control panel

Doing so may cause malfunction or breakage



REQUIRED

### Unplug while not using over extended period of time

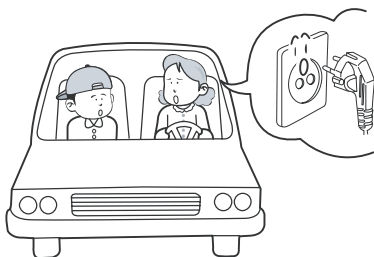

REQUIRED

### Unplug while there is a thunder or lightning

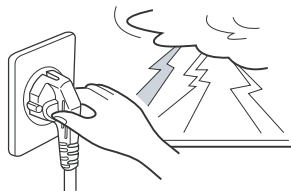



# WARNING

Please follow basic instructions  
to ensure the safe use of your appliance



PROHIBITED

## Do not pull out water hose forcefully

Doing so may cause water leakage

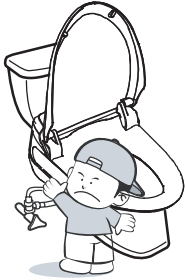

PROHIBITED

## Use this appliance on a toilet only

Not doing so may result in fire, injury  
or electric shock



**Improper use**



PROHIBITED

## Do not put a vase cup or small materials on this appliance



REQUIRED

## Be aware of a low-grade burn

It may result in a low-grade burn if sitting  
on the heated seat for a long time

Be aware if being used by the following:

- Children, elderly, patients, or who cannot control the grade of temperature
- Sleeping pills users, or people who are on medication that causes drowsiness
- Who are drunk or very tired and may fall asleep while sitting on the unit

If injured in a low-grade burn, see a doctor immediately



REQUIRED

## Unplug when cleaning

Not doing so may result in fire or electric shock

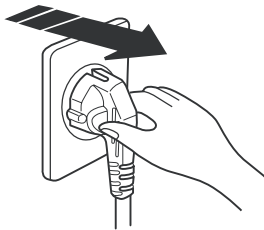

REQUIRED

## Use the low temperature for children and disabled

If high temperature is set up, it may result in  
burn due to not recognizing the temperature

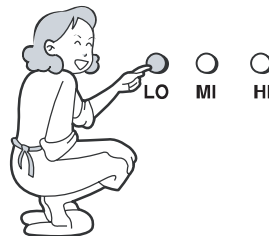

## 6 How to use UB-7235 / 7220 / 7215 / 7210 / 7000

### ※ Caution

All functions will be operational when the seat is occupied except Nozzle cleaning, Power/Economy.

Before operating, ensure that the water tank is filled up completely.

### Stop

- Press "Stop" to stop current operation.
- When a user stands up, all operations will stop automatically.

### Cleansing

- Press "Cleansing" to clean your posterior. The function will stop in 60 seconds automatically.
- Press this button again to activate oscillation. The nozzle moves back and forth automatically to widen cleansing area.
- Oscillation wash stops if this button is pressed again.

### Bidet

- Press "Bidet" for feminine wash. The function will stop in 60 seconds automatically.
- Press this button again to activate oscillation. The nozzle moves back and forth automatically to widen cleansing area.
- Oscillation wash stops if this button is pressed again.

### Dry (warm air) (UB-7235 / 7220 / 7215)

- Press "Dry" button. The dryer nozzle comes out (level 3, position 3). This function will stop in 180 seconds automatically.
- Press this button again to switch between Soft and Turbo drying modes.

### IIP (intensive impulse pulsation) (UB-7235 / 7220 / 7210)

- Intensive water pulsation (water pressure level 5) may help you for easier defecation. This function will stop in 60 seconds automatically.

### Kids / Auto (UB-7235 / 7220 / 7210)

- Press "Kids/Auto" to change all functions to be suitable for children. The following settings will be selected:
  - Posterior nozzle in oscillating mode: 1 min (pressure level 1, position 5).
  - Drying: 3 mins.Children should use this unit under adult supervision.
- Press "Kids/Auto" twice to activate Automatic function. The following settings will be selected:
  - Feminine nozzle: Wash - Oscillation - Pulsation will operate consecutively for 1 min (pressure level 3, position 3).
  - Drying: 3 mins (level 3, position 3).

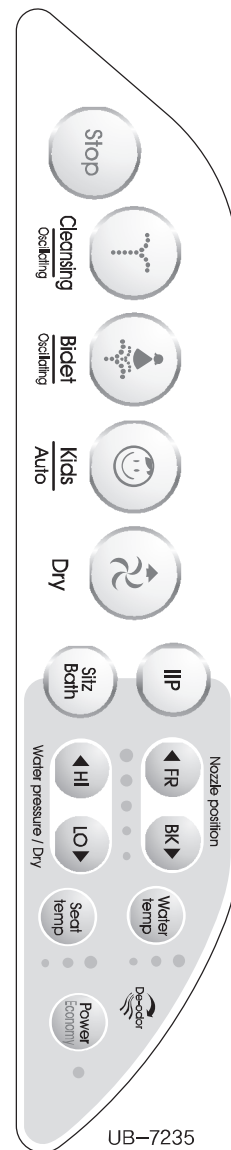

### Self-diagnosis system

- This appliance has a self-diagnosis system.
- If the appliance experiences a problem, a power LED will blink.

※ When the power is plugged in initially, nozzles for feminine and posterior wash will come out in turn.



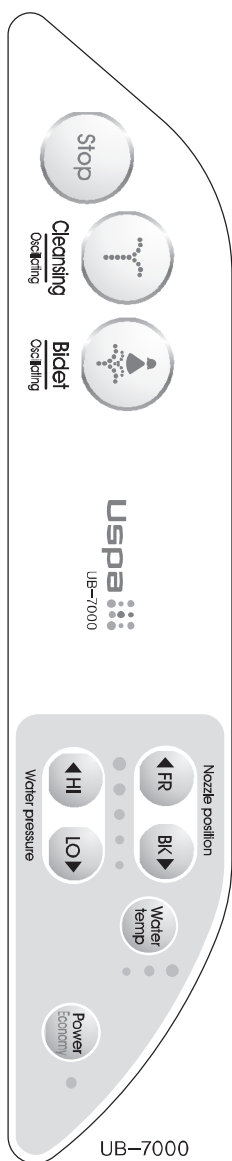

UB-7000

- Unplug and contact customer center immediately.

### **Sitz Bath (Healthy Wash) (UB-7235 / 7220 / 7215)**

- Press this button to activate soft and warm water spray (nozzle position 3, water pressure level 2, water temperature 3) for washing and massaging.
- Feminine nozzle will operate 3 minutes and will stop automatically.
- Press this button again during this function to switch between normal washing and washing with oscillation.

### **Automatic deodorization (UB-7235)**

- When the appliance is in use, the deodorizer will work automatically (max 20 minutes).
- When a user stands up, it stops after 60 seconds.

### **Nozzle position**

- Nozzle position can be adjustable by pressing the nozzle position button.
- Position will be initialized (level 3) after each use.

### **Water pressure / Dry (UB-7235 / 7220 / 7215)**

- Water spray pressure can be adjusted in 5 levels.
- Dryer temperature can be adjusted in 5 levels.
- Both levels will be initialized (level 3) after each use.

### **Temperature adjustment (water / seat)**

- Temperature of water and seat (except UB-7000) can be adjusted.
- There are four levels, Room temp-Low-Medium-High.

### **Power / Economy**

- Press the button to select Power on/off or Economy mode.
- In the Economy mode, temperature of the seat will be kept to 30 °C.
- When the unit is occupied during the Economy mode, the temperature will be returned to the original setting and goes back to the Economy mode after each use.
  - Red light: Normal mode.
  - Green light: Economy mode.
  - Off: Power off.

### **Self cleaning**

- This appliance automatically cleans its nozzles before and after every use.

※ All the operating times indicated are approximate.

## 6 How to use UB-7035R

- ⊗ When the power is plugged in initially, nozzles for feminine wash and posterior will come out in turn.
- ⊗ All the operating times indicated are approximate.

### Cleansing

- Press "Cleansing" to clean your posterior. The function will stop in 60 seconds automatically.
- Cleansing function can be activated in 3 modes:  
Press the button 1st time: Normal cleansing.  
2nd time: Cleansing with oscillation to widen cleansing area.  
3rd time: Cleansing with oscillation and pulsation.  
4th time: Normal cleansing again.

### Bidet

- Press "Bidet" for feminine wash. The function will stop in 60 seconds automatically.
- Bidet function can be activated in 3 modes:  
Press the button 1st time: Normal washing.  
2nd time: Washing with oscillation.  
3rd time: Washing with oscillation and pulsation.  
4th time: Normal washing again.

### Kids

- Press "Kids/Auto" to change all functions to be suitable for children. The following settings will be selected:
  - Oscillation: 1 min
  - Drying: 3 mins.
  - Water pressure level 1
  - Nozzle position level 5
- Press this button again to activate different modes:  
Cleansing with oscillation, Cleansing with oscillation and pulsation, Normal cleansing.
- Children should use this unit under adult supervision.

### Auto

- Press "Kids/Auto" button twice within one second to activate the automatic function. The following settings will be selected:
- Normal cleansing (20 sec), Cleansing with oscillation (20 sec), Drying (3 min).  
Stop function will operate consecutively.

### Dry (warm air)

- Press "Dry" button. The dryer nozzle comes out and drying function will operate during 3 min.
- Press this button again to switch between Soft and Turbo drying modes.

### Stop

- Press "Stop" to stop current operation.
- When a user stands up, all operations will stop automatically.

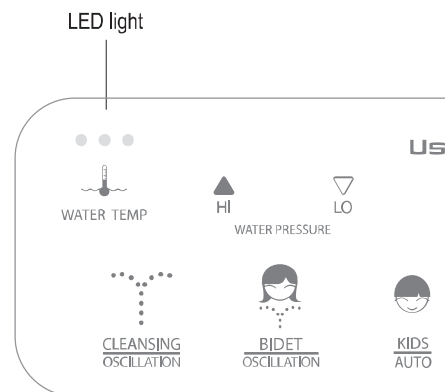

### Side control buttons

- Use side control buttons on the unit when the remote control is broken or the charge of batteries is low.
- While seated, press "Cleansing" on the right side or "Bidet" on the left side to start.

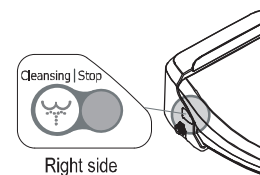

### Power / Economy

- Press "Bidet" on the left side panel to select Power on/off or Economy mode.
- In the Economy mode, temperature of the seat will be kept to 30 °C.

### Self-diagnosis system

- This appliance has a self-diagnosis system.
- If the appliance experiences a problem, the power LED will blink.

### Self cleaning

- This appliance automatically cleans its nozzles before and after every use (see p. 12).

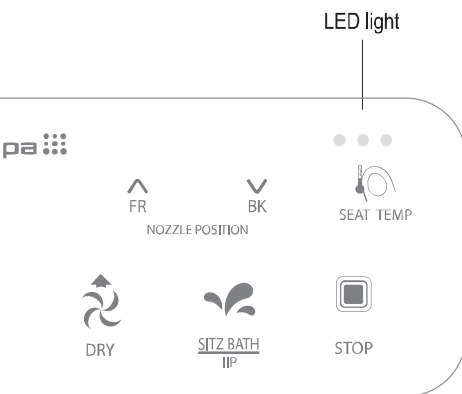

Press again to stop. Do not use sharp items to press buttons.

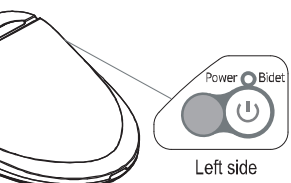

- When the unit is occupied during the Economy mode, the temperature of the water and seat will be returned to the original setting and go back to the Economy mode after each use.
  - Red light: Normal mode.
  - Green light: Economy mode.
  - Off: Power off.

- Unplug and contact customer center immediately.

### Sitz Bath (Healthy Wash)

- Press this button to activate soft and warm water spray (water temperature level 3, water pressure level 1) for washing and massaging.
- Feminine nozzle will operate 3 minutes and will stop automatically.
- Press this button again during this function to switch between normal washing and washing with oscillation.

### IIP (Intensive Impulse Pulsation)

- Press "SITZ BATH/IIP" twice within one second to activate IIP function to have easy defecation. It works for 60 seconds and stops automatically.
- Press "IIP" button again to change the frequency of the pulsation mode (3 different modes available). Initially water pressure is set to level 5.

### Water temperature adjustment

- Press the button to adjust water temperature to Room temp-Low-Mid-High.
- LED lamp will indicate the level:
 

Room temp: LED is off	Low temp: 1 LED is on
Mid temp: 2 LED is on	High temp: 3 LED is on

### Water pressure

- Water spray pressure is adjustable to the desired pressure by pressing button from 1 to 5 when being used.
- During drying function it will adjust air flow temperature.
- Both levels will be initialized (level 3) after each use.

### Nozzle position

- Nozzle position is adjustable by pressing button from 1 to 5 positions when being used. Position will be initialized (level 3) after each use.

### Seat temperature adjustment

- Press the button to adjust seat temperature to Room temp-Low-Mid-High.
- LED lamp will indicate the level:
 

Room temp: LED is off	Low temp: 1 LED is on
Mid temp: 2 LED is on	High temp: 3 LED is on

### Automatic deodorization (max 20 minutes)

- When the appliance is in use, the deodorizer will work automatically.
- When a user stands up, it stops after 60 seconds.

### ※ Caution

- Be aware of not dropping the remote control in water. It may cause malfunction.  
 All functions will be operational when the seat is occupied except  
 Nozzle cleaning, Power/Economy.  
 Before operating, ensure that the water tank is filled up completely.

# 7 How to clean

EN

## Nozzle cleaning

**Caution** Do not forcefully push or pull the nozzles, or bend them. It may result in failure. Make sure to use "Cleaning" button on the remote control.

Make sure the occupied sensor is not activated (not sitting on the seat or not place hands on the seat sensor part).

### UB-7235 / 7220 / 7215 / 7210 / 7000

Press "FR" button, posterior nozzle comes out.  
Press "BK" button, feminine nozzle comes out.  
Press "Stop", "FR", "BK" and nozzles will return to their stand-by mode.

### UB-7035R

Press "FR" button for 3 seconds, feminine nozzle comes out.  
Press "FR", "BK" to shift alternatively the nozzles.  
Press "Stop", nozzles will return to their stand-by mode.  
Press "BK" button for 3 seconds, feminine and posterior nozzles come out alternatively for five times each, activating self nozzle cleaning program.  
Do not forcefully push or pull the nozzles, or bend them.  
Use a toothbrush or soft cloth to clean nozzles.  
For extended period of time cleaning, unplug for safety.  
Do not retract nozzles without a nozzle tip. It may result in malfunction.  
Beware of losing or switching nozzle tips.

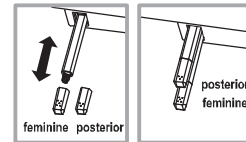
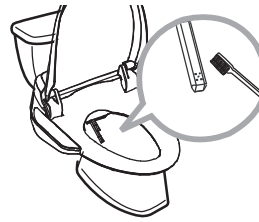

## Strainer maintenance

This appliance will not operate properly if the strainer is clogged. Be sure to clean the strainer regularly.

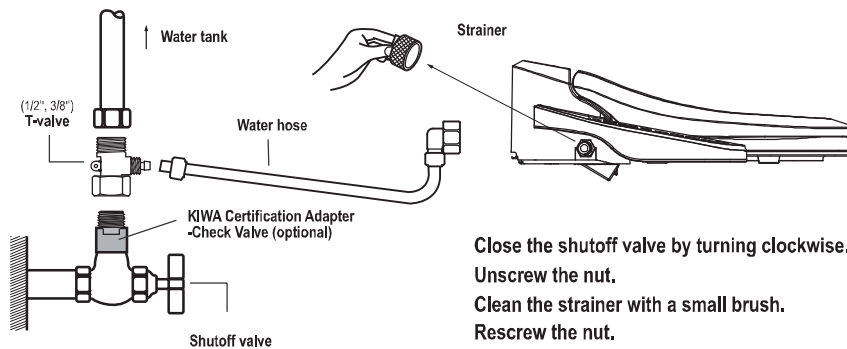

Close the shutoff valve by turning clockwise.  
Unscrew the nut.  
Clean the strainer with a small brush.  
Rescrew the nut.  
Open the shutoff valve by turning counter clockwise.

## Cleaning the body

Regularly wipe off the body with a dry soft or sponge, or dampen with neutral detergent.

Release the lid.

1. Pull left and up the left hinge part.
2. Release the right hinge part (be aware your fingers not to be caught).

For care of plastic body, do not use any cleansers which are not safe to use on toilet seats (toilet cleanser, home cleanser, bleach, benzene, paint thinner, cresol etc.).

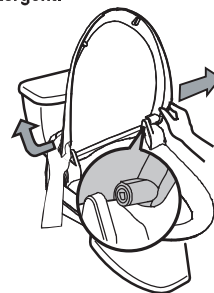

## Draining water - while not using over extended period of time

**Unplug the power supply cord.**

Not doing so may cause fire.

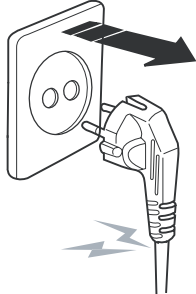

**Detach the unit.**

Refer to the installation method.



**Close the shutoff valve.**

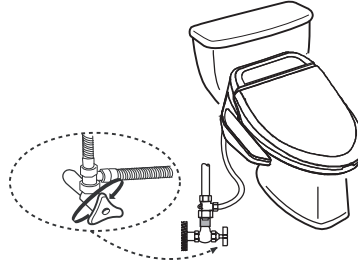

**Uphold the appliance and thoroughly drain the water by unscrewing the drain bolt (beware of losing the drain bolt).**

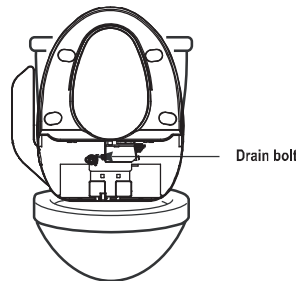

**Screw the drain bolt and install the appliance.**

Refer to the trial operation method in order to use this appliance again.

## Preventing freezing

**Make sure the power cord is plugged in properly.**

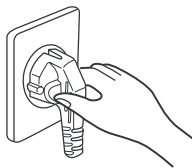

**Set the temperature of water to low or middle. (Freezing can be prevented by thermal efficiency of water tank).**

If there is no heating system in the toilet, wrap pipes with cloth or other materials.

**Not using the unit for a long time in winter unplug and drain the water from the water tank and pipes thoroughly.**

Refer to the water drain method.

# 9 How to install



Do not plug in until installation is finished completely.  
Not doing so may damage the appliance.

If electric work is needed, contact a qualified electrician or serviceman only.

## Remove the existing toilet lid and seat

1. Remove the nuts, washers and cone packings from the toilet seat mounting bolts in the back of the toilet
2. Remove the toilet seat, lid and mounting bolts.
3. Keep them in case of installing again.

## Install the appliance

### Installation

#### How to mount the plate

Place the plate and guides over each mounting hole. Insert the mounting bolts respecting the sequence shown in the picture.

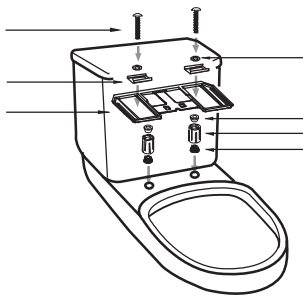

Mounting plate    Bolt guide    Mounting bolt  
Washer    Upper cone    Mounting nut    Lower cone

#### How to attach and detach the unit



Slide the unit until it clicks into plate.



Lift the unit up and forward.

### Toilet size

The toilet dimensions must be within those shown below. Do not install this appliance on a toilet that does not meet those dimensional requirements.

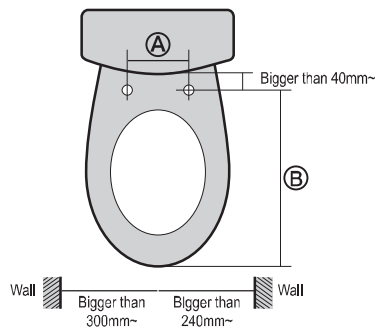

(UNIT: mm)

MODEL	A	B
Comfort	140 ~ 240	430 ~ 480
Standard	140 ~ 240	400 ~ 450
Design	140 ~ 240	410 ~ 460

### Occupied sensor

This appliance is equipped with occupied sensor. Unit will not work unless seat is occupied.

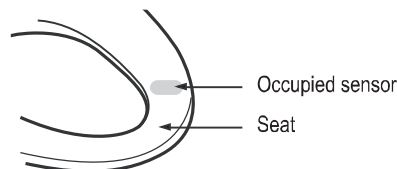

## Connecting the water hose and grounding wire

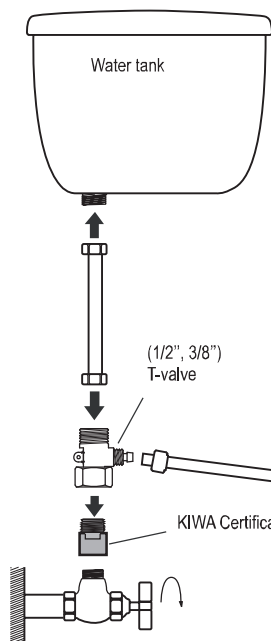

Close the shutoff valve by turning clockwise.

Flush the water tank completely to empty.

Disconnect the existing water supply hose from the shutoff valve.

If required, connect the KIWA Certification Adapter Check Valve as shown on the picture.

Install the T-valve as shown on the picture.

Connect the existing water supply hose from the tank to the T-valve.

Connect the new flexible hose from the T-valve to the main appliance.

Open the shutoff valve by turning counter clockwise.

☑ Check for any water leaking or dripping.

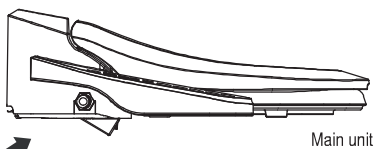

※ If the flexible hose is too long, it can be cut easily to the required length.

## Trial operation

### 1. Preparation

Plug the power cord into the outlet. Press "BIDET" or "CLEANSING", then water tank will be filled. Within 30 seconds after the water tank has filled up, you will hear a long buzzer sound.

### 2. Checking all functions

Cover the toilet bowl using the plastic wrapping sheet of the unit to prevent water from being sprayed out of the toilet. Then check for all the functions described in this manual.

### 3. During trial operation there are possibilities of remaining water coming out from the unit while heating.

## Remote control unit

### How to insert batteries

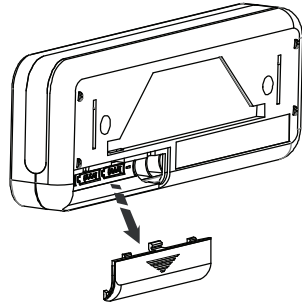

1. Open the battery lid of the remote control and insert 3 AAA batteries into the battery compartment.
2. Check if the remote control works properly while the seat is being occupied.

- Use 3 AAA batteries only. Do not use rechargeable batteries.
- Do not use old and new batteries together. Use same type of batteries only.
- Make sure that all batteries are inserted correctly.
- Remove the batteries if the remote control is not used for a long time.

### How to attach the remote control bracket to the wall

- Use screw with the plastic anchors or attach the bracket with the sticker.

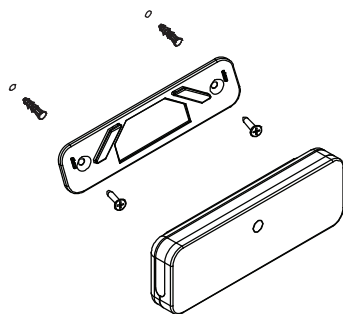



## 10 Before calling for service

Problem	Possible cause	Solution
Completely fail to work	Is there a power cord outage? Is the power cord unplugged? Are you sitting on the seat correctly?	Check for a power cord failure or a tripped breaker Plug the power cord properly Sit on the seat completely
Water does not spray	Is the water shutoff valve closed? Is the strainer clogged? Are the nozzles clogged?	Open the shutoff valve Clean the strainer Clean the nozzles
Water is leaking or dripping	Check if all hoses are tightened properly	If water is still leaking or dripping, contact your dealer
Seat, water or air is not enough warm	Is the temperature set to OFF? Is the appliance used in economy mode during a cold weather?	Reset the temperature Release the economy function

NE

## 11 Specifications

Item	UB-7035R	UB-7235	UB-7220	UB-7215	UB-7210	UB-7000
Standard power supply	220~240V / 50~60Hz 1660~1975W					220~240V / 50~60Hz 1605~1910W
Water supply	Way of connection	Direct connection to tap water				
	Water pressure	0.05MPa~0.75MPa				
Cleansing	Spray for cleansing	650 ± (100)mL / min				
	Spray for bidet	650 ± (100)mL / min				
	Water capacity	200 mL				
	Spray temperature	Room temp ~40 °C (104 °F)				
	Heat capacity	220~240V / 1600W~1900W				
	Safety feature	Thermal switch, temperature fuse, Floating switch				
	Dry	Air temperature	Room temp ~60 °C (140 °F)			None
Heater capacity		220~240V / 280~333W			None	
Safety feature		Temperature fuse			None	
Heated seat	Seat temperature	Room temp ~40 °C (104 °F)				None
	Heater capacity	220~240V / 55~65W				None
	Safety feature	Temperature fuse				None
Deodorization method	Catalytic filter		None			
Circuit breaker	Within 15mA 0.03 second					
Length of power cord	1.5m					
Dimensions	Comfort	(W)392x(L)520x(H)157mm	(W)466X(L)520X(H)157mm			
	Standard	(W)392x(L)490x(H)157mm	(W)466X(L)490X(H)157mm			
	Design	(W)392x(L)504x(H)157mm	(W)466X(L)504X(H)157mm			
Weight	4.2Kg	4.4Kg			4.2Kg	

# WARRANTY

## USPA Personal Hygiene Appliance Limited Warranty

We warrant our products to be free from manufacturing defects under normal use and service for a period of two (2) years from date of your purchase. Only the ORIGINAL PURCHASER may make a claim under this limited warranty.

Our obligation to you under this warranty is limited to repair or replacement, at our option, of defective products or parts, provided that the products were properly installed and used in accordance with instructions. We reserve the right to make inspections in order to determine the cause of the defect. We will not charge for labor or parts in connection with warranty repairs or replacement. We are not responsible for the cost of removal, return and/or reinstallation of products.

This limited warranty does not apply to:

- a) Damage or loss from fire, earthquake, flood, storm, etc.
- b) Damage or loss resulting from any unreasonable use, abuse, negligence or improper maintenance.
- c) Damage or loss from improper installation, removal, repair, or modification.
- d) Damage or loss resulting from sediment or other matters contained in your water system.

This warranty gives you specific legal rights.

For warranty or service information, please contact your dealer where you bought this appliance or please contact us.

Only the original purchaser may submit a claim under this limited warranty. To activate your warranty, complete this form.

This limited warranty is our only warranty covering your product. Repair or replacement as provided under this warranty shall be the exclusive remedy available to you. We shall not be responsible for loss of the product or for other incidental, or consequential damage or expenses you may incur or for labor or other costs due to installation or removal or cost or repairs by others, or for any other expense not specifically stated above. Except to the extent prohibited by appliance law, any implied warranties, including that of merchantability or fitness for use are expressly limited to the duration of this warranty.

※ Warning! We are not responsible or liable for any failure of or damage to this plumbing product component caused by in-tank bowl cleaners containing chlorine (calcium hypochlorite).

※ Note: the use of high concentration of chlorine related products can seriously damage the fittings. This damage can cause leakage and serious property damage.

For more information, please contact your dealer or us.

Purchase Date \_\_\_\_\_ Purchase Form \_\_\_\_\_

Invoice# \_\_\_\_\_ Amount Paid \_\_\_\_\_ Serial# \_\_\_\_\_

Address \_\_\_\_\_ City \_\_\_\_\_ Country \_\_\_\_\_ Zip \_\_\_\_\_

Phone \_\_\_\_\_ Fax \_\_\_\_\_ E-Mail \_\_\_\_\_

Mail, email or fax the warranty form to:

### USPA EUROPE S.R.L.

VIA MONTEVERDI, 8 - 28100 NOVARA - ITALY

TEL : +39 0321 030449 FAX : +39 0321 031648

<http://www.uspa.eu>

[info@uspa.eu](mailto:info@uspa.eu)

*Great products for your healthy living!*