

ver.1312

dib

[www.lsdaewon.co.kr](http://www.lsdaewon.co.kr)

**LS Daewon**  
LIVING SOLUTION

Head Office&Factory  
94, Robot land-ro 249beon-gil, Seo-gu,  
Incheon, Korea

**LS Daewon**  
LIVING SOLUTION

dib

LIFE STYLE DESIGNER

## User's Guide

This user's guide contains the product warranty certificate.

Be sure to read this user's guide carefully before use.

220V ~ 240V, 50Hz 

[www.lsdaewon.co.kr](http://www.lsdaewon.co.kr)

**DIB-C700 Series**

DIB-C750/C730



dib...

**THIS UNIT WAS MANUFACTURED FOR HOUSEHOLD USE ONLY.  
READ ALL OPERATING INSTRUCTIONS BEFORE INSTALLATION.**

**Notes**

1. This product should be installed according to this manual.
2. Please read this manual carefully and install properly.
3. Please save this manual and place it at an easily accessible place.
4. Do not attempt to service this appliance yourself. Doing so could void warranty.

# CONTENTS

|                                        |    |
|----------------------------------------|----|
| 1. Safety Instructions .....           | 4  |
| 2. Product Characteristics .....       | 8  |
| 3. Designation of Each-Component ..... | 9  |
|                                        |    |
| 4. Installation .....                  | 11 |
| 5. Trial Operation .....               | 13 |
| 6. Disassembly of Product .....        | 14 |
|                                        |    |
| 7. How to Use the Product .....        | 16 |
| 8. User Settings .....                 | 20 |
|                                        |    |
| 9. Maintenance & Cleaning .....        | 22 |
| 10. Before requesting repair .....     | 24 |
| 11. Product Specifications .....       | 25 |
| 12. Comparison Chart .....             | 26 |
| 13. Memo .....                         | 27 |
| 14. Warranty Information .....         | 31 |

Preparation

Installation

Operation

Maintenance  
& Cleaning

# 01. Safety Instruction

● Each symbol refers to the followings:

 **Warning** Risk of hazardous or lethal damage when violating the instructions.

 **Caution** Risk of injury or material damage when violating the instructions.

● Each pictorial indication means the followings:

 means prohibition

 Disassembly is not allowed

 Don't touch with wet hand

 Use of fire prohibited

 Don't spray water

 General prohibition

 means obligation

 Obligatory Instruction

 Grounding Connection

## Warning

Disassembly, modification or repair is not allowed.

▶ Risk of electric shock or fire.



Don't plug or touch the power cord with wet hands.

▶ Risk of electric shock.

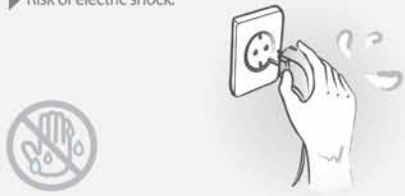

Don't spray water on the main body of product or power plug.

▶ Risk of electric shock or fire.

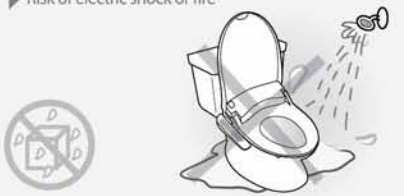

Don't use the damaged power cord or outlet.

▶ Risk of electric shock or fire.

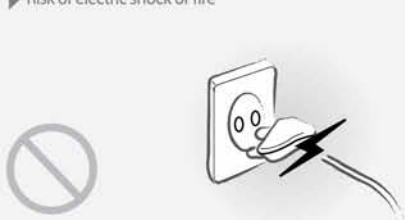

## Warning

Don't fail to do grounding.

- ▶ Always use the outlet that encloses the earth electrode. (Earth terminal mounting outlet-check if there is earth or not).
- ▶ In case there is no earth electrode, do grounding separately.
- ▶ When it is not grounded, it causes the failure and electric shock.



Insert the power plug correctly in 220~240V exclusive outlet.

▶ Risk of heat or fire.



Don't locate the cigarette or flammable materials near the product; Don't throw the cigarette into the product.



Don't connect the product to the water pipe of industrial use.

▶ Risk of causing dermatitis of user.

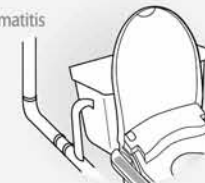

Don't connect power to the product before its complete installation on the toilet.



When the power cord or plug is damaged, always inform the service center, and replace if required.



Don't block the hot air hole nor put any object or hand on the hole.

▶ Risk of burn or electric shock. (DIB-1300, 1500 only)

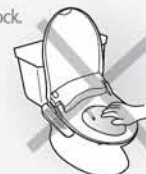

When removing the product from toilet, always release the power plug first.

▶ Risk of electric shock.



# 01. Safety Instruction

## ⚠ Caution

Don't stand on the product ; don't put heavy object on it.

▶ Risk of injury or damage to the product.

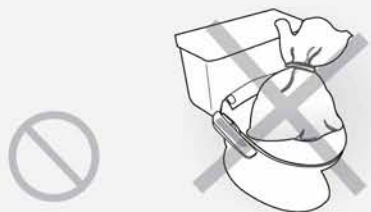

Don't force to close the cover of toilet.

▶ Risk of failure.

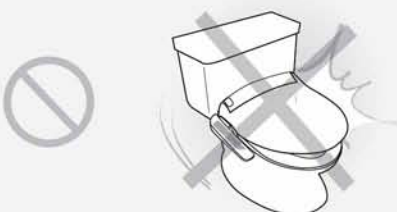

Don't force to lean against the cover of toilet.

▶ Risk of failure.



When cleaning, don't use toilet-use detergent, benzene, thinner, etc.

▶ Risk of damage to the product or crack.

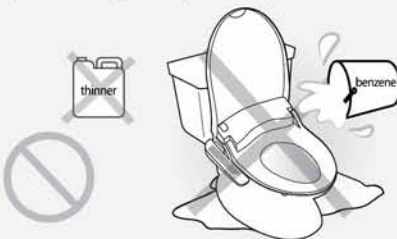

Don't bend the connecting hose ; don't force to pull it out.

▶ It may cause stoppage of water supply or leakage.

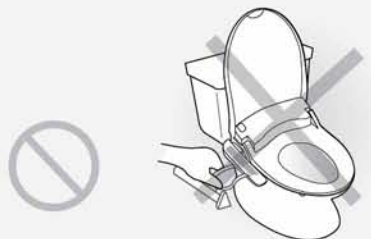

Be cautious low temperature burn.

▶ When the skin has been in contact with a seat for a long time, it may cause low temperature burn. The seat temperature should be set on Low or off when the unit is used for children, elderly persons, persons who cannot control the temperature by themselves.



## ⚠ Caution

When the product is not used an extended period of time, remove the power plug and drain the water out of the product tank.

▶ It may cause the water rotten and result the skin disease.

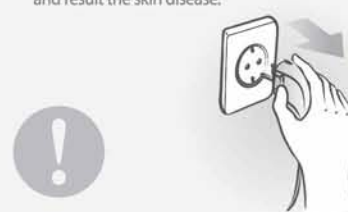

Don't use with the product out of order.

▶ When it is out of order, remove the plug from the outlet and inform the service center.  
▶ Otherwise, it may cause fire or electric shock.



When installing, push it in until it sounds 'Click'.

▶ It may cause water leakage or mal-operation.



Don't place the removed product upside down.

▶ Risk of the product failure.

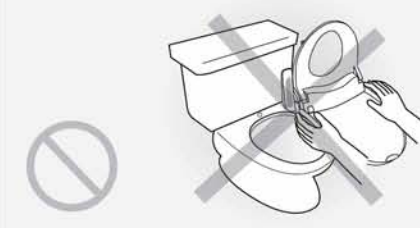

dib

## 02. Product Characteristics

dib bidet has the following characteristics:

### ● Continuous Warm Water Supply

Enjoy continuous warm water throughout the wash cycle.



### ● Power wash

Soft but powerful water wash for added cleansing benefit.



### ● Bubble Wash

Aerated water wash adds cleaning comfort.



### ● Stainless steel nozzle

For better hygiene, a stainless steel nozzle is applied.



### ● Pulse & Massage

Pulsating wash repeatedly cycles from weak to strong. Nozzle moves back and forth for massage effect.



### ● Deodorization Function (DIB-C750 only)

Semi-fundamental deodorizing filter provides odor-free during use.



### ● Energy Saving Function

It finds out the time frame when used frequently, realizing the maximum energy saving effect.



### ● Child Settings

Specialized nozzle position and water pressure for children.



## 03. Designation of Each Component

### Main Body

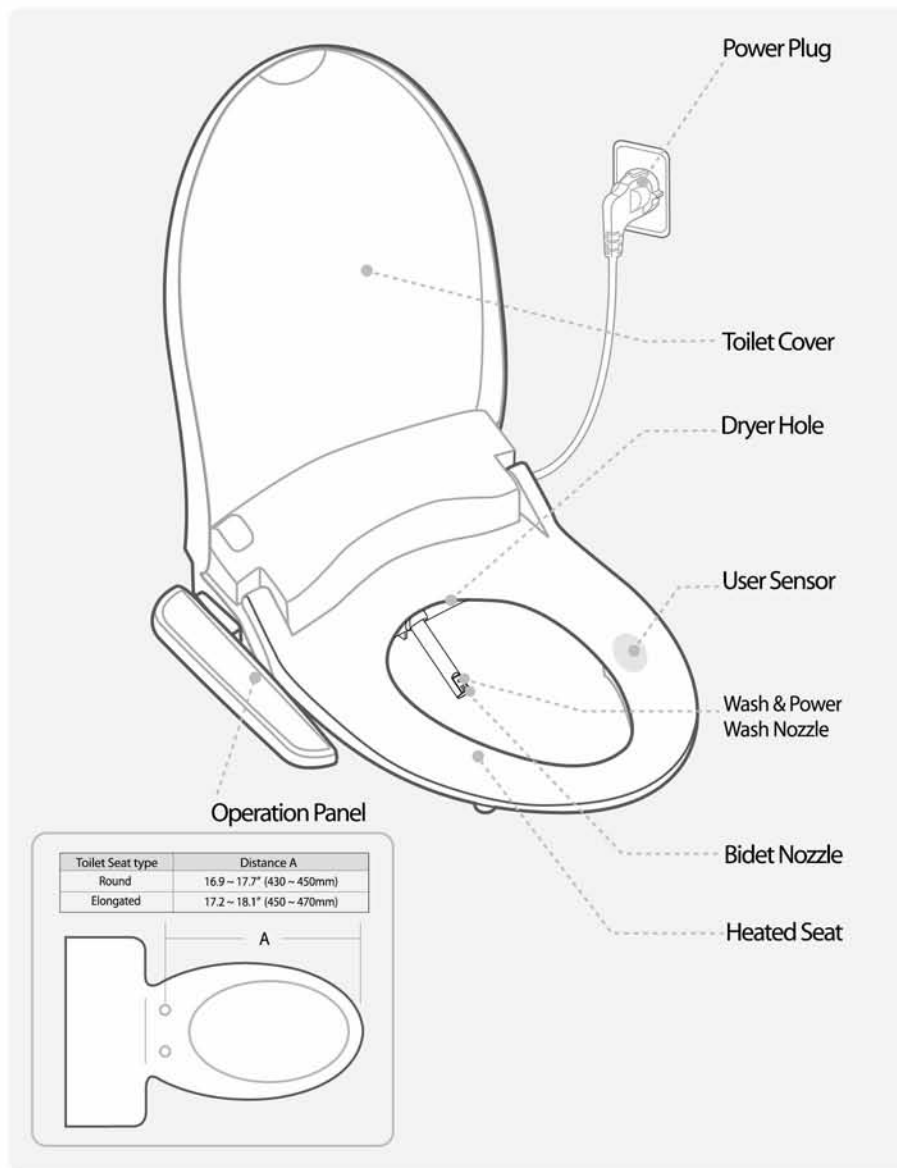

| Toilet Seat type | Distance A                 |
|------------------|----------------------------|
| Round            | 16.9 - 17.7" (430 - 450mm) |
| Elongated        | 17.2 - 18.1" (450 - 470mm) |

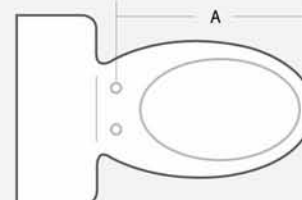

# 03. Designation of Each Component

## Operation Panel

**STOP**  
To stop all functions

**BIDET**  
To run the bidet function (2 minutes)

**PULSE**  
To run the Pulse function during Wash/Bidet/Power Wash. Water pressure is rhythmically changed from strong to weak.

**CHILD**  
Children safety mode. Nozzle moves to forward and water pressure is weak.

**SEATTEMP**  
To adjust the seat temp. by 3 steps (Low/Mid/High).  
※ Child lamp on-and-off

**WASH**  
To run the wash function (2 minutes)

**POWER WASH**  
To run the POWER WASH function (2 minutes)

**MASSAGE**  
To run the Massage (oscillating) during Wash/Bidet/Power Wash. Nozzle moves back and forth automatically. Press it again to stop the function.

**DRY**  
To run the dry function (3 minutes)

**+/-**  
Adjusting water pressure /dry level in 5 steps.

**WATER TEMP**  
To adjust the water temp. by 3 steps (Low/Mid/High)

**ENERGY SAVING**  
1 step: Automatic mode  
2 step: Learning Energy saving  
3 step: Cancel the Energy saving function

## Accessories

**Bolts**

**Nuts**

**Washers**

**Cone packings**

**Bracket Holders**

**Bracket**

**Spare nut**

**Rubber washer (for Spare nut)**

※ Optional

**Filter**

※ Optional

**T-Valve**

**Water feed hose (for toilet)**

**Water feed hose (for bidet)**

**Deodorizing Cartridge (DIB-C750 only)**

# 04. Installation

## Order of Installation

- 1 Remove the seat from the existing toilet body.
  - ▶ Release the nuts, and then remove the seat and cover from it.
  - ▶ Keep the removed seat, cover and nuts well in a proper place.



- 2 Close the water feed valve by turning it clockwise, and then drain the toilet water tank out.

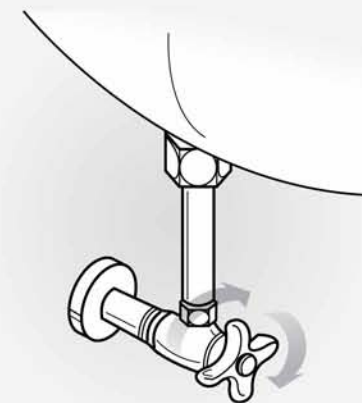

- 3 Remove the water feed pipe and then install T-valve.
  - ▶ Keep the removed water feed pipe well in a proper place. It may be useful when moving house to other place later.



- 4 Connect the toilet-use hose.

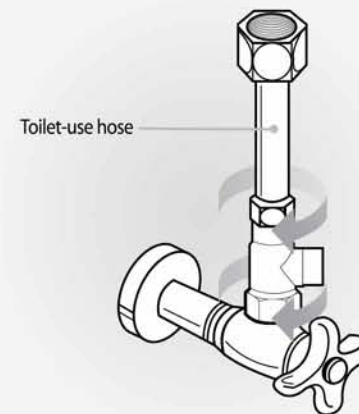

# 04. Installation

**5** Fix the bracket onto the toilet first.

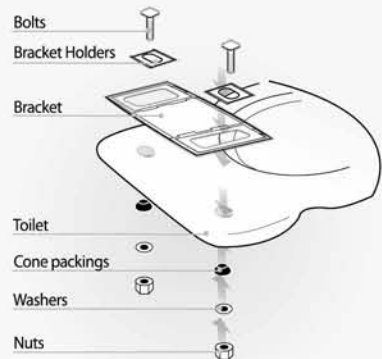

▶ Adjust the seat and the front part of toilet back and forth so that they can correspond with before fastening the nuts.

**6** Push the main body toward the bracket completely.

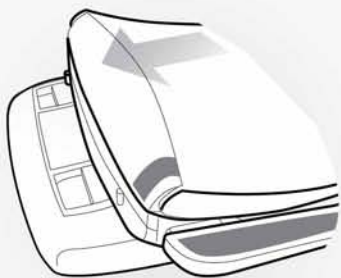

▶ Push it in until it sounds 'click'.  
▶ When the product is not installed well, it may cause leakage.

**7** After installing the filter onto the T-valve, connect the bidet-use hose to the bidet body.

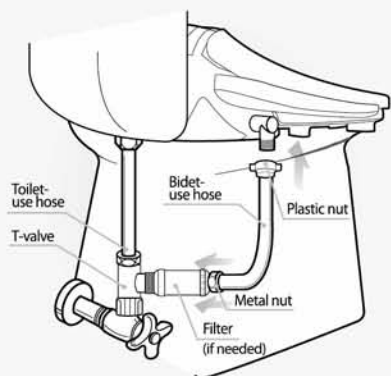

**8** Insert the deodorizing cartridge into the bidet body. (DIB-C750 only)

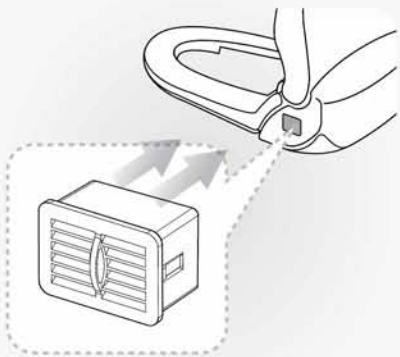

# 05. Trial Operation

## Order of Trial Operation

**1** Open the water feed valve by turning it anti-clockwise.

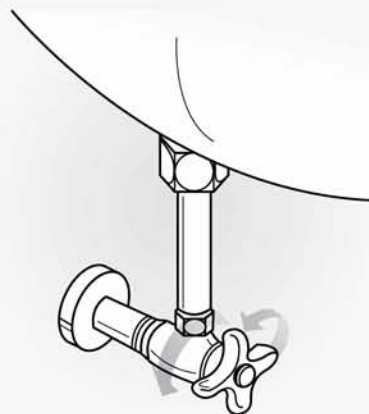

**2** Be sure of no leakage around the hose connection.

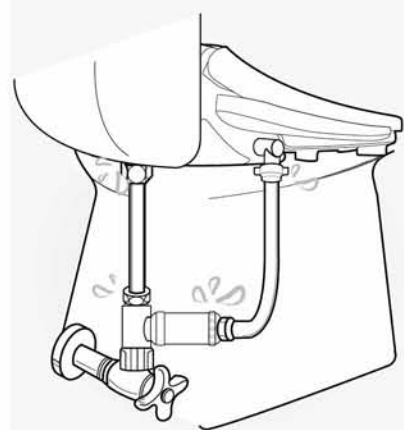

**3** Be sure that the nozzle comes out and retracts when powered on.

▶ Don't plug the power cord with wet hands.  
Risk of electric shock.



**4** Put the hand on the user sensor part of the seat. The unit will be promptly filled with water. Check if water comes out from drain hole next to the nozzle for 1~2 seconds.

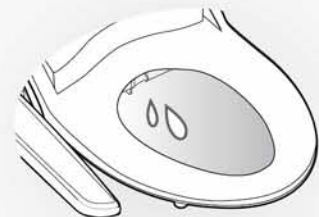

# 06. Disassembly of Product

## Order of Disassembly

- 1 Remove the power plug from the outlet.



- 2 Close the water feed valve by turning it clockwise, completely drain out the toilet water tank, release the nuts at bidet body of the bidet hose, and then remove them from main body.

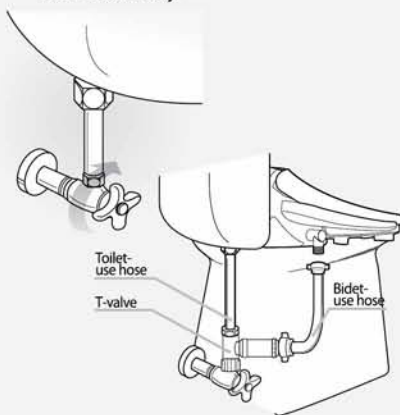

- 3 Press the button on the side of bidet, completely drain the water from the water tank. After drain the water thoroughly, pull the main body forward, and then remove it from the toilet.

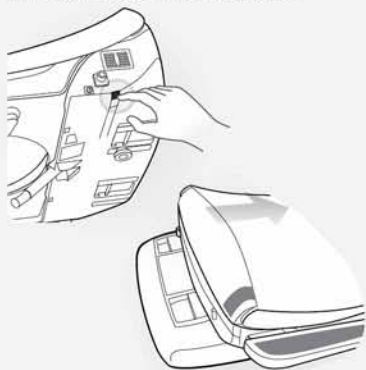

- 4 Release the nuts, and then remove the brackets from the toilet.

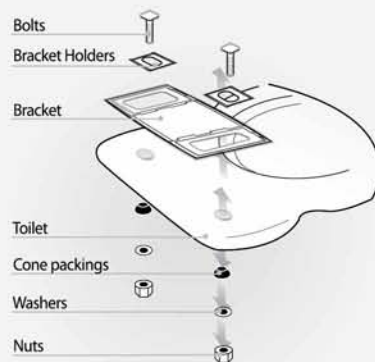

- 5 Remove bidet hose, toilet-use hose and T-valve.

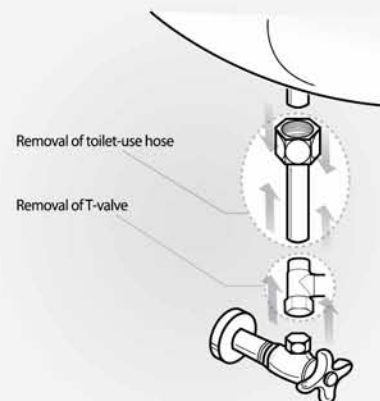

- 6 Connect the water feed pipe that was removed when the bidet was installed.

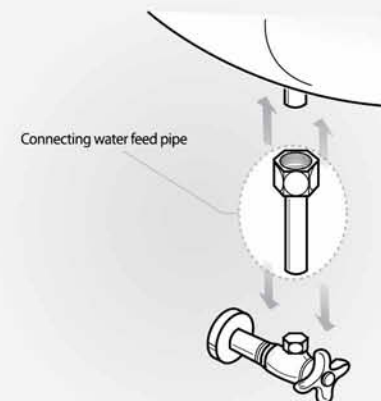

- 7 Open the water feed valve by turning it anti-clockwise. Be sure of no leakage around the water feed connection.

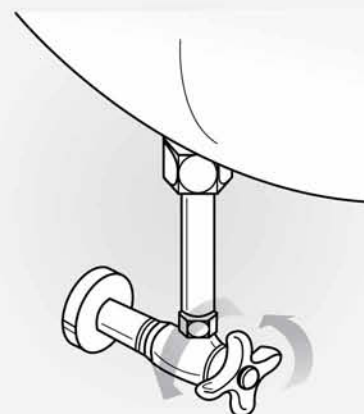

- 8 Attach to the toilet the seat and cover that were removed when the bidet was installed.





# 07. How to Use the Product

## Basic Operation Method

### 1 Sit on the toilet seat.

- ▶ Be sure to sit on the user sensor of seat.
- ▶ If the sensor is not occupied, functions will not work.
- ▶ Deodorizing function starts automatically (DIB-C750 only)

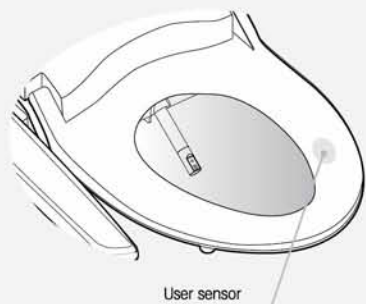

### 2 Press WASH, BIDET, Power wash buttons.

- ▶ Selected function can be used as desired.
- ▶ After Wash, Bidet and Power Wash, dryer works automatically. (Automatic dry)
- ▶ For sitz bath, press WASH again. Sitz bath works for 5 minutes at set temperature.



Wash

Bidet

Power Wash

### 3 Press the DRY button (DIB-2300, 2500 only)

- ▶ Hot air indicator lamp will light on.
- ▶ Dryer works for 3 minutes.
- ▶ It is recommended to wipe out the water on your bottom before operating the dry function for improving dry effect.



Dry

### 4 Press the STOP button.

- ▶ Any operation will stop.
- ▶ Press STOP for 3 seconds to turn off unit.



Stop

### 5 MASSAGE Wash

- ▶ When Pressing the MASSAGE button, nozzle location will be changed back and forth to wash the wider range.
- ▶ When pressing the CHILD button during the operation of MASSAGE, the moving distance can be adjusted within 5 steps.

Massage

### 6 PULSE Wash

- ▶ When the pressing PULSE button during the operation of WASH, BIDET and POWER WASH, water pressure will repeat + / - level for smooth pulsating wash.

Pulse

### 7 Water Pressure Control

- ▶ Pressing + / - button enables the control of water pressure.
- ▶ When any foreign material blocks the water pipe filter, it may cause the low water pressure. Regularly check it for its stable use.



Power ctrl

### 8 Nozzle Position Control

- ▶ Nozzle position can be controlled by pressing < / >.



Position ctrl

# 07. How to Use the Product

## Basic Operation Method

### 9 CHILD Function

- ▶ For child use, press the CHILD button first (Child lamp will light on), nozzle position, water pressure and seat temp. will be adjusted.
- ▶ Nozzle moves forward more than adult wash.
- ▶ Water pressure is weaker than adult wash.
- ▶ When CHILD mode is activating, seat temperature will be one step lower than usual.

Child

### 10 Seat Temperature Control

- ▶ When pressing the SEAT TEMP. CONTROL button, the temperature of seat can be controlled within the range of room temperature, Low/Mid/High

Seat Temp

### 11 WATER TEMP CONTROL

- ▶ When pressing the WATER TEMP. CONTROL button, the temperature of water can be controlled within the range of room temperature, Low/Mid/High

Water Temp

### 12 ENERGY SAVING Function

- ▶ Automatic Energy Saving Function
  - When pressing the button once, it enters into automatic energy saving mode. (Yellow LED lamp lights on)
  - When seat is not occupied, the seat will be heated at minimum heating temperature.
  - When sitting on the seat to use, it turns to the pre-designated temperature; when getting out of the seat, it returns to the automatic energy saving mode.
- ▶ Learning Energy Saving Function
  - When pressing the button twice, it enters into the learning energy saving mode. (Green LED lamp lights on)
  - Learning energy saving enables MICOM to detect the time frame used by users and keeps the memory for next 5 days. It releases the energy saving function 15 minutes in advance at each time frame and keeps the pre-designated temperature for an hour.
  - After an hour, the unit enters the energy saving mode.
- ▶ When pressing the button three times, the energy saving mode will be released.

\* This product adopts the instant water heating method, and does not consume the electricity to operate the water heater while not used.

### 13 Deodorizing function (DIB-2500 model only)

- ▶ When sitting on the seat, the deodorizing function starts automatically.
- ▶ Deodorizing function can be controlled by the following methods.
  - # While holding the STOP button, when pressing the hot water button once, deodorizing fan will rotate at slow speed during and even after the usage of bidet
  - # While holding the STOP button, when pressing the hot water button twice, deodorizing fan will rotate at slow speed during the usage of bidet, and at high speed when getting out of the seat.
  - # While holding the STOP button, when pressing the hot water button three times, deodorizing fan will rotate at high speed during and even after the usage of bidet
- ▶ After leaving the seat, the deodorizing function will operate for 1 minute.

### 14 Nozzle Cleaning

- ▶ While not sitting on the seat, and pressing the WASH button three times, the nozzle will move forward at its maximum distance so that the user can clean it easily (It will return after 2 minutes)
- ▶ When pressing STOP button, the nozzle will return and operate self-cleaning operation.

Longer than 3 seconds



Wash



Consult your doctor before using Power Wash function in situations of anal disease/surgery.

# 08. User Settings

● : Seat Switch 'Off' Status   ○ : Seat Switch 'On' Status   ● : Regardless of On/Off

| No               | Function                                                          | Seat Status | Switch Operation                                                                                                         | Description                                                                                                                                                                                                                                                                                                                                                                                                                                                                                                                                                                                                                                                                                                                                                                                                                                                                                                                                                                                                                                                                                                                                                                                                                                                                                                                                                                                                                                | Initial Status                                         |  |  |                          |   |   |   |   |        |          |     |     |     |     |     |     |     |    |           |           |     |    |    |           |            |    |    |    |            |            |                                 |
|------------------|-------------------------------------------------------------------|-------------|--------------------------------------------------------------------------------------------------------------------------|--------------------------------------------------------------------------------------------------------------------------------------------------------------------------------------------------------------------------------------------------------------------------------------------------------------------------------------------------------------------------------------------------------------------------------------------------------------------------------------------------------------------------------------------------------------------------------------------------------------------------------------------------------------------------------------------------------------------------------------------------------------------------------------------------------------------------------------------------------------------------------------------------------------------------------------------------------------------------------------------------------------------------------------------------------------------------------------------------------------------------------------------------------------------------------------------------------------------------------------------------------------------------------------------------------------------------------------------------------------------------------------------------------------------------------------------|--------------------------------------------------------|--|--|--------------------------|---|---|---|---|--------|----------|-----|-----|-----|-----|-----|-----|-----|----|-----------|-----------|-----|----|----|-----------|------------|----|----|----|------------|------------|---------------------------------|
| 1                | Automatic Massage Preset/Release                                  | ○           | Press MASSAGE button for 3 sec. or longer while in standby status (Same in case of releasing)                            | When pressing WASH, BIDET, POWER WASH button, MASSAGE will operate automatically even if not press the MASSAGE button.                                                                                                                                                                                                                                                                                                                                                                                                                                                                                                                                                                                                                                                                                                                                                                                                                                                                                                                                                                                                                                                                                                                                                                                                                                                                                                                     | CANCEL                                                 |  |  |                          |   |   |   |   |        |          |     |     |     |     |     |     |     |    |           |           |     |    |    |           |            |    |    |    |            |            |                                 |
| 2                | Automatic Pulse Preset/Release                                    | ○           | Press PULSE button for 3 sec. or longer while in standby status (Same in case of release)                                | When pressing WASH, BIDET, POWER WASH button, PULSE will operate automatically even if not pressing the PULSE button.                                                                                                                                                                                                                                                                                                                                                                                                                                                                                                                                                                                                                                                                                                                                                                                                                                                                                                                                                                                                                                                                                                                                                                                                                                                                                                                      | CANCEL                                                 |  |  |                          |   |   |   |   |        |          |     |     |     |     |     |     |     |    |           |           |     |    |    |           |            |    |    |    |            |            |                                 |
| 3                | Operating Signal Cancel                                           | ●           | Press MASSAGE for 3 sec.                                                                                                 | Use when turning off the operating signal                                                                                                                                                                                                                                                                                                                                                                                                                                                                                                                                                                                                                                                                                                                                                                                                                                                                                                                                                                                                                                                                                                                                                                                                                                                                                                                                                                                                  | Operating Signal is turned on                          |  |  |                          |   |   |   |   |        |          |     |     |     |     |     |     |     |    |           |           |     |    |    |           |            |    |    |    |            |            |                                 |
| 4                | Selecting the operating time of WASH, (BIDET, POWER WASH) and DRY | ●           | Press '▶' and '–' buttons for longer than 3 sec. Preset Mode: Selecting the desired time by the buttons of + / – , ◀ / ▶ | <ul style="list-style-type: none"> <li>Using + / – button, select the desired washing time.</li> </ul> <table border="1" style="margin-left: 20px;"> <tr> <td style="text-align: center;">+</td> <td></td> <td></td> <td></td> <td style="text-align: center;">–</td> </tr> <tr> <td style="text-align: center;">○</td> <td style="text-align: center;">○</td> <td style="text-align: center;">○</td> <td style="text-align: center;">○</td> <td style="text-align: center;">○</td> </tr> <tr> <td style="text-align: center;">5M</td> <td style="text-align: center;">3M</td> <td style="text-align: center;">2M</td> <td style="text-align: center;">1M</td> <td style="text-align: center;">30S</td> </tr> </table> <ul style="list-style-type: none"> <li>Using ◀ / ▶ button, select the desired drying time</li> </ul> <table border="1" style="margin-left: 20px;"> <tr> <td style="text-align: center;">◀</td> <td></td> <td></td> <td></td> <td style="text-align: center;">▶</td> </tr> <tr> <td style="text-align: center;">○</td> <td style="text-align: center;">○</td> <td style="text-align: center;">○</td> <td style="text-align: center;">○</td> <td style="text-align: center;">○</td> </tr> <tr> <td style="text-align: center;">5M</td> <td style="text-align: center;">4M</td> <td style="text-align: center;">3M</td> <td style="text-align: center;">2M</td> <td style="text-align: center;">1M</td> </tr> </table> | +                                                      |  |  |                          | – | ○ | ○ | ○ | ○      | ○        | 5M  | 3M  | 2M  | 1M  | 30S | ◀   |     |    |           | ▶         | ○   | ○  | ○  | ○         | ○          | 5M | 4M | 3M | 2M         | 1M         | Washing 2 Min.<br>Drying 3 Min. |
| +                |                                                                   |             |                                                                                                                          | –                                                                                                                                                                                                                                                                                                                                                                                                                                                                                                                                                                                                                                                                                                                                                                                                                                                                                                                                                                                                                                                                                                                                                                                                                                                                                                                                                                                                                                          |                                                        |  |  |                          |   |   |   |   |        |          |     |     |     |     |     |     |     |    |           |           |     |    |    |           |            |    |    |    |            |            |                                 |
| ○                | ○                                                                 | ○           | ○                                                                                                                        | ○                                                                                                                                                                                                                                                                                                                                                                                                                                                                                                                                                                                                                                                                                                                                                                                                                                                                                                                                                                                                                                                                                                                                                                                                                                                                                                                                                                                                                                          |                                                        |  |  |                          |   |   |   |   |        |          |     |     |     |     |     |     |     |    |           |           |     |    |    |           |            |    |    |    |            |            |                                 |
| 5M               | 3M                                                                | 2M          | 1M                                                                                                                       | 30S                                                                                                                                                                                                                                                                                                                                                                                                                                                                                                                                                                                                                                                                                                                                                                                                                                                                                                                                                                                                                                                                                                                                                                                                                                                                                                                                                                                                                                        |                                                        |  |  |                          |   |   |   |   |        |          |     |     |     |     |     |     |     |    |           |           |     |    |    |           |            |    |    |    |            |            |                                 |
| ◀                |                                                                   |             |                                                                                                                          | ▶                                                                                                                                                                                                                                                                                                                                                                                                                                                                                                                                                                                                                                                                                                                                                                                                                                                                                                                                                                                                                                                                                                                                                                                                                                                                                                                                                                                                                                          |                                                        |  |  |                          |   |   |   |   |        |          |     |     |     |     |     |     |     |    |           |           |     |    |    |           |            |    |    |    |            |            |                                 |
| ○                | ○                                                                 | ○           | ○                                                                                                                        | ○                                                                                                                                                                                                                                                                                                                                                                                                                                                                                                                                                                                                                                                                                                                                                                                                                                                                                                                                                                                                                                                                                                                                                                                                                                                                                                                                                                                                                                          |                                                        |  |  |                          |   |   |   |   |        |          |     |     |     |     |     |     |     |    |           |           |     |    |    |           |            |    |    |    |            |            |                                 |
| 5M               | 4M                                                                | 3M          | 2M                                                                                                                       | 1M                                                                                                                                                                                                                                                                                                                                                                                                                                                                                                                                                                                                                                                                                                                                                                                                                                                                                                                                                                                                                                                                                                                                                                                                                                                                                                                                                                                                                                         |                                                        |  |  |                          |   |   |   |   |        |          |     |     |     |     |     |     |     |    |           |           |     |    |    |           |            |    |    |    |            |            |                                 |
| 5                | Selecting the speed of deodorizing fan:                           | ●           | While pressing the STOP button, press the Water Temp button                                                              | Press the Water Temp button to select the desired speed.                                                                                                                                                                                                                                                                                                                                                                                                                                                                                                                                                                                                                                                                                                                                                                                                                                                                                                                                                                                                                                                                                                                                                                                                                                                                                                                                                                                   | High speed while seated,<br>High speed while unseated. |  |  |                          |   |   |   |   |        |          |     |     |     |     |     |     |     |    |           |           |     |    |    |           |            |    |    |    |            |            |                                 |
|                  |                                                                   |             |                                                                                                                          | <table border="1" style="margin-left: 20px;"> <thead> <tr> <th colspan="3">Water Temp (LED)</th> <th colspan="2">Speed of Deodorizing Fan</th> </tr> <tr> <th>○</th> <th>○</th> <th>○</th> <th>Seated</th> <th>Unseated</th> </tr> </thead> <tbody> <tr> <td>OFF</td> <td>OFF</td> <td>OFF</td> <td>OFF</td> <td>OFF</td> </tr> <tr> <td>OFF</td> <td>OFF</td> <td>ON</td> <td>Low speed</td> <td>Low speed</td> </tr> <tr> <td>OFF</td> <td>ON</td> <td>ON</td> <td>Low speed</td> <td>High speed</td> </tr> <tr> <td>ON</td> <td>ON</td> <td>ON</td> <td>High speed</td> <td>High speed</td> </tr> </tbody> </table>                                                                                                                                                                                                                                                                                                                                                                                                                                                                                                                                                                                                                                                                                                                                                                                                                     | Water Temp (LED)                                       |  |  | Speed of Deodorizing Fan |   | ○ | ○ | ○ | Seated | Unseated | OFF | OFF | OFF | OFF | OFF | OFF | OFF | ON | Low speed | Low speed | OFF | ON | ON | Low speed | High speed | ON | ON | ON | High speed | High speed |                                 |
| Water Temp (LED) |                                                                   |             | Speed of Deodorizing Fan                                                                                                 |                                                                                                                                                                                                                                                                                                                                                                                                                                                                                                                                                                                                                                                                                                                                                                                                                                                                                                                                                                                                                                                                                                                                                                                                                                                                                                                                                                                                                                            |                                                        |  |  |                          |   |   |   |   |        |          |     |     |     |     |     |     |     |    |           |           |     |    |    |           |            |    |    |    |            |            |                                 |
| ○                | ○                                                                 | ○           | Seated                                                                                                                   | Unseated                                                                                                                                                                                                                                                                                                                                                                                                                                                                                                                                                                                                                                                                                                                                                                                                                                                                                                                                                                                                                                                                                                                                                                                                                                                                                                                                                                                                                                   |                                                        |  |  |                          |   |   |   |   |        |          |     |     |     |     |     |     |     |    |           |           |     |    |    |           |            |    |    |    |            |            |                                 |
| OFF              | OFF                                                               | OFF         | OFF                                                                                                                      | OFF                                                                                                                                                                                                                                                                                                                                                                                                                                                                                                                                                                                                                                                                                                                                                                                                                                                                                                                                                                                                                                                                                                                                                                                                                                                                                                                                                                                                                                        |                                                        |  |  |                          |   |   |   |   |        |          |     |     |     |     |     |     |     |    |           |           |     |    |    |           |            |    |    |    |            |            |                                 |
| OFF              | OFF                                                               | ON          | Low speed                                                                                                                | Low speed                                                                                                                                                                                                                                                                                                                                                                                                                                                                                                                                                                                                                                                                                                                                                                                                                                                                                                                                                                                                                                                                                                                                                                                                                                                                                                                                                                                                                                  |                                                        |  |  |                          |   |   |   |   |        |          |     |     |     |     |     |     |     |    |           |           |     |    |    |           |            |    |    |    |            |            |                                 |
| OFF              | ON                                                                | ON          | Low speed                                                                                                                | High speed                                                                                                                                                                                                                                                                                                                                                                                                                                                                                                                                                                                                                                                                                                                                                                                                                                                                                                                                                                                                                                                                                                                                                                                                                                                                                                                                                                                                                                 |                                                        |  |  |                          |   |   |   |   |        |          |     |     |     |     |     |     |     |    |           |           |     |    |    |           |            |    |    |    |            |            |                                 |
| ON               | ON                                                                | ON          | High speed                                                                                                               | High speed                                                                                                                                                                                                                                                                                                                                                                                                                                                                                                                                                                                                                                                                                                                                                                                                                                                                                                                                                                                                                                                                                                                                                                                                                                                                                                                                                                                                                                 |                                                        |  |  |                          |   |   |   |   |        |          |     |     |     |     |     |     |     |    |           |           |     |    |    |           |            |    |    |    |            |            |                                 |

| No | Function                                                 | Seat Status | Switch Operation                                                        | Description                                                                                                                                                                      | Initial Status                            |
|----|----------------------------------------------------------|-------------|-------------------------------------------------------------------------|----------------------------------------------------------------------------------------------------------------------------------------------------------------------------------|-------------------------------------------|
| 6  | Saving the washing water pressure /nozzle position       | ○           | Pressing WASH button for 3 sec. during the operation of WASH            | Saving the present operating condition. Even if other user uses the different pressure and position, when he gets out of the seat, it will automatically return to preset level. | Water pressure 3 steps<br>Nozzle 3 steps. |
| 7  | Saving the bidet water pressure and nozzle position      | ○           | Pressing BIDET button for 3 sec during the operation of BIDET           | Saving the present operating condition. Even if other user uses the different pressure and position, when he gets out of the seat, it will automatically return to preset level. | Water pressure 3 steps<br>Nozzle 3 steps. |
| 8  | Saving the Power Wash water pressure and nozzle position | ○           | Pressing Power Wash button for 3 sec during the operation of Enema Wash | Saving the present operating condition. Even if other user uses the different pressure and position, when he gets out of the seat, it will automatically return to preset level. | Water pressure 3 steps<br>Nozzle 3 steps. |
| 9  | Turning off                                              | ●           | Press STOP button for 3 sec.                                            | Press one of STOP, WASH, BIDET and POWER WASH to turn on the unit.                                                                                                               |                                           |
| 10 | Initialization                                           | ●           | Press STOP button for 5 sec.                                            | Initializing all the functions to the initial status.                                                                                                                            |                                           |

dib

# 09. Maintenance & Cleaning

## Cleaning of Water pipe filter

- 1 Close the water feed valve by turning it clockwise.
- 2 Disconnect the water supply hose. Take the screen filter out and clean it with soft brush. (e.g. toothbrush)
- 3 After cleaning, place it back. Then connect the water supply hose.
- 4 Open the water feed valve by turning it anti-clockwise.

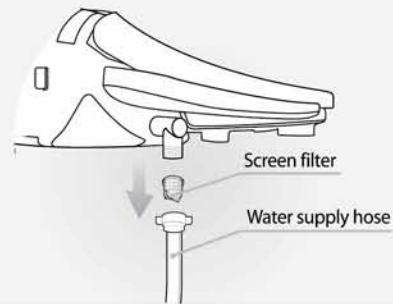

## Cleaning of Nozzle

- 1 Press the WASH button for 3 seconds, and then the nozzle will move forward and stop (for 2 minutes)
- 2 Clean the nozzle with a unused toothbrush, etc., and press the STOP button, then it will return to the original place for self cleaning.



## Cleaning of Bidet Body

- 1 Exterior surface of bidet is made of plastic material, which may be damaged by scrubber, chemicals, etc.
- 2 Wipe the surface with a soft cloth wet and squeezed completely. Don't spray water directly onto the surface with the bath-use shower device.
- 3 Clean the body after removing the power plug from the outlet. Be sure no water splash to the power plug or outlet.
- 4 Don't touch the power outlet with wet hand. Risk of electric shock.



## Drainage of Hot Water Tank

- 1 Remove the power plug from the outlet.
- 2 Close the water feed valve by turning it anti-clockwise.
- 3 Press the button on the side of main body.

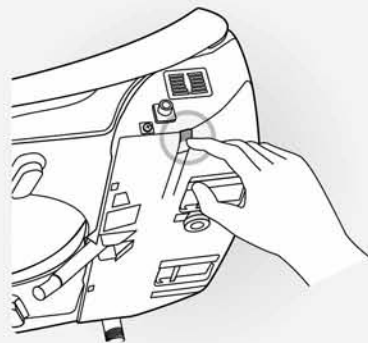

## Maintenance during winter season

- 1 Insert the power plug into the outlet and be sure if the power is supplied.
- 2 When it is not used for a long time, drain the water from the water tank

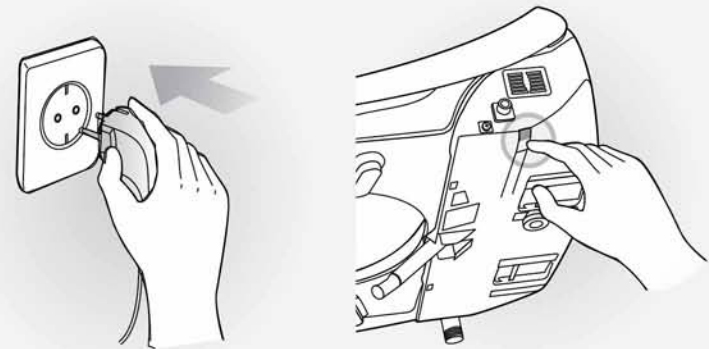

## Do not throw away

We are committed to protection the environment.

Please help us by disposing of this product in a responsible way when it reaches the end of its service life, to prevent certain substances contained in electric and electronic products from harming public health or the environment. The symbol means that the products must not be thrown away with other household waste: at the end of its service life, it must be taken at no charge to you to the waste-collection centers provided for the purpose by the authorities in your country.

Or to be distributor from whom you purchase a new product that is equivalent to or that performs the same functions as this product. This latter option may not be available in some countries.



# 10. Before requesting repair

※ Please check the following points before requesting the repair of the product.

| Signs to occur              | Matters to be checked                                                                                                                                                                                                                            |
|-----------------------------|--------------------------------------------------------------------------------------------------------------------------------------------------------------------------------------------------------------------------------------------------|
| Completely out of operation | <ul style="list-style-type: none"> <li>• Check if the power plug is not connected.</li> <li>• Check the power failure.</li> </ul>                                                                                                                |
| Water does not spray out    | <ul style="list-style-type: none"> <li>• Check if the water supply is suspended.</li> <li>• Check if water feed valve is locked</li> <li>• Check if nozzle is blocked by foreign material</li> <li>• Check if connection hose is bent</li> </ul> |
| Water pressure is low       | <ul style="list-style-type: none"> <li>• Check if water pipe filter is blocked by foreign material.</li> <li>• Check if the water pressure is set at too low level</li> </ul>                                                                    |
| Water is not warm enough    | <ul style="list-style-type: none"> <li>• Check if its temperature is set at 'Off' or 'Low'.</li> </ul>                                                                                                                                           |
| Seat is not warm enough     | <ul style="list-style-type: none"> <li>• Check if its temperature is set at 'Off' or 'Low'</li> </ul>                                                                                                                                            |

## Self-Diagnosis Table

※ When any abnormal phenomenon occurs, please refer to the following table, and inform the exact status at the time of requesting A/S service.

| No | Self-Diagnosis Phenomenon                                                                | Way of Indication                                                         |
|----|------------------------------------------------------------------------------------------|---------------------------------------------------------------------------|
| 1  | Inlet hot water sensor disconnected or not inserted                                      | LED Hot Water Temp. Med & Low blinked simultaneously                      |
| 2  | Inlet hot water sensor short-circuited and temperature excessively increased.            | LED Hot Water Temp. Med & High blinked simultaneously                     |
| 3  | Outlet hot water sensor disconnected or not inserted                                     | LED Hot Water Temp. Med & Low blinked separately                          |
| 4  | Outlet hot water sensor short-circuited and temperature excessively increased.           | LED Hot Water Temp. Med & High blinked separately                         |
| 5  | Seat sensor disconnected or not inserted                                                 | LED seat temperature Low blinked                                          |
| 6  | Seat sensor short-circuited and temperature excessively increased                        | LED seat temperature High blinked                                         |
| 7  | Air Pump motor disconnected or not inserted                                              | WASH, BIDET, POWER WASH are out of operation                              |
| 8  | Air pump motor short-circuited                                                           |                                                                           |
| 9  | Deodorizing motor: Check the cycle of rotation at low speed                              | Buzzer sounds.<br>Abnormal condition is differently indicated by symptoms |
| 10 | Stoppage of motor due to the over-current of deodorization motor                         |                                                                           |
| 11 | Heat stops in case of low speed rotation of drying motor                                 |                                                                           |
| 12 | Heater and drying motor simultaneously stop in case of the over-current of drying motor. |                                                                           |

# 11. Product Specifications

| Item                                     |                        | DIB-C750                            | DIB-C730                    |
|------------------------------------------|------------------------|-------------------------------------|-----------------------------|
| Rated Voltage                            |                        | AC 220V ~ 240V, 50Hz                |                             |
| Max. Consumption Power                   |                        | 1670W                               |                             |
| Power Cord Length                        |                        | 1.8M                                |                             |
| Water Feed Method                        |                        | Directly Connected to Water Pipe    |                             |
| Water Pressure                           |                        | 0.7~7.5kgf/cm <sup>2</sup>          |                             |
| Wash                                     | Feeding Volume         | Wash                                | 0.7 ℓ/min                   |
|                                          |                        | Bidet                               | 0.7 ℓ/min                   |
|                                          |                        | Power Wash                          | 0.6 ℓ/min                   |
|                                          | Water Pressure Control | 5-Step Control                      |                             |
|                                          | Temp. Control          | Room Temp. ~ 38°C                   |                             |
|                                          | Heater Capa.           | 1600W                               |                             |
|                                          | Safety Device          | Temp. Fuse, Thermo Switch           |                             |
| Heated Seat                              | Temp. Control          | Room Temp. ~ 42°C                   |                             |
|                                          | Heater Capa.           | 55W                                 |                             |
|                                          | Safety Device          | Temp. Fuse                          |                             |
| Dry                                      | Temp. Control          | Room Temp. ~ 50°C                   |                             |
|                                          | Heater Capa.           | 250W                                |                             |
|                                          | Safety Device          | Temp. Fuse, Bi-metal                |                             |
| Deodorization                            |                        | Catalytic Deodorization             | -                           |
| Product Dimension<br>※ inch(mm)          | Elongated              | 18.5"(470) x 20.8"(528) x 6.5"(165) |                             |
|                                          | Round                  | 18.5"(470) x 19.5"(496) x 6.5"(165) |                             |
| Product Weight /Gross weight<br>※ lb(kg) | Elongated              | 11.0 (5kg) / 17.6 (8kg)             | 10.8 (4.9kg) / 17.4 (7.9kg) |
|                                          | Round                  | 10.8(4.9kg) / 17.4 (7.9kg)          | 10.6 (4.8kg) / 17.2 (7.8kg) |

# 12. Comparison Chart

|                               | Function                | DIB-C750 | DIB-C730 |
|-------------------------------|-------------------------|----------|----------|
| Wash/Dry Function             | Wash                    | ●        | ●        |
|                               | Bidet                   | ●        | ●        |
|                               | Power Wash              | ●        | ●        |
|                               | Dry                     | ●        | ●        |
|                               | Deodorization           | ●        |          |
|                               | Bubble Wash             | ●        | ●        |
|                               | Built in pump motor     | ●        | ●        |
| Convenient / Comfort Function | Automatic Energy Saving | ●        | ●        |
|                               | Learning Energy Saving  | ●        | ●        |
|                               | Massage                 | ●        | ●        |
|                               | Pulse                   | ●        | ●        |
|                               | Instant heating         | ●        | ●        |
|                               | Warm Seat               | ●        | ●        |
|                               | Soft Closing Lid & Seat | ●        | ●        |
|                               | Detachable Main Body    | ●        | ●        |
|                               | Child                   | ●        | ●        |
|                               | Stainless steel nozzle  | ●        | ●        |

## Dimension diagrams

inch (mm)

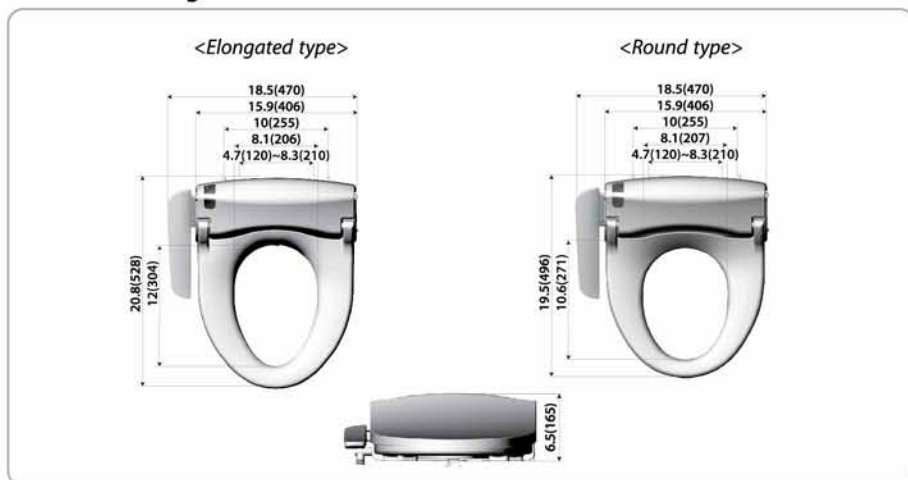

# 13. Memo

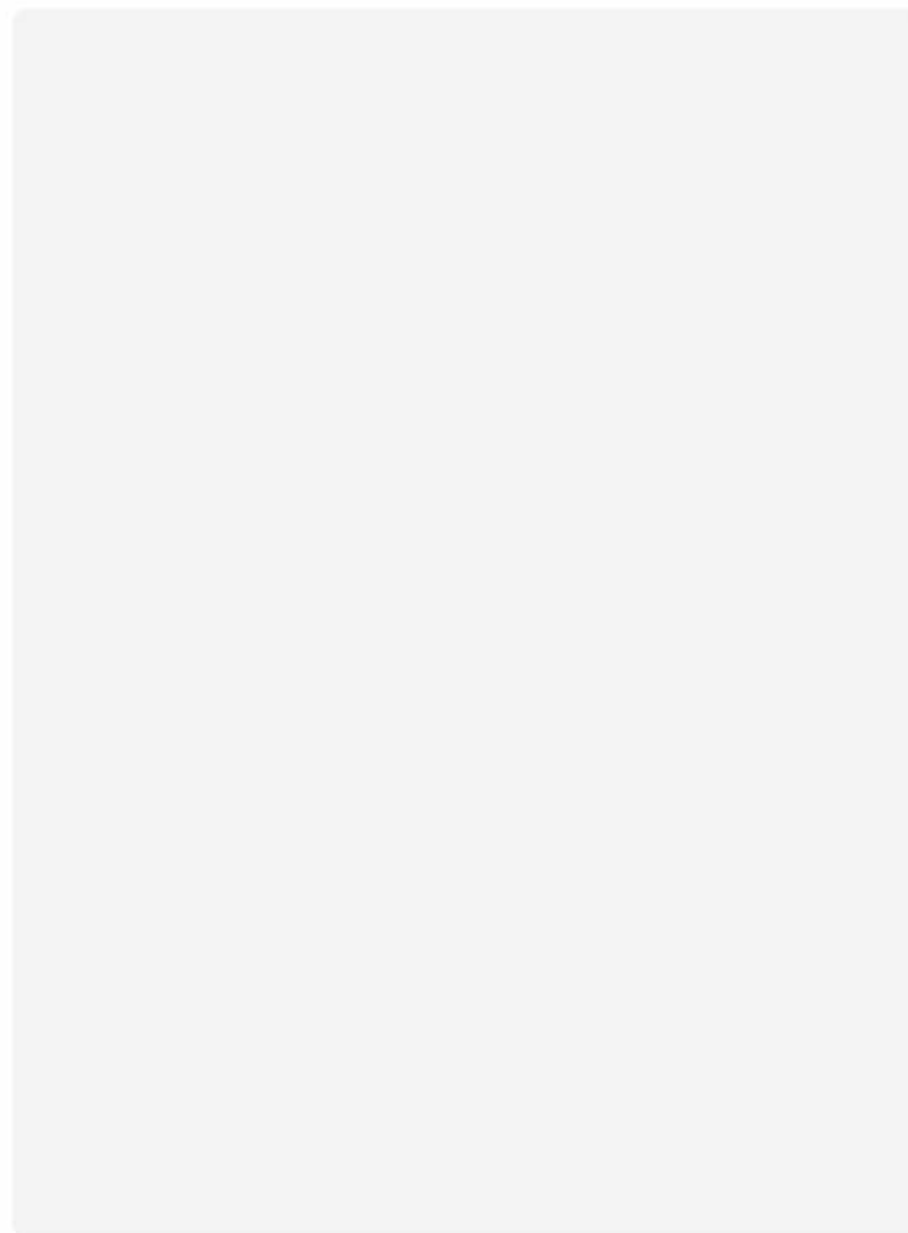

# 13.Memo

# 13.Memo

# 13. Memo

# 14. WARRANTY INFORMATION

## - WARRANTY -

1. We hereby guarantee the product as follow in accordance with the regulation of consumer damage compensation.
2. In case of failure of the product, please inform the distributor where you purchased the product.
3. Product warranty will be effective for 5 years since the product has been discontinued.

|                          |         |                                             |
|--------------------------|---------|---------------------------------------------|
| Product Name             |         | Warranty Period                             |
| Model Name               |         | One (1) year<br>since the date<br>purchased |
| Date Purchased           |         |                                             |
| SER. No.                 |         |                                             |
| Customer's<br>Address    | Name    |                                             |
|                          | Tel.No  |                                             |
| Distributor's<br>Address | Name    |                                             |
|                          | Tel.No. |                                             |

### Regarding Product Warranty Regulation...

1. We will repair the product at free of charge in case it was failed under the normal operating condition in accordance with the user's guide during the warranty period.
2. Although it is within the warranty period, we will charge the repair service fee etc. (repair + product + travel expense) if it falls under the following cases.

### Voiding warranty

1. Defects occurred from the user's careless handling
2. Defects occurred from the usage with incorrect power voltage (E.g., 220V was used to the 110V product.)
3. Defects occurred from the improper repair done by the person other than our service engineer.
4. Defects occurred from Force Majeure (fire, salt, flood, etc.)
5. Failure or damage due to the drop, etc. (user's mis-handling) during the operation after installed
6. Defect occurred from the interior modification at user's discretion
7. In case the life cycle of the part expired

Mail, email or fax the warranty form to:

**YOUR LOCAL DEALER FIRST where you bought this appliance**

If your dealer is unable to assist you

**LS Daewon**  
LIVING SOLUTION

94, Robot land-ro 249beon-gil, Seo-gu, Incheon, Korea  
[www.lsdawon.co.kr](http://www.lsdawon.co.kr)