



Uspa ::::





**WE ARE  
JUST IMITATING  
NATURE**



# INDEX

indice

## USPA ELECTRONIC BIDETS

<b>6035R</b>	18
<b>6235</b>	26
<b>6210</b>	32
<b>7035R</b>	40
<b>7235</b>	48
<b>7000</b>	54

## MAIN FEATURES | CARATTERISTICHE 60

### ECOLOGICAL BIDET

<b>M400</b>	72
-------------	----

### USPA COMFORT + WC

<b>SOLO WALL-HUNG   SOSPESO</b>	90
<b>DUO FLOOR   TERRA</b>	94
<b>VELIS 57 WALL-HUNG   SOSPESO</b>	98
<b>VELIS 57 FLOOR   TERRA</b>	102

### USPA DESIGN + WC

<b>ZERO WALL-HUNG   SOSPESO</b>	112
<b>ZERO FLOOR   TERRA</b>	116
<b>SFERA WALL-HUNG   SOSPESO</b>	120
<b>SFERA FLOOR   TERRA</b>	124

## ACCESSORIES | ACCESSORI 132

## DETAILS | DETTAGLI 136



# USPA Collection

ELECTRONIC BIDETS

6 MODELS | 6 MODELLI



6035R

**Exclusive design**  
Complete comfort

**Design esclusivo**  
Comfort senza compromessi

AVAILABLE SHAPES  
FORME DISPONIBILI

STANDARD | COMFORT | DESIGN



6235

**Technology**  
at the service of hygiene

**Tecnologia**  
al servizio dell'igiene

AVAILABLE SHAPES  
FORME DISPONIBILI

STANDARD | COMFORT



6210

**Gentle and comfortable**

**Delicato e confortevole**

AVAILABLE SHAPES  
FORME DISPONIBILI

STANDARD | COMFORT



7035R

**Your private SPA**

**La tua SPA privata**

AVAILABLE SHAPES  
FORME DISPONIBILI

STANDARD | COMFORT | DESIGN



7235

**Total well-being**

**Benessere assoluto**

AVAILABLE SHAPES  
FORME DISPONIBILI

STANDARD | COMFORT | DESIGN



7000

**Natural hygiene**  
the simplest way

**Igiene naturale**  
in tutta semplicità

AVAILABLE SHAPES  
FORME DISPONIBILI

STANDARD | COMFORT | DESIGN

**3 SHAPES**  
FOR A  
BETTER  
ADAPTABILITY



# 16 USPA ELECTRONIC BIDETS

16 BIDET ELETTRONICI USPA

**IT'S TIME  
TO RELAX**



# USPA 6000 SERIES







Uspa   
6035R







### 6035RS

L: 397; P: 490; H: 144  
Dimensions (mm) | Dimensioni (mm)

4.4 Kg  
Net weight | Peso netto

### 6035R

L: 392; P: 520; H: 144  
Dimensions (mm) | Dimensioni (mm)

4.4 Kg  
Net weight | Peso netto

### 6035RU

L: 388; P: 504; H: 144  
Dimensions (mm) | Dimensioni (mm)

4.4 Kg  
Net weight | Peso netto

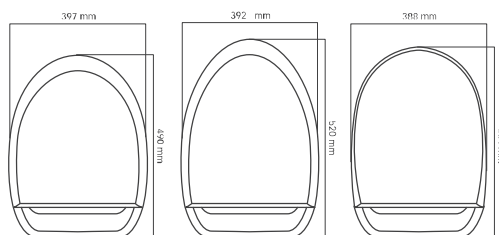

6035RS Standard

6035R Comfort

6035RU Design

### Technical details | Caratteristiche tecniche

#### 6035RS - 6035R - 6035RU

Personalized controls   Controlli funzioni		Wireless Remote Control - Batteries (AAA x 3)   Telecomando - Pile AAA x 3
Power supply   Alimentazione		AC 220 - 240 V 50 Hz
Maximum power consumption   Consumo elettrico massimo		1160 - 1380 W
Tap water pressure   Pressione mandata acqua		0.79 - 7.40 Atm
Heated seat   Sedile riscaldato	Temperature   Temperatura	Adjustable (3 levels) / 34 °C - 40 °C   3 livelli di regolazione / 34 °C - 40 °C
	Safety device   Dispositivo di sicurezza	Temp. fuse   Fusibile termico
	Power consumption   Consumo elettrico	55 - 65 W
Hygiene   Igiene	Temperature   Temperatura	Adjustable (3 levels) / 34 °C - 40 °C   3 livelli di regolazione / 34 °C - 40 °C
	Water spray   Intensità getto	Adjustable (5 levels - max 1 l/min)   5 livelli di regolazione (max 1 l/min)
	Safety devices   Dispositivi di sicurezza	Temp. fuse   Fusibile termico Thermal switch   Interruttore termico Floating switch   Interruttore a galleggiante
	Power consumption   Consumo elettrico	1100 - 1309 W
Air dryer   Asciugatura	Temperature   Temperatura	Adjustable (5 levels)   5 livelli di regolazione
	Safety device   Dispositivo di sicurezza	Temp. fuse   Fusibile termico
	Power consumption   Consumo elettrico	280 - 333 W
Electricity safety protection   Dispositivo di sicurezza elettrica		15 mA - GFCI
Power cord length (mm)   Lunghezza cavo alimentazione (mm)		1800 mm
N° of wands   N° ugelli		2
Warranty   Garanzia		2 years   2 anni

Degree of Protection: IP 24 | Grado di protezione: IP 24

# FUNCTIONS funzioni









Uspa  
6235



### 6235S

Li 469; P: 490; H: 144  
Dimensions (mm) | Dimensioni (mm)

4.4 Kg  
Net weight | Peso netto

### 6235

Li 467; P: 520; H: 144  
Dimensions (mm) | Dimensioni (mm)

4.4 Kg  
Net weight | Peso netto

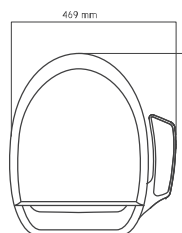

6235S Standard

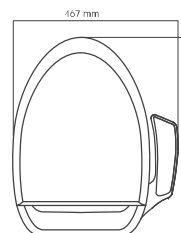

6235 Com ort

### Technical details | Caratteristiche tecniche 6235S - 6235

Personalized controls   Controllo funzioni		Control panel   Pannello di controllo
Power supply   Alimentazione		AC 220 - 240 V 50 Hz
Maximum power consumption   Consumo elettrico massimo		1160 - 1380 W
Tap water pressure   Pressione mandata acqua		0.79 - 7.40 Atm
Heated seat   Sedile riscaldato	Temperature   Temperatura	Adjustable (3 levels) / 34 °C - 40 °C   3 livelli di regolazione / 34 °C - 40 °C
	Safety device   Dispositivo di sicurezza	Temp. fuse   Fusibile termico
	Power consumption   Consumo elettrico	55 - 65 W
Hygiene   Igiene	Temperature   Temperatura	Adjustable (3 levels) / 34 °C - 40 °C   3 livelli di regolazione / 34 °C - 40 °C
	Water spray   Intensità getto	Adjustable (5 levels - max 1 l/min)   5 livelli di regolazione (max 1 l/min)
	Safety devices   Dispositivi di sicurezza	Temp fuse   Fusibile termico Thermal switch   Interruttore termico Floating switch   Interruttore a galleggiante
	Power consumption   Consumo elettrico	1100 - 1309 W
Air dryer   Asciugatura	Temperature   Temperatura	Adjustable (5 levels)   5 livelli di regolazione
	Safety device   Dispositivo di sicurezza	Temp. fuse   Fusibile termico
	Power consumption   Consumo elettrico	280 - 333 W
Electricity safety protection   Dispositivo di sicurezza elettrica		15 mA - GFCI
Power cord length (mm)   Lunghezza cavo alimentazione (mm)		1800 mm
N° of wands   N° ugelli		2
Warranty   Garanzia		2 years   2 anni

Degree of Protection: IP 24 | Grado di protezione IP 24

## FUNCTIONS funzioni









Uspa   
6210



### 6210S

L: 469; P: 490; H: 144  
Dimensions (mm) | Dimensioni (mm)

4.2 Kg  
Net weight | Peso netto

### 6210

L: 467; P: 520; H: 144  
Dimensions (mm) | Dimensioni (mm)

4.2 Kg  
Net weight | Peso netto

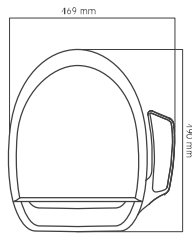

6210S Standard

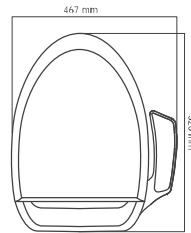

6210 Comfort

### Technical details | Caratteristiche tecniche 6210S - 6210

Personalized controls   Controllo funzioni	Control panel   Pannello di controllo
Power supply   Alimentazione	AC 220 - 240 V 50 Hz
Maximum power consumption   Consumo elettrico massimo	1160 - 1380 W
Tap water pressure   Pressione mandata acqua	0,79 - 7.40 Atm
Heated seat   Sedile riscaldato	Temperature   Temperatura Adjustable (3 levels) / 34 °C - 40 °C   3 livelli di regolazione / 34 °C - 40 °C
	Safety device   Dispositivo di sicurezza Temp. fuse   Fusibile termico
	Power consumption   Consumo elettrico 55 - 65 W
Hygiene   Igiene	Temperature   Temperatura Adjustable (3 levels) / 34 °C - 40 °C   3 livelli di regolazione / 34 °C - 40 °C
	Water spray   Intensità getto Adjustable (5 levels - max 1 l/min)   5 livelli di regolazione (max 1 l/min)
	Safety devices   Dispositivi di sicurezza Temp fuse   Fusibile termico Thermal switch   Interruttore termico Floating switch   Interruttore a galleggiante
	Power consumption   Consumo elettrico 1100 - 1309 W
Electricity safety protection   Dispositivo di sicurezza elettrica	15 mA - GFCI
Power cord length (mm)   Lunghezza cavo alimentazione (mm)	1800 mm
N° of wands   N° ugelli	2
Warranty   Garanzia	2 years   2 anni

Degree of Protection: IP 24 | Grado di protezione: IP 24

## FUNCTIONS funzioni

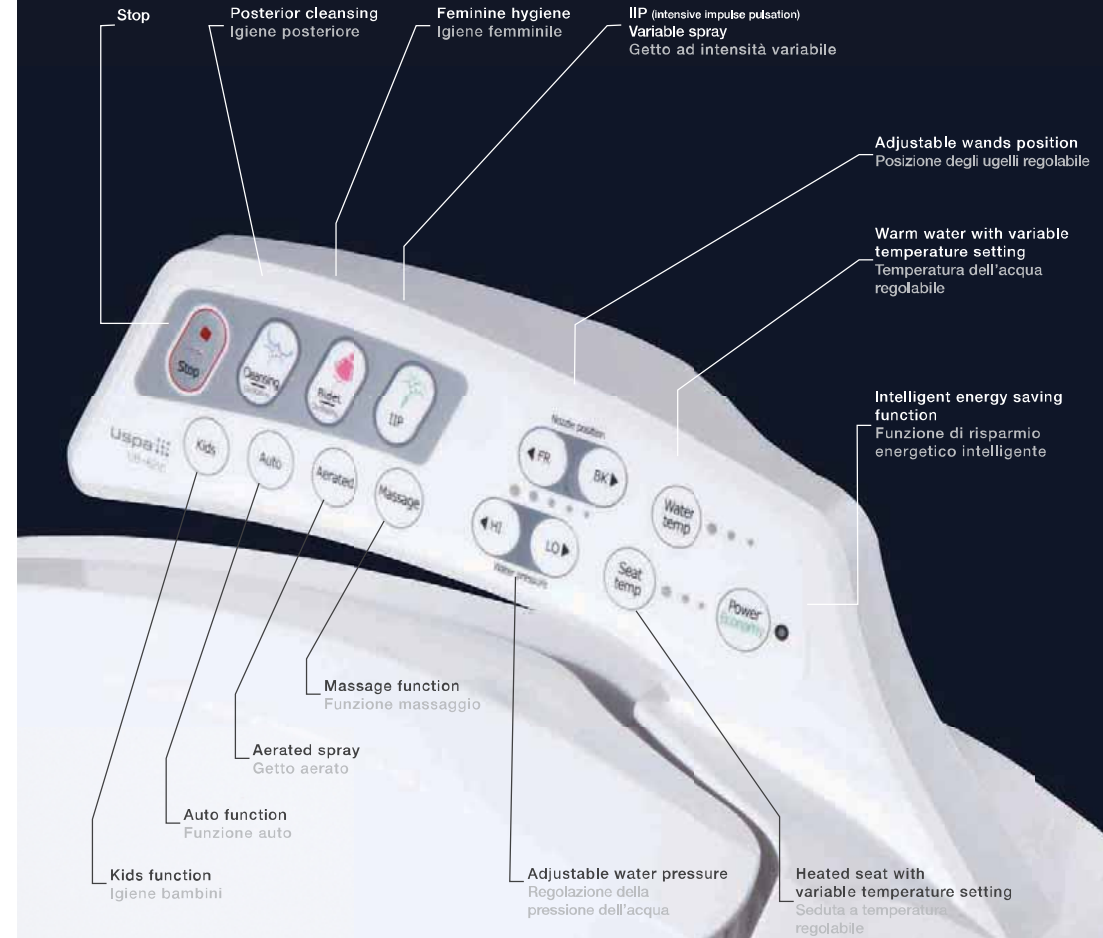





# SOFT CLOSING

CHIUSURA DOLCE



# USPA 7000 SERIES





Uspa   
**7035R**





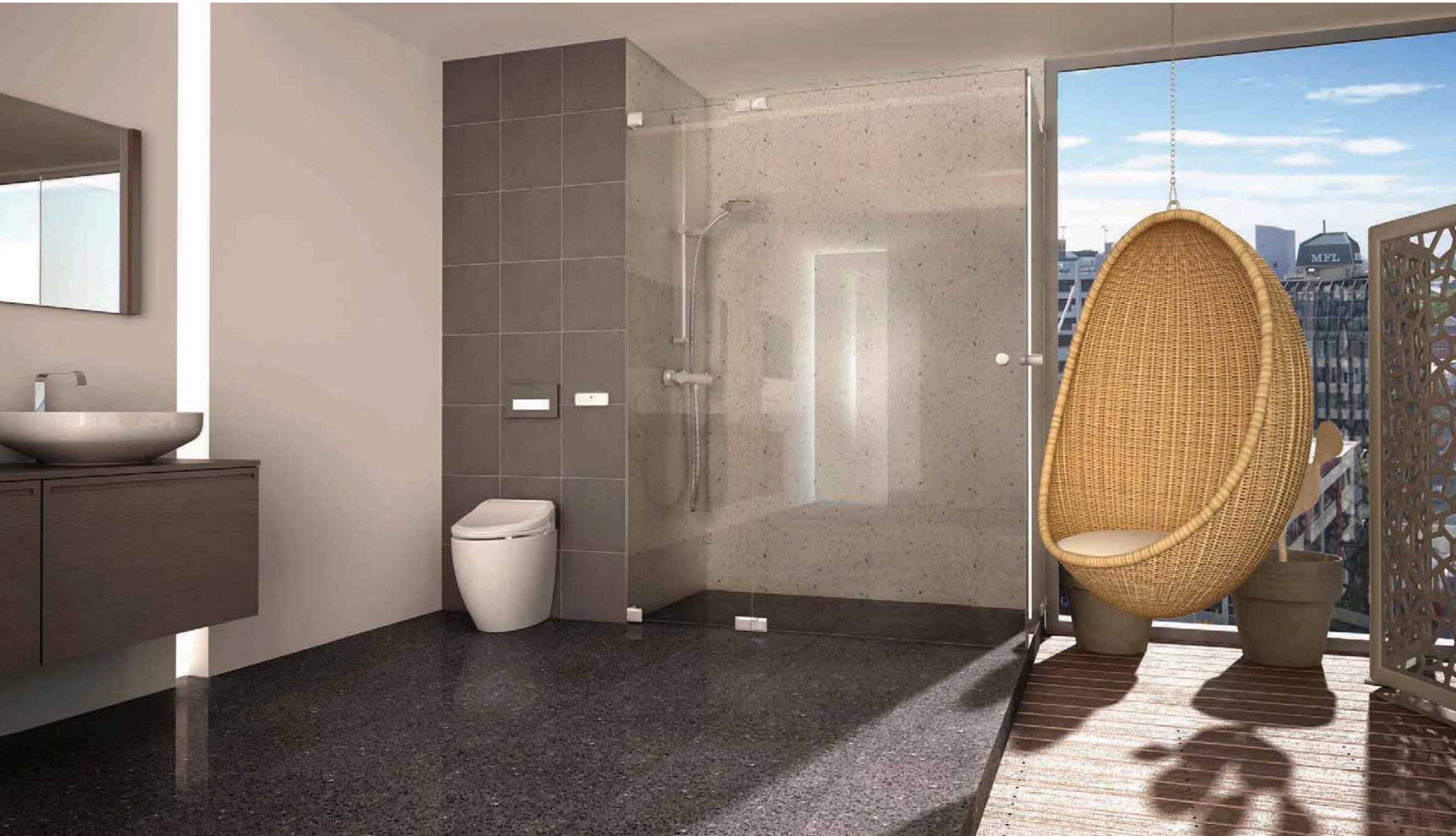

### 7035RS

L: 397; P: 490; H: 155  
Dimensions (mm) | Dimensioni (mm)

4.2 Kg  
Net weight | Peso netto

### 7035R

L: 393; P: 520; H: 155  
Dimensions (mm) | Dimensioni (mm)

4.2 Kg  
Net weight | Peso netto

### 7035RU

L: 388; P: 504; H: 155  
Dimensions (mm) | Dimensioni (mm)

4.2 Kg  
Net weight | Peso netto

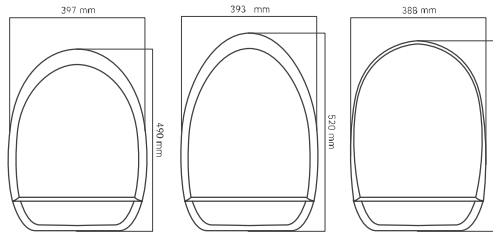

7035RS Standard

7035R Comfort

7035RU Design

### Technical details | Caratteristiche tecniche 7035RS - 7035R - 7035RU

Personalized controls   Controlli funzioni	Wireless Remote Control - Batteries (AAA x 3)   Telecomando - Pile AAA x 3
Power supply   Alimentazione	AC 220 - 240 V - 50 Hz
Maximum power consumption   Consumo elettrico massimo	1660 - 1975 W
Tap water pressure   Pressione mandata acqua	0.50 - 7.40 Atm
Heated seat   Sedile riscaldato	Temperature   Temperatura Adjustable (3 levels) / 34 °C - 40 °C   3 livelli di regolazione / 34 °C - 40 °C
	Safety device   Dispositivo di sicurezza Temp. fuse   Fusibile termico
	Power consumption   Consumo elettrico 55 - 65 W
Hygiene   Igiene	Temperature   Temperatura Adjustable (3 levels) / 34 °C - 40 °C   3 livelli di regolazione / 34 °C - 40 °C
	Water spray   Intensità getto Adjustable (5 levels - max 750 ml/min)   5 livelli di regolazione (max 750 ml/min)
	Safety devices   Dispositivi di sicurezza Temp. fuse   Fusibile termico Thermal switch   Interruttore termico Floating switch   Interruttore a galleggiante
	Power consumption   Consumo elettrico 1600 - 1905 W
Air dryer   Asciugatura	Temperature   Temperatura Adjustable (5 levels)   5 livelli di regolazione
	Safety device   Dispositivo di sicurezza Temp. fuse   Fusibile termico
	Power consumption   Consumo elettrico 280 - 333 W
Electricity safety protection   Dispositivo di sicurezza elettrica	15 mA - GFCI
Power cord length (mm)   Lunghezza cavo alimentazione (mm)	1500 mm
N° of wands   N° ugelli	2
Warranty   Garanzia	2 years   2 anni

Degree of Protection: IP 24 | Grado di protezione: IP 24

## FUNCTIONS funzioni

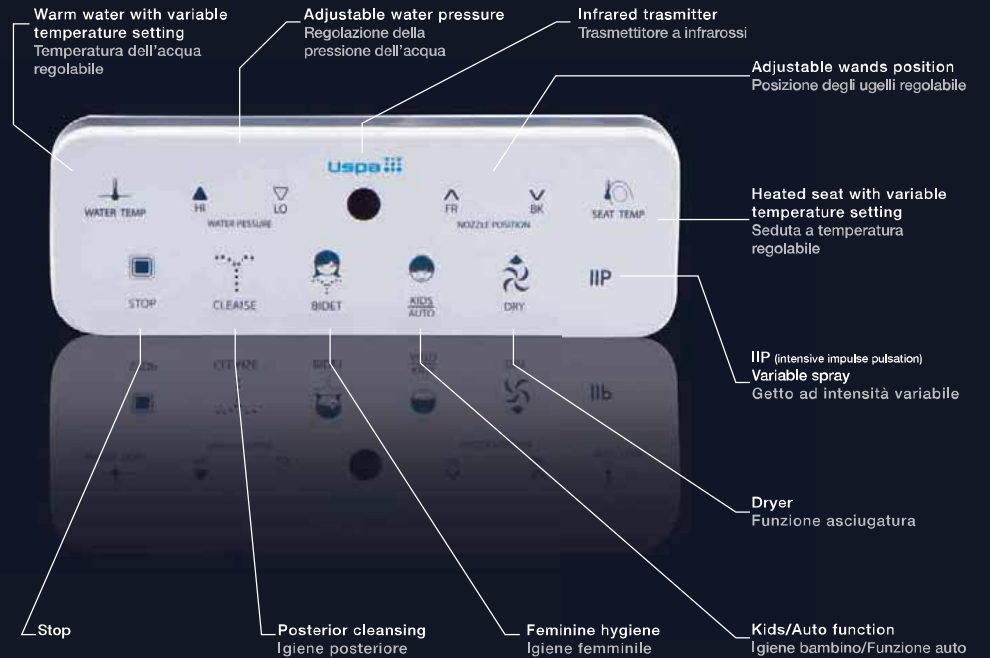

EN 1717







Uspa   
7235



<b>7235S</b>	Li 460 - Pi 490 - Hi 157 Dimensions (mm)   Dimensioni (mm)	4.4 Kg Net weight   Peso netto	460 mm	490 mm	157 mm
<b>7235</b>	Li 458 - Pi 520 - Hi 157 Dimensions (mm)   Dimensioni (mm)	4.4 Kg Net weight   Peso netto	458 mm	520 mm	157 mm
<b>7235U</b>	Li 457 - Pi 504 - Hi 157 Dimensions (mm)   Dimensioni (mm)	4.4 Kg Net weight   Peso netto	457 mm	504 mm	157 mm

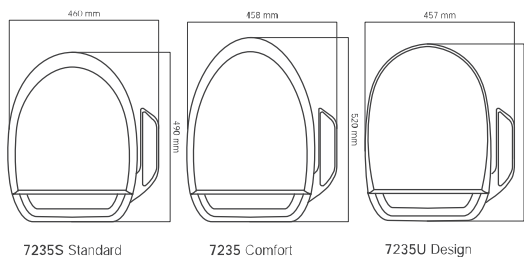

#### Technical details | Caratteristiche tecniche 7235S - 7235 - 7235U

Personalized controls   Controllo funzioni	Control panel   Pannello di controllo	
Power supply   Alimentazione	AC 220 - 240 V 50 Hz	
Maximum power consumption   Consumo elettrico massimo	1660 - 1975 W	
Tap water pressure   Pressione mandata acqua	0.50 - 7.40 Atm	
Heated seat   Sedile riscaldato	Temperature   Temperatura	Adjustable (3 levels) / 34 °C - 40 °C   3 livelli di regolazione / 34 °C - 40 °C
	Safety device   Dispositivo di sicurezza	Temp. fuse   Fusibile termico
	Power consumption   Consumo elettrico	55 - 65 W
Hygiene   Igiene	Temperature   Temperatura	Adjustable (3 levels) / 34 °C - 40 °C   3 livelli di regolazione / 34 °C - 40 °C
	Water spray   Intensità getto	Adjustable (5 levels - max 750 ml/min)   5 livelli di regolazione (max 750 ml/min)
	Safety devices   Dispositivi di sicurezza	Temp. fuse   Fusibile termico Thermal switch   Interruttore termico Floating switch   Interruttore a galleggiante
	Power consumption   Consumo elettrico	1600 - 1905 W
Air dryer   Asciugatura	Temperature   Temperatura	Adjustable (5 levels)   5 livelli di regolazione
	Safety device   Dispositivo di sicurezza	Temp. fuse   Fusibile termico
	Power consumption   Consumo elettrico	280 - 333 W
Electricity safety protection   Dispositivo di sicurezza elettrica	15 mA - GFCI	
Power cord length (mm)   Lunghezza cavo alimentazione (mm)	1500 mm	
N° of wands   N° ugelli	2	
Warranty   Garanzia	2 Years   2 Anni	

Degree of Protection: IP 24 | Grado di protezione IP 24

## FUNCTIONS funzioni



EN 1717







Uspa  
**7000**

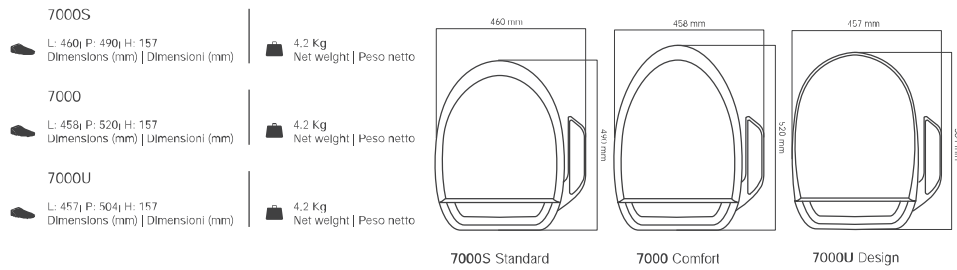

**Technical details | Caratteristiche tecniche**  
7000S - 7000 - 7000U

Personalized controls   Controllo funzioni	Control panel   Pannello di controllo
Power supply   Alimentazione	AC 220 - 240 V 50 Hz
Maximum power consumption   Consumo elettrico massimo	1605 - 1910 W
Tap water pressure   Pressione mandata acqua	0.50 - 7.40 Atm
Hygiene   Igiene	Temperature   Temperatura Adjustable (3 levels) / 34 °C - 40 °C   3 livelli di regolazione / 34 °C - 40 °C
	Waterspray   Intensità getto Adjustable (5 levels - max 750 ml/min)   5 livelli di regolazione (max 750 ml/min)
	Safety devices   Dispositivi di sicurezza Temp. fuse   Fusibile termico Thermal switch   Interruttore termico Floating switch   Interruttore a galleggiante
	Power consumption   Consumo elettrico 1600 W
Electricity safety protection   Dispositivo di sicurezza elettrica	15 mA - GFCI
Power cord length (mm)   Lunghezza cavo alimentazione (mm)	1500 mm
N° of wands   N° ugelli	2
Warranty   Garanzia	2 Years   2 Anni

Degree of Protection IP 24 | Grado di protezione IP 24

# FUNCTIONS funzioni



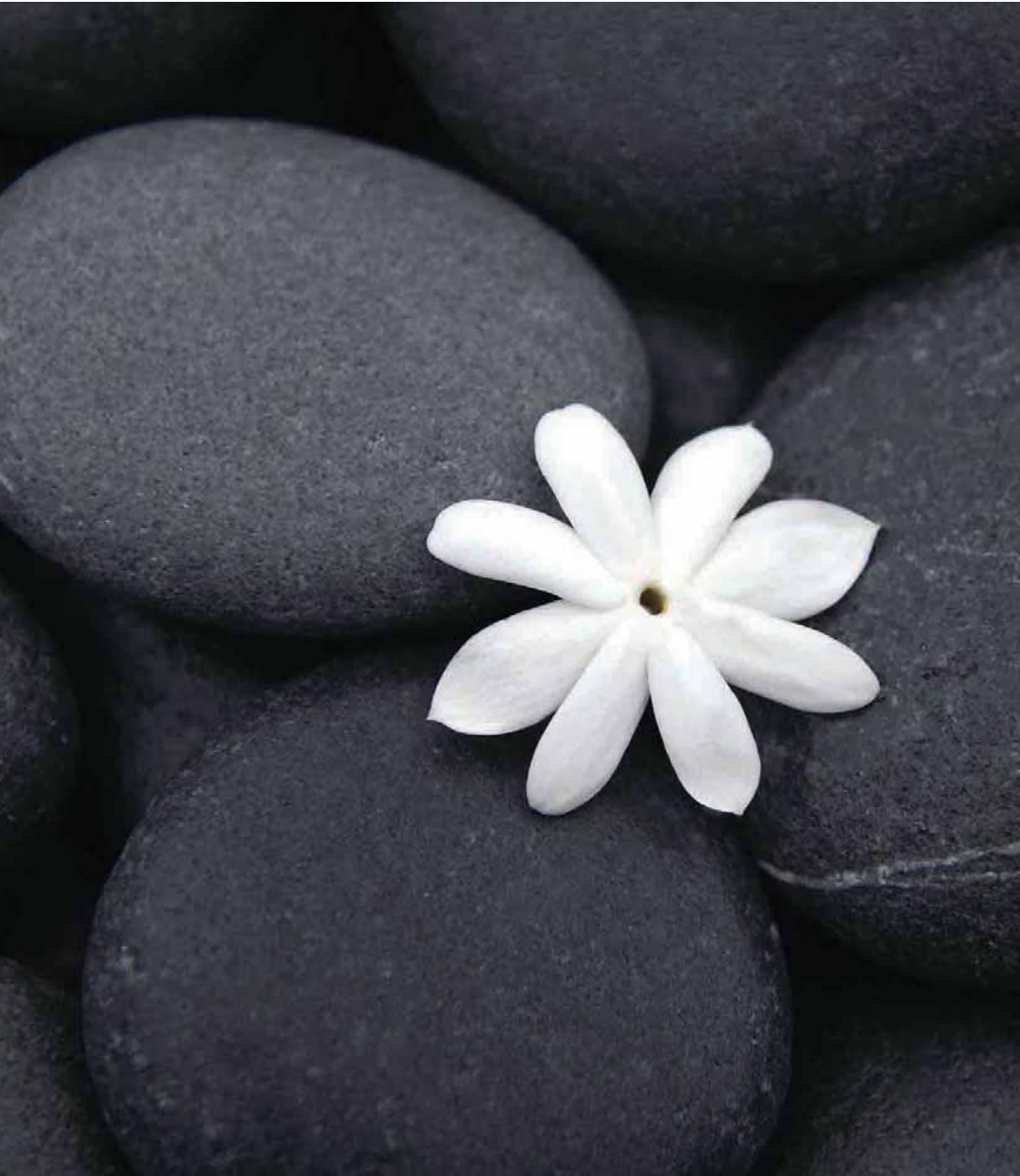

# USPA: YOUR DAILY SPA

USPA: LA TUA SPA QUOTIDIANA



# MAIN FEATURES

CARATTERISTICHE PRINCIPALI

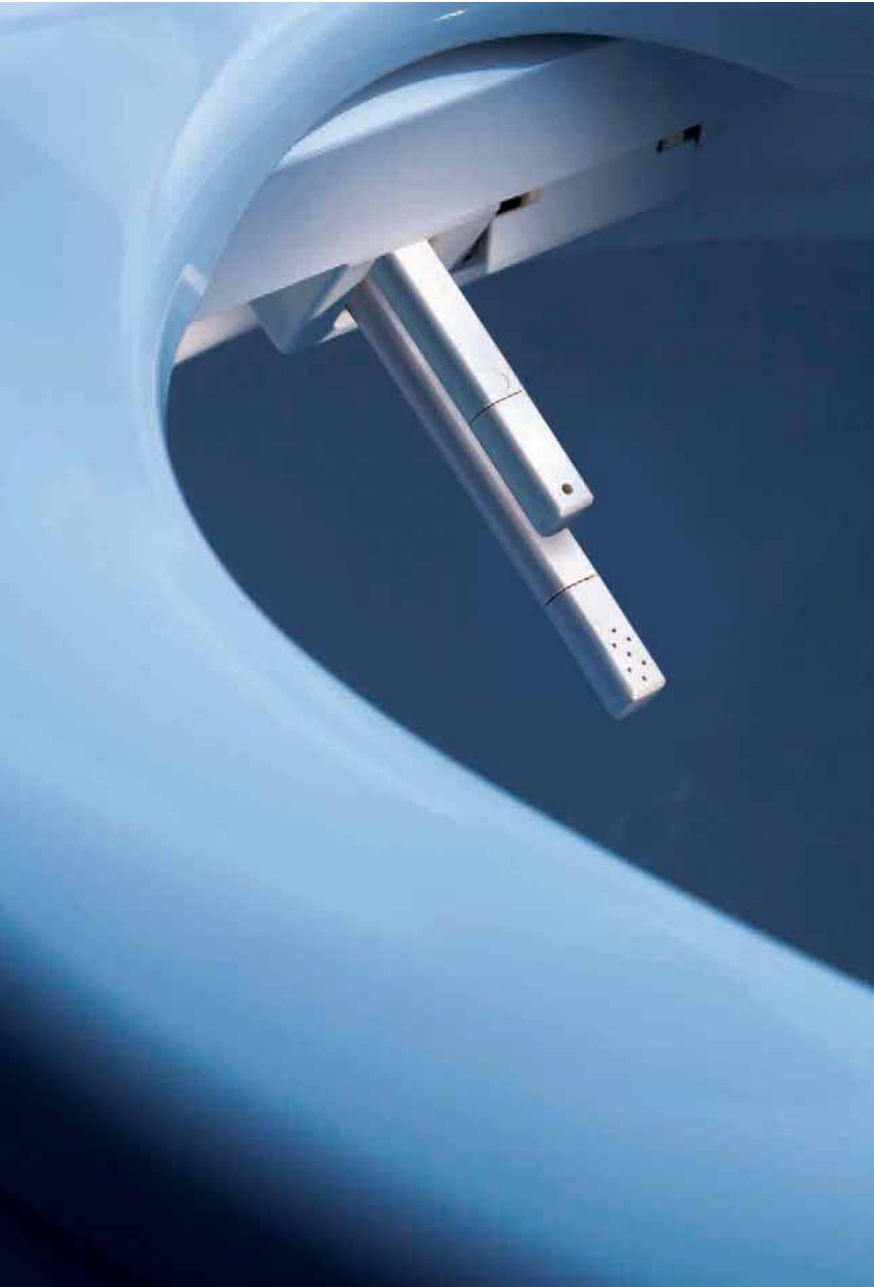

-  Posterior cleansing  
Igiene posteriore
-  Feminine cleansing  
Igiene femminile
-  "Kids" function  
Igiene bambini
-  Aerated spray  
Getto aerato
-  "IP" function  
Funzione "IP"
-  Variable spray  
Getto ad intensità variabile
-  Position of wands variable  
Posizione degli ugelli regolabile
-  Automatic cleansing of the wands  
Pulizia automatica degli ugelli

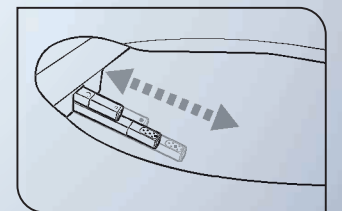



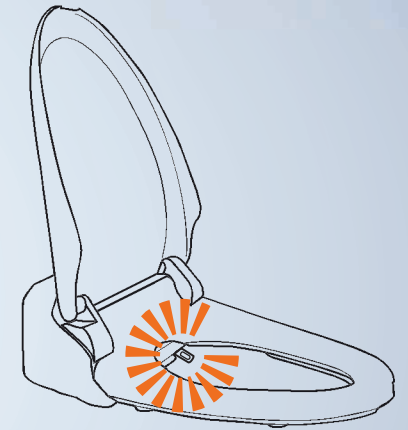
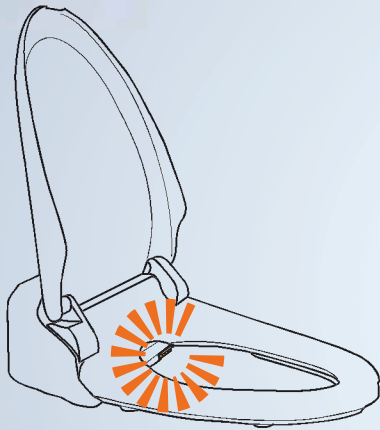



HEATED SEAT  
SEDILE RISCALDATO

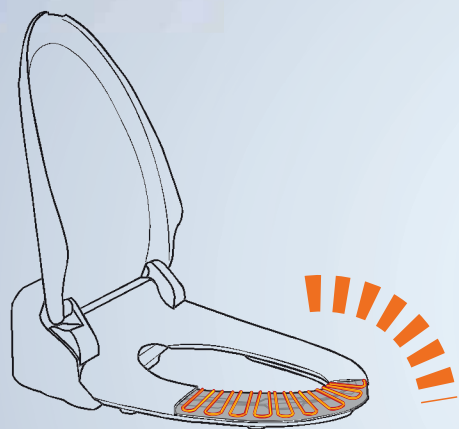

Uspa

SOFT CLOSING  
CHIUSURA DOLCE

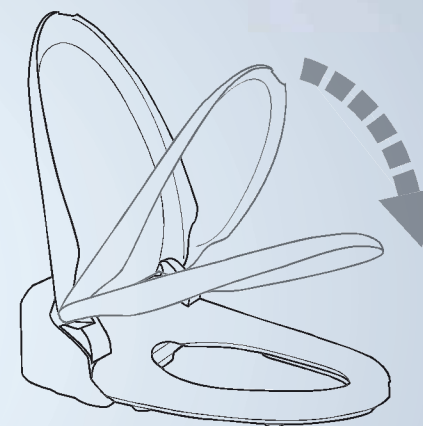



DEODORIZER  
DEODORIZZATORE

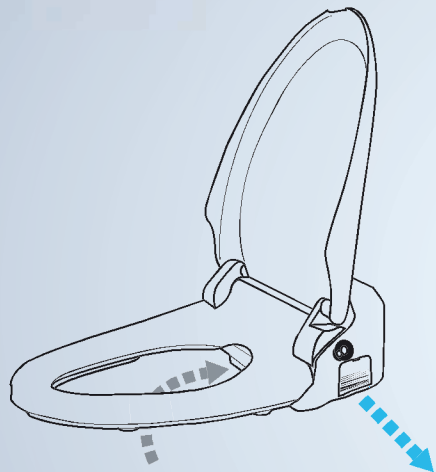

-  Posterior cleansing  
Igiene posteriore
-  Feminine cleansing  
Igiene femminile
-  "Kids" function  
Igiene bambini
-  Aerated spray  
Getto aerato
-  "IP" function  
Funzione "IP"
-  Variable spray  
Getto ad intensità variabile
-  Automatic cleansing of the wands  
Pulizia automatica degli ugelli
-  Position of wands variable  
Posizione degli ugelli regolabile
-  Heated seat with variable temperature setting  
Seduta riscaldata con temperatura regolabile
-  Warm water with variable temperature setting  
Temperatura dell'acqua regolabile
-  "Auto" function (hygiene + dryer)  
Funzione "Auto" (Igiene + asciugatura)
-  Soft closing  
Chiusura dolce
-  Remote control  
Telecomando
-  Control panel  
Pannello di controllo
-  Touch activated on/off sensor  
Sensore di accensione a sfioramento
-  Made from germ-resistant plastic  
Materiale plastico antibatterico
-  Easy installation / Adaptable to most standard fixtures  
Facile installazione / Elevata adattabilità
-  Energy saving function  
Funzione di risparmio energetico
-  11 safety devices  
11 dispositivi di sicurezza
-  Complies with EN 1717 European regulations  
Conforme alla norma europea EN 1717



FEATURES   CARATTERISTICHE	USPA 6035R	USPA 7035R
Material   Materiale	ABS	
Gentle closing seat and lid   Chiusura dolce della seduta e del coperchio	●	●
Posterior cleansing   Igiene posteriore	●	●
Feminine cleansing   Igiene femminile	●	●
Variable spray   Intensità del getto regolabile	●	●
Aerated spray   Getto aerato	●	-
Intensive Impulse Pulsation function   Funzione IIP	●	●
Kids function   Funzione Kids (Bambini)	●	●
"Auto" function (hygiene + dryer)   Funzione "Auto" (igiene + asciugatura)	●	●
N° of wands   N° ugelli	2 Adjustable   2 Regolabili	2 Adjustable   2 Regolabili
Position of wands variable   Posizione degli ugelli regolabile	5 Levels   5 Livelli	5 Levels   5 Livelli
Warm water with variable temperature setting   Temperatura dell'acqua regolabile	3 Levels   3 Livelli	3 Levels   3 Livelli
Water heater   Riscaldamento dell'acqua	Continuous   Continuo	Continuous   Continuo
Heated seat with variable temperature setting   Seduta riscaldata con temperatura regolabile	3 Levels   3 Livelli	3 Levels   3 Livelli
Warm air dryer with variable temperature setting   Asciugatura con temp. dell'aria regolabile	5 Levels - 2 Intensities   5 Livelli - 2 Intensità	5 Levels - 2 Intensities   5 Livelli - 2 Intensità
Dryer   Tipologia di asciugatura	Infrared   Infrarossi	Adjustable wand   Ugello regolabile
Deodorizer   Deodorizzatore	●	●
Energy saving function   Funzione di risparmio Energetico	Intelligent   Intelligente	Intelligent   Intelligente
On/off sensor   Sensore di accensione	Touch activated   Sforamento	Touch activated   Sforamento
Personalized controls   Controllo funzioni	Remote Control   Telecomando	Remote Control   Telecomando
Automatic cleansing of the wands   Pulizia automatica degli ugelli	●	●
Self check   Self Diagnosi	●	●
Side mounted supplementary buttons   Tasti ausiliari	●	●
Easy installation   Installazione	Less than one hour   Mediamente meno di un'ora	
Warranty   Garanzia	2 Years   2 Anni	

USPA 6235	USPA 6210	USPA 7235	USPA 7000
ABS			
●	●	●	●
●	●	●	●
●	●	●	●
●	●	●	●
●	●	-	-
●	●	●	-
●	●	●	-
●	Hygiene only   Solo igiene	●	-
2 Adjustable   2 Regolabili	2 Adjustable   2 Regolabili	2 Adjustable   2 Regolabili	2 Adjustable   2 Regolabili
5 Levels   5 Livelli	5 Levels   5 Livelli	5 Levels   5 Livelli	5 Levels   5 Livelli
3 Levels   3 Livelli	3 Levels   3 Livelli	3 Levels   3 Livelli	3 Levels   3 Livelli
Continuous   Continuo	Continuous   Continuo	Continuous   Continuo	Continuous   Continuo
3 Levels   3 Livelli	3 Levels   3 Livelli	3 Levels   3 Livelli	-
5 Levels - 2 Intensities   5 Livelli - 2 Intensità	-	5 Levels - 2 Intensities   5 Livelli - 2 Intensità	-
Infrared   Infrarossi	-	Adjustable wand   Ugello regolabile	-
●	-	●	-
Intelligent   Intelligente	Intelligent   Intelligente	Intelligent   Intelligente	Intelligent   Intelligente
Touch activated   Sforamento	Touch activated   Sforamento	Touch activated   Sforamento	Touch activated   Sforamento
Control Panel   Pannello	Control Panel   Pannello	Control Panel   Pannello	Control Panel   Pannello
●	●	●	●
●	●	●	●
-	-	-	-
Less than one hour   Mediamente meno di un'ora			
2 Years   2 Anni			

# ECOLOGICAL BIDET

BIDET ECOLOGICO



Uspa   
M400





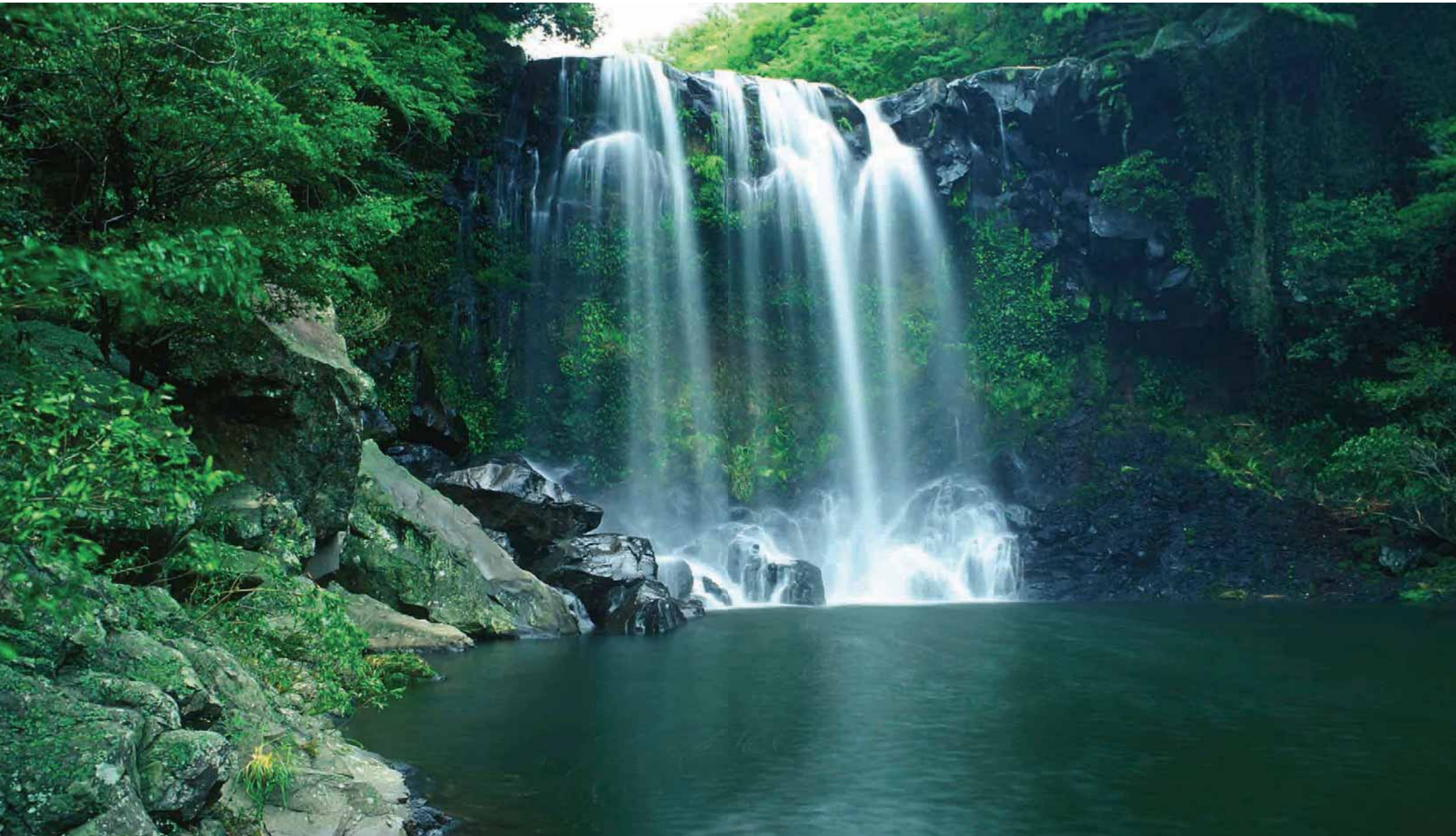

<b>M400S</b>	Li 462· Pi 490· Ht 144 Dimensions (mm)   Dimensioni (mm)	2.7 Kg Net weight   Peso netto
<b>M400</b>	Li 460· Pi 520· Ht 144 Dimensions (mm)   Dimensioni (mm)	2.7 Kg Net weight   Peso netto
<b>M400U</b>	Li 458· Pi 504· Ht 144 Dimensions (mm)   Dimensioni (mm)	2.7 Kg Net weight   Peso netto

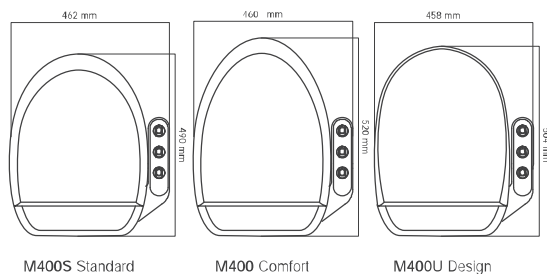

#### Technical details | Caratteristiche tecniche M400S - M400 - M400U

Personalized controls   Controllo funzioni	Control panel   Pannello di controllo
Tap water pressure   Pressione mandata acqua	0.50 - 4.80 Atm
N° of wands   N° ugelli	2
Warranty   Garanzia	2 Years   2 Anni

- Hot water connection / Attacco idrico acqua calda
- Cold water connection / Attacco idrico acqua fredda

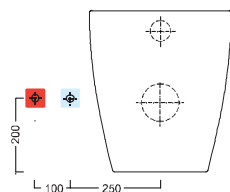

#### Recommended connections per USPA eco bidet M400

Warning: the drawing shows the WC from the front side.  
The water supply lines should be placed on the left.  
For a better comfort, it is advisable to connect the M400 both to the cold and hot water supply lines.  
It's absolutely forbidden to connect the M400 model to the hot water supply line only, while it can be connected to the cold water supply line only.  
The connection to the cold and hot water outlets by a stopcock is strongly recommended.

#### Collegamenti consigliati per il modello USPA M400

Attenzione: l'immagine mostra il prodotto visto di fronte.  
E' preferibile prevedere gli attacchi idraulici a sinistra.  
Per un comfort maggiore, è consigliabile collegare il sedile M400 sia all'impianto di acqua fredda che a quello di acqua calda.  
E' assolutamente vietato collegare il sedile solamente all'impianto di acqua calda, mentre è possibile collegarlo solo all'impianto dell'acqua fredda.  
E' vivamente consigliato collegare il modello M400 all'impianto idrico mediante uno/due rubinetto/i d'arresto.

## FUNCTIONS funzioni

Posterior cleansing  
Igiene posteriore

Cleansing of the nozzles  
Pulizia degli ugelli

Feminine hygiene  
Igiene femminile

Adjustable water pressure  
Regolazione della  
pressione dell'acqua

Warm water with variable  
temperature setting  
Temperatura dell'acqua  
regolabile







**JUST  
WATER  
NO  
ELECTRICITY**



Uspa 



**THE**  
*harmony*  
of design  
the new shape  
**OF HYGIENE**





SHAPES   FORME	USPA M400	USPA 6035R	USPA 7035R
STANDARD	●	●	●
COMFORT	●	●	●
DESIGN	●	●	●



	USPA 6235	USPA 6210	USPA 7235	USPA 7000
	●	●	●	●
	●	●	●	●
	-	-	●	●

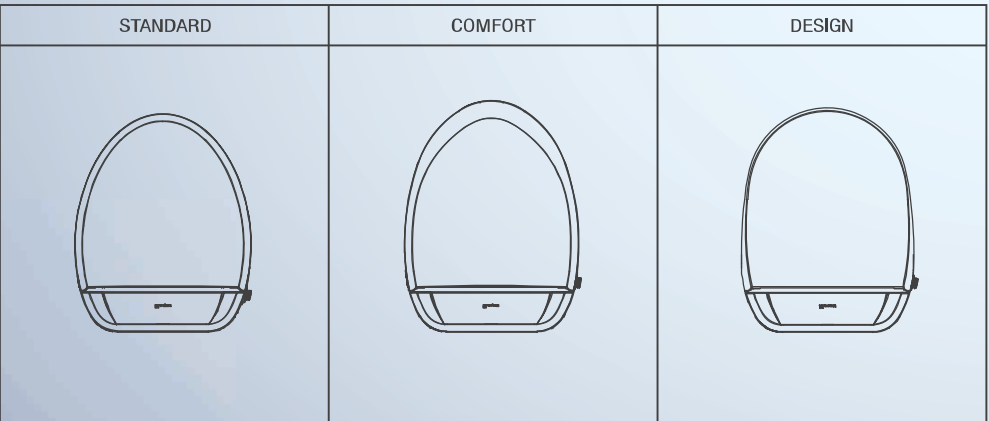

SIZES   DIMENSIONI	STANDARD	COMFORT	DESIGN
A	430 - 455 mm	455 - 490 mm	430 - 470 mm
B	Over 40 mm   Superiore a 40 mm		
C	140 - 240 mm		

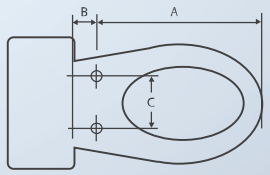

CHOOSE THE QUALITY  
OF OUR WCs  
MADE TO MATCH  
COMFORT  
AND DESIGN SHAPES

SCEGLI LA QUALITÀ DEI NOSTRI WC  
CREATI PER LE LINEE COMFORT E DESIGN

# USPA COMFORT + WC

Velis 57 Floor | Terra



Velis 57 Wall-Hung | Sospeso



Solo Wall-Hung | Sospeso



Duo Floor | Terra



# USPA COMFORT + SOLO

PRODUCT CODE / CODICE PRODOTTO  
**NWCSS02**

SIZE (mm) / DIMENSIONI (mm)  
**L: 380 P: 570**

COLOR / COLORE  
**White / Bianco**

TPOLOGY / TIPOLOGIA  
**Wall-hung WC (6,0 l. flush) / WC Sospeso (scarico 6,0 l.)**





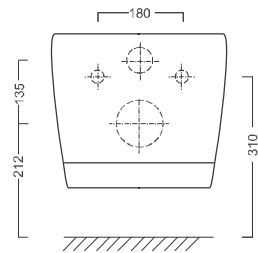
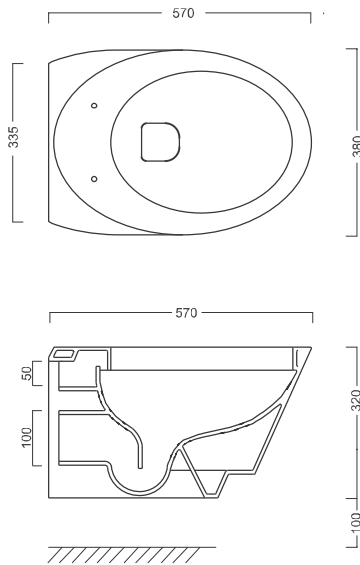

NWCSS02  
Solo

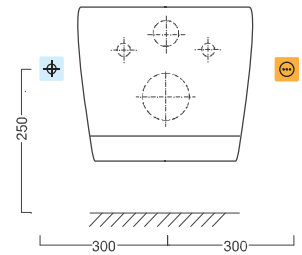

Option A | Opzione A



-  Electrical outlet / Presa elettrica
-  Cold water connection / Attacco idrico

Option B | Opzione B

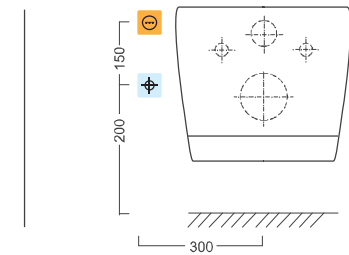

**Recommended connections**  
for USPA electronic bidets

Warning: the drawings show the WC from the front side.

The electrical outlet can be equally placed on both sides, while the cold water connection, from the front view to the product, should be placed on the **left side** of the toilet bowl.

The connection to the cold water outlet by a stopcock is strongly recommended.

**Collegamenti consigliati**  
per i bidet elettronici USPA

Attenzione: i disegni tecnici mostrano il WC visto di fronte.

La presa elettrica può essere installata indifferentemente su ambo i lati, mentre l'attacco idrico, guardando il vaso, dovrebbe risultare alla sua sinistra.

E' consigliato il collegamento idrico mediante rubinetto.

# USPA COMFORT + DUO

PRODUCT CODE / CODICE PRODOTTO  
**NWCDT03**

SIZE (mm) / DIMENSIONI (mm)  
**L: 375 P: 525**

COLOR / COLORE  
**White / Bianco**

TYPOLOGY / TIPOLOGIA  
**Floor WC (4,5 l. flush) / WC Terra (scarico 4,5 l.)**



NWCDT03  
Duo

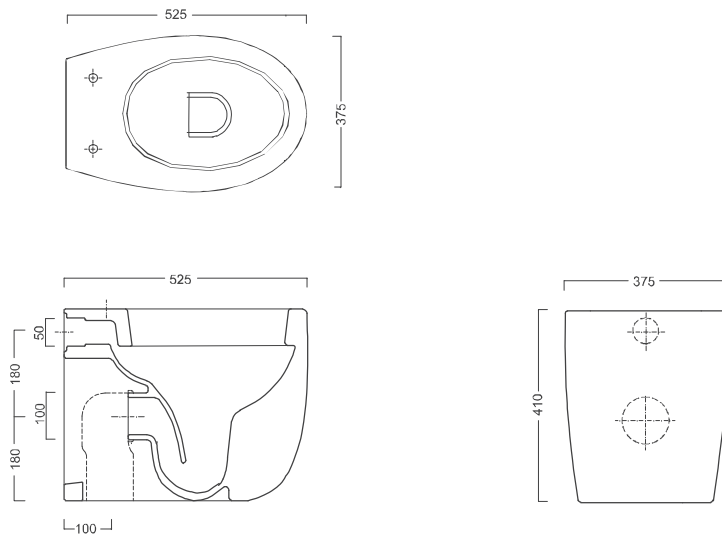

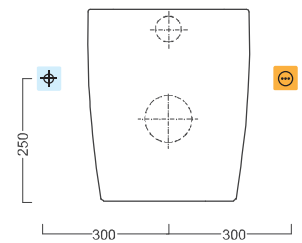

Option A | Opzione A

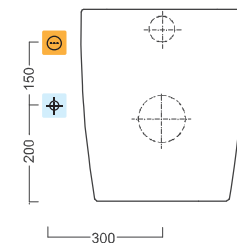

Option B | Opzione B



-  Electrical outlet / Presa elettrica
-  Cold water connection / Attacco idrico

**Recommended connections**  
for USPA electronic bidets

Warning: the drawings show the WC from the front side.

The electrical outlet can be equally placed on both sides, while the cold water connection, from the front view to the product, should be placed on the left side of the toilet bowl.

The connection to the cold water outlet by a stopcock is strongly recommended.

**Collegamenti consigliati**  
per i bidet elettronici USPA

Attenzione: i disegni tecnici mostrano il WC visto di fronte.

La presa elettrica può essere installata indifferentemente su ambo i lati, mentre l'attacco idrico, guardando il vaso, dovrebbe risultare alla sua sinistra.

E' consigliato il collegamento idrico mediante rubinetto.

# USPA COMFORT + VELIS 57

## WALL-HUNG | SOSPESO

PRODUCT CODE / CODICE PRODOTTO  
**CWCVS04**

SIZE (mm) / DIMENSIONI (mm)  
**L: 370 P: 570**

COLOR / COLORE  
**White / Bianco**

TYPOLOGY / TIPOLOGIA  
**Wall-hung WC (4,5 l. flush) / WC Sospeso (scarico 4,5 l.)**





CWCVS04

## Velis 57 Wall-hung | Velis 57 Sospeso

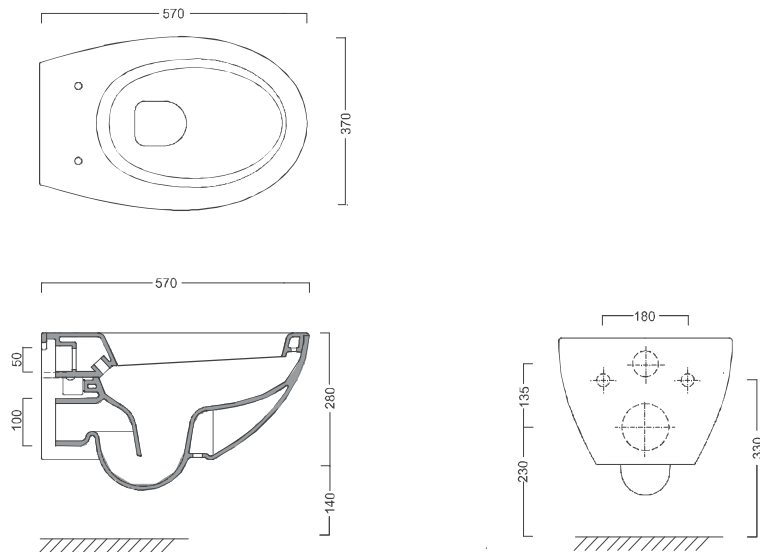

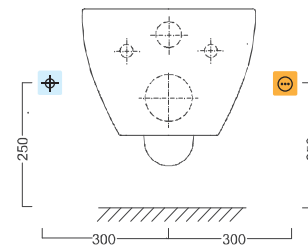

\* To be installed only on M12 bars | Installazione solo su barre M12

### Option A | Opzione A

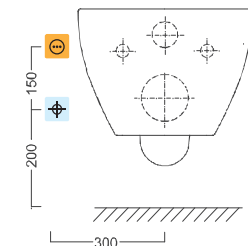

### Option B | Opzione B



-  Electrical outlet / Presa elettrica
-  Cold water connection / Attacco idrico

### Recommended connections for USPA electronic bidets

Warning: the drawings show the WC from the front side.

The electrical outlet can be equally placed on both sides, while the cold water connection, from the front view to the product, should be placed on the left side of the toilet bowl.

The connection to the cold water outlet by a stopcock is strongly recommended.

### Collegamenti consigliati per i bidet elettronici USPA

Attenzione: i disegni tecnici mostrano il WC visto di fronte.

La presa elettrica può essere installata indifferentemente su ambo i lati, mentre l'attacco idrico, guardando il vaso, dovrebbe risultare alla sua sinistra.

E' consigliato il collegamento idrico mediante rubinetto.

# USPA COMFORT + VELIS 57 FLOOR | TERRA

PRODUCT CODE / CODICE PRODOTTO  
**CWCVT05**

SIZE (mm) / DIMENSIONI (mm)  
**L: 370 P: 570**

COLOR / COLORE  
**White / Bianco**

TPOLOGY / TIPOLOGIA  
**Floor WC (4,5 l. flush) / WC Terra (scarico 4,5 l.)**



CWCVT05  
**Velis 57 Floor | Velis 57 Terra**

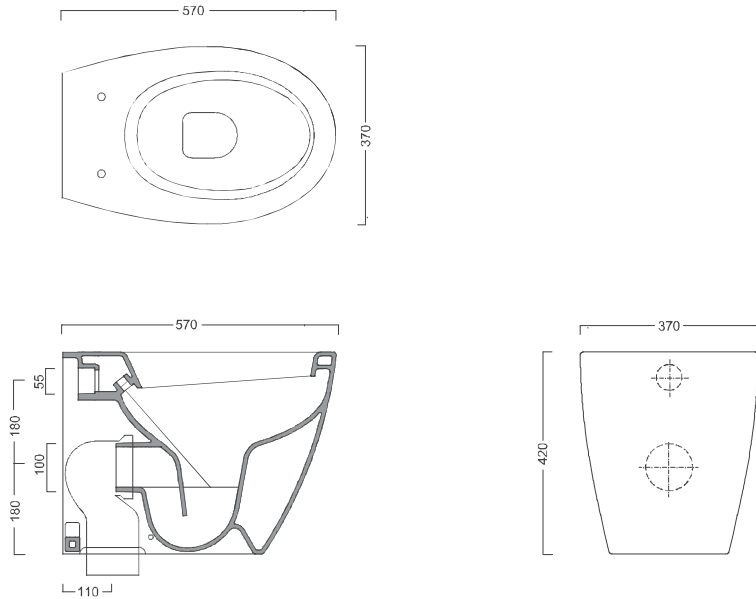

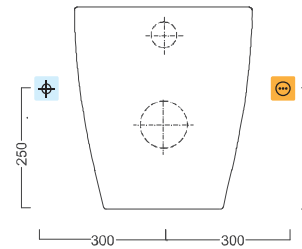

**Option A | Opzione A**

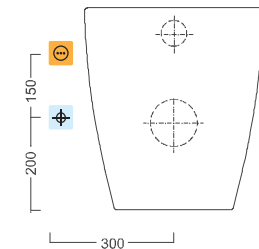

**Option B | Opzione B**



-  Electrical outlet / Presa elettrica
-  Cold water connection / Attacco idrico

**Recommended connections**  
for USPA electronic bidets

Warning: the drawings show the WC from the front side.

The electrical outlet can be equally placed on both sides, while the cold water connection, from the front view to the product, should be placed on the **left** side of the toilet bowl.

The connection to the cold water outlet by a stopcock is strongly recommended.

**Collegamenti consigliati**  
per i bidet elettronici USPA

Attenzione: i disegni tecnici mostrano il WC visto di fronte.

La presa elettrica può essere installata indifferentemente su ambo i lati, mentre l'attacco idrico, guardando il vaso, dovrebbe risultare alla sua sinistra.

E' consigliato il collegamento idrico mediante rubinetto.

▼ Velis 57 Floor | Terra



▼ Velis 57 Wall-Hung | Sospeso



▲ Duo Floor | Terra

▶ Solo Wall-Hung | Sospeso







**KOREAN  
TECHNOLOGY  
ITALIAN  
DESIGN**

# USPA DESIGN + WC

Sfera floor | Terra



Sfera Wall-Hung | Sospeso



Zero Wall-Hung | Sospeso



Zero floor | Terra



# USPA DESIGN + ZERO

## WALL-HUNG | SOSPESO

PRODUCT CODE / CODICE PRODOTTO  
**CWCZS06**

SIZE (mm) / DIMENSIONI (mm)  
**L: 350 P: 550**

COLOR / COLORE  
**White / Bianco**

TIPOLOGY / TIPOLOGIA  
**Wall-hung WC (4,5 l. flush) / WC Sospeso (scarico 4,5 l.)**



CWCZS06  
Zero Wall-hung | Zero Sospeso

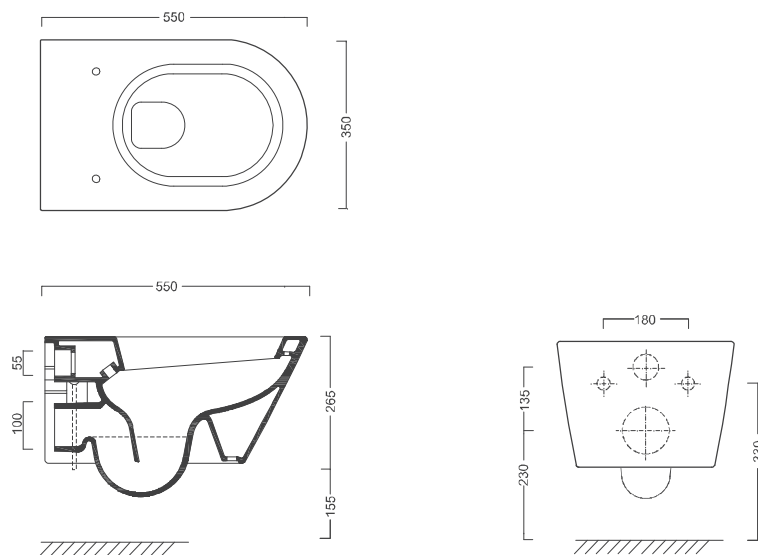

\* To be installed only on M12 bars | Installazione solo su barre M12

Option A | Opzione A

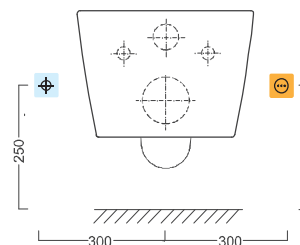

-  Electrical outlet / Presa elettrica
-  Cold water connection / Attacco idrico

Option B | Opzione B

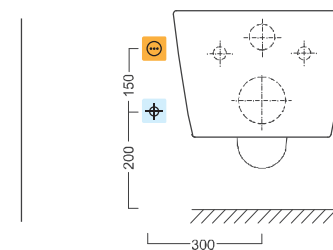

**Recommended connections**  
for USPA electronic bidets

Warning: the drawings show the WC from the front side.

The electrical outlet can be equally placed on both sides, while the cold water connection, from the front view to the product, should be placed on the left side of the toilet bowl.

The connection to the cold water outlet by a stopcock is strongly recommended.

**Collegamenti consigliati**  
per i bidet elettronici USPA

Attenzione: i disegni tecnici mostrano il WC visto di fronte.

La presa elettrica può essere installata indifferentemente su ambo i lati, mentre l'attacco idrico, guardando il vaso, dovrebbe risultare alla sua sinistra.

E' consigliato il collegamento idrico mediante rubinetto.



**USPA DESIGN + ZERO**  
FLOOR | TERRA

PRODUCT CODE / CODICE PRODOTTO  
**CWCZT07**

SIZE (mm) / DIMENSIONI (mm)  
**L: 350 P: 550**

COLOR / COLORE  
**White / Bianco**

TIPOLOGY / TIPOLOGIA  
**Floor WC (4,5 l. flush) / WC Terra (scarico 4,5 l.)**



CWCZT07  
Zero Floor | Zero Terra

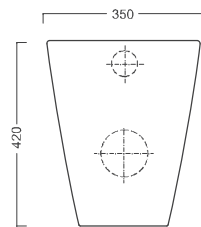
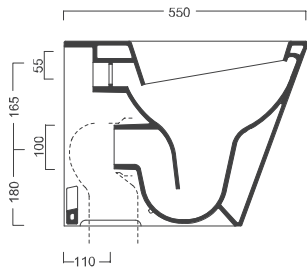
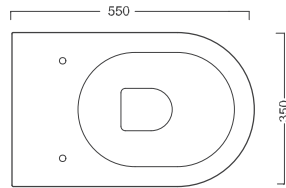

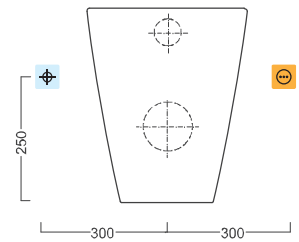

Option A | Opzione A

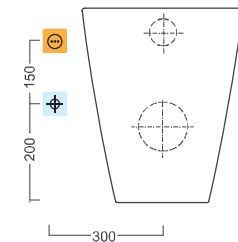

Option B | Opzione B



-  Electrical outlet / Presa elettrica
-  Cold water connection / Attacco idrico

**Recommended connections  
for USPA electronic bidets**

Warning: the drawings show the WC from the front side.

The electrical outlet can be equally placed on both sides, while the cold water connection, from the front view to the product, should be placed on the left side of the toilet bowl.

The connection to the cold water outlet by a stopcock is strongly recommended.

**Collegamenti consigliati  
per i bidet elettronici USPA**

Attenzione: i disegni tecnici mostrano il WC visto di fronte.

La presa elettrica può essere installata indifferentemente su ambo i lati, mentre l'attacco idrico, guardando il vaso, dovrebbe risultare alla sua sinistra.

E' consigliato il collegamento idrico mediante rubinetto.

# USPA DESIGN + SFERA WALL-HUNG | SOSPESO

PRODUCT CODE / CODICE PRODOTTO  
**CWCSS08**

SIZE (mm) / DIMENSIONI (mm)  
**L: 350 P: 540**

COLOR / COLORE  
**White / Bianco**

TPOLOGY / TIPOLOGIA  
**Wall-hung WC (4,5 l. flush) / WC Sospeso (scarico 4,5 l.)**



CWCSS08

## Sfera Wall-hung | Sfera Sospeso

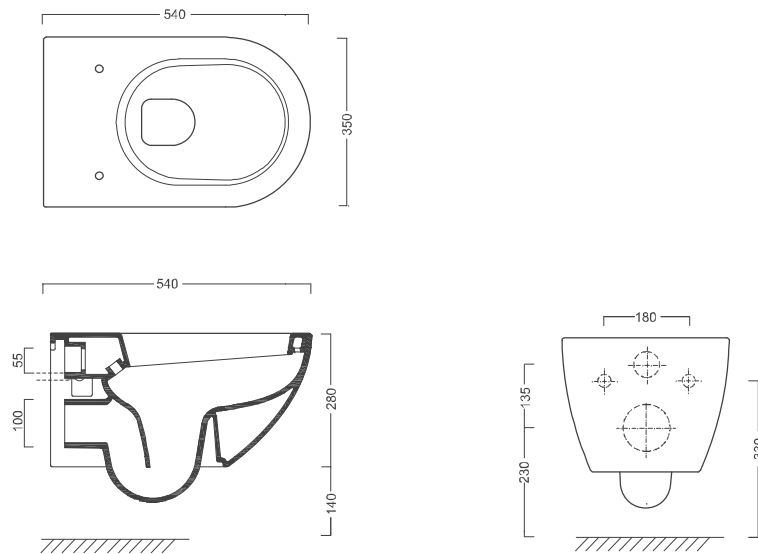

\* To be installed only on M12 bars | Installazione solo su barre M12

### Option A | Opzione A

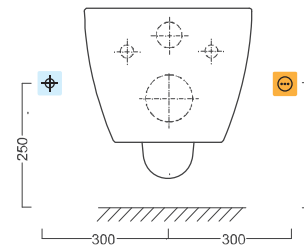

- ⚡ Electrical outlet / Presa elettrica
- ⚡ Cold water connection / Attacco idrico

### Option B | Opzione B

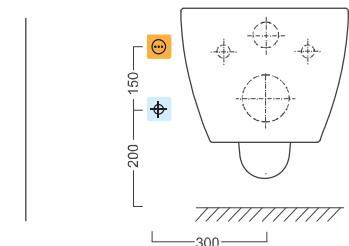

### Recommended connections for USPA electronic bidets

Warning: the drawings show the WC from the front side.

The electrical outlet can be equally placed on both sides, while the cold water connection, from the front view to the product, should be placed on the left side of the toilet bowl.

The connection to the cold water outlet by a stopcock is strongly recommended.

### Collegamenti consigliati per i bidet elettronici USPA

Attenzione: i disegni tecnici mostrano il WC visto di fronte.

La presa elettrica può essere installata indifferentemente su ambo i lati, mentre l'attacco idrico, guardando il vaso, dovrebbe risultare alla sua sinistra.

E' consigliato il collegamento idrico mediante rubinetto.



# USPA DESIGN + SFERA

## FLOOR | TERRA

PRODUCT CODE / CODICE PRODOTTO  
**CWCST09**

SIZE (mm) / DIMENSIONI (mm)  
**L: 350 P: 540**

COLOR / COLORE  
**White / Bianco**

TIPOLOGY / TIPOLOGIA  
**Floor WC (4,5 l. flush) / WC Terra (scarico 4,5 l.)**



CWCST09  
Sfera Floor | Sfera Terra

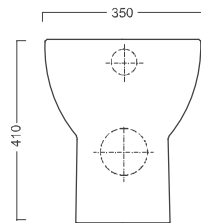
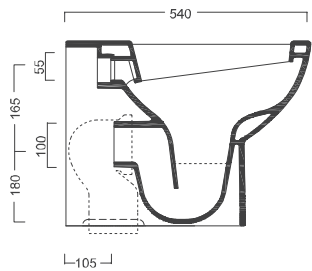
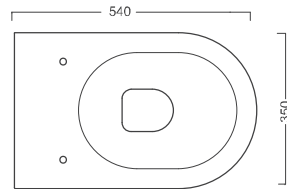

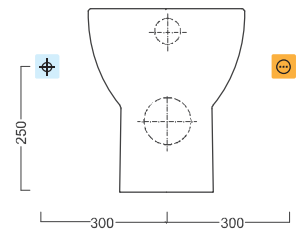

Option A | Opzione A

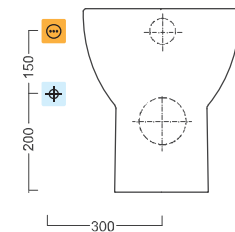

Option B | Opzione B



-  Electrical outlet / Presa elettrica
-  Cold water connection / Attacco idrico

**Recommended connections**  
for USPA electronic bidets

Warning: the drawings show the WC from the front side.

The electrical outlet can be equally placed on both sides, while the cold water connection, from the front view to the product, should be placed on the left side of the toilet bowl.

The connection to the cold water outlet by a stopcock is strongly recommended.

**Collegamenti consigliati**  
per i bidet elettronici USPA

Attenzione: i disegni tecnici mostrano il WC visto di fronte.

La presa elettrica può essere installata indifferentemente su ambo i lati, mentre l'attacco idrico, guardando il vaso, dovrebbe risultare alla sua sinistra.

E' consigliato il collegamento idrico mediante rubinetto.

▼ Sfera Floor | Terra



▼ Sfera Wall-Hung | Sospeso



▲ Zero Wall-Hung | Sospeso

▶ Zero Floor | Terra







# ACCESSORIES

ACCESSORI

# ACCESSORIES | ACCESSORI

## STOPCOCK | RUBINETTO D'ARRESTO

PRODUCT CODE / CODICE PRODOTTO  
**NLRAL01**

Polished stainless steel | Acciaio lucido

3/8" stopcock with filter and adaptor (3/8" - 1/2")  
Rubinetto di regolazione 3/8" con filtro e adattatore (3/8" - 1/2")

PRODUCT CODE / CODICE PRODOTTO  
**NLRAS02**

Brushed stainless steel | Acciaio satinato

3/8" stopcock with filter and adaptor (3/8" - 1/2")  
Rubinetto di regolazione 3/8" con filtro e adattatore (3/8" - 1/2")



# USPA BIDET DETAILS

DETTAGLI BIDET USPA



6035RS

Code | Codice  
UB-6035RS  
Shape | Forma  
Standard  
Colour | Colore  
White | Bianco



6035R

Code | Codice  
UB-6035R  
Shape | Forma  
Comfort  
Colour | Colore  
White | Bianco



6035RU

Code | Codice  
UB-6035RU  
Shape | Forma  
Design  
Colour | Colore  
White | Bianco



6235S

Code | Codice  
UB-6235S  
Shape | Forma  
Standard  
Colour | Colore  
White | Bianco



6235

Code | Codice  
UB-6235  
Shape | Forma  
Comfort  
Colour | Colore  
White | Bianco



6210S

Code | Codice  
UB-6210S  
Shape | Forma  
Standard  
Colour | Colore  
White | Bianco



6210

Code | Codice  
UB-6210  
Shape | Forma  
Comfort  
Colour | Colore  
White | Bianco





7035RS

Code | Codice  
UB-7035RS  
Shape | Forma  
Standard  
Colour | Colore  
White | Bianco



7035R

Code | Codice  
UB-7035R  
Shape | Forma  
Comfort  
Colour | Colore  
White | Bianco



7035RU

Code | Codice  
UB-7035RU  
Shape | Forma  
Design  
Colour | Colore  
White | Bianco



7235S

Code | Codice  
UB-7235S  
Shape | Forma  
Standard  
Colour | Colore  
White | Bianco



7235

Code | Codice  
UB-7235  
Shape | Forma  
Comfort  
Colour | Colore  
White | Bianco



7235U

Code | Codice  
UB-7235U  
Shape | Forma  
Design  
Colour | Colore  
White | Bianco



7000S

Code | Codice  
UB-7000S  
Shape | Forma  
Standard  
Colour | Colore  
White | Bianco



7000

Code | Codice  
UB-7000  
Shape | Forma  
Comfort  
Colour | Colore  
White | Bianco



7000U

Code | Codice  
UB-7000U  
Shape | Forma  
Design  
Colour | Colore  
White | Bianco



M400S

Code | Codice  
UB-M400S  
Shape | Forma  
Standard  
Colour | Colore  
White | Bianco



M400

Code | Codice  
UB-M400  
Shape | Forma  
Comfort  
Colour | Colore  
White | Bianco



M400U

Code | Codice  
UB-M400U  
Shape | Forma  
Design  
Colour | Colore  
White | Bianco





**SAVE WATER**  
**SAVE LIFE**



**PUBLISHED BY**

SAMHONG TECH CO., LTD.  
2F, EUNSUNG BUILDING 53-8,  
CHEONGDAM-DONG, GANGNAM-GU SEOUL KOREA 135-763

Tt +82-2-3449-2343

Ft +82-2-3445-1686

Infor@isdongseo.co.kr

www.samhongtech.co.kr

**COPYRIGHT**

SAMHONG TECH CO., LTD.

**CONCEPTION**

NEW LINE S.R.L. | USPA EUROPE S.R.L.  
www.newlinetalia.com

**EDITING AND DESIGN**

CREOVISUALDESIGN  
www.creovisualdesign.com

**PRINTED BY**

ITALGRAFICA NOVARA  
www.italgrafica.net

Sold and Distributed in the United Kingdom by:

**Kaizen Solutions EU Limited**

**Gade View Hall**

**Hemel Hemstead Road**

**Nr Berkhamsted**

**HP4 1QR**

**United Kingdom**

**Tel:01442 843120**

**www.bidet-shower.co.uk**

SAMHONG TECH CO., LTD. reserves the right to change products shown in this catalogue at any time without prior notice. The figures and data quoted are intended as guidance only.

SAMHONG TECH CO., LTD. si riserva il diritto di apportare in qualsiasi momento modifiche o variazioni ai prodotti presenti in questo catalogo senza preavviso. I dati e le raffigurazioni riportate sono da intendersi come indicative.

