



Operating Instruction Manual

UB-7000

UB-7235 / 7220 / 7210



- *Thank you for purchasing this USPA product.*
- *You are kindly requested to read carefully this operation manual for proper use of this appliance with due attention.*
- *Please save this manual and place in an easily accessible location.*
- *Please register warranty for proper service.*

**THIS UNIT WAS MANUFACTURED FOR HOUSEHOLD USE ONLY.
READ ALL OPERATING INSTRUCTIONS BEFORE INSTALLATION.**

Notes

- 1. This product should be installed according to this manual.*
- 2. Please read this manual carefully and install properly.*
- 3. Please save this manual and place in an easily accessible location.*
- 4. Do not attempt to service this appliance yourself. Doing so could void the warranty*

Table of Contents

PREPARATION

1. IMPORTANT SAFEGUARDS	1
2. CAUTIONS BEFORE INSTALLATION	2
3. IDENTIFICATION	3
4. SAFETY INFORMATION (DANGER)	4
5. SAFETY INFORMATION (WARNING)	6

HOW TO USE

6. HOW TO USE	8
7. HOW TO CLEAN	10
8. MAINTENANCE	11

INSTALLATION

9. HOW TO INSTALL	12
--------------------------	-----------

ETC

10. BEFORE CALLING FOR SERVICE	14
11. SPECIFICATIONS	14
12. WARRANTY	15

1 Important Safeguards

1 READ ALL INSTRUCTION BEFORE USING

DANGER - To reduce the risk of electric shock:

1. Do not place or store this appliance where it can fall or be pulled into a tub or sink
2. Do not place in, or drop into water or other liquid.
3. Do not reach for a product that has fallen into water. Unplug immediately.

WARNING - To reduce the risk of burns, electric shock, fire or injury to persons.

1. Close supervision is necessary when this appliance is used by or near the very young, the elderly or in invalid. Children should not be permitted to use or touch this appliance without the supervision of an adult.
Be sure to adjust the temperature of the toilet seat for the elderly, those who are incapacitated, or people with sensitive skins.
2. Use this appliance only for its intended purpose as described in this manual. Do not use attachments not recommended by the manufacturer.
3. Never operate this appliance if it has a damaged cord or plug, if it is not working properly, if it has been dropped, damaged or dropped into water.
4. Install the unit properly by following the installation procedure.
5. Only authorized persons can install or repair the unit. Do not attempt to service this appliance yourself. Doing so could void the warranty.
6. Keep the cord away from heated surfaces.
7. Never drop or insert any objects into any opening or hose.
8. Do not use outdoors. Do not use aerosol or oxygen spray products on the unit.
9. Always follow the grounding instruction in this manual before plugging in the unit.
10. If the supply cord is damaged, it must be replaced by the manufacturer, its service agent or similarly qualified persons in order to avoid a hazard.

SAVE THESE INSTRUCTIONS

2 Cautions before installation

1. NOTE THE FOLLOWING IMPORTANT POINTS

1. Do not install in a location where water might be splashed on this appliance or in a location exposed to such excessive moisture that condensation forms on the products surface.
2. To avoid damage to electronic components due to high levels of humidity, provide adequate ventilation by opening a window and/or door when bathing. You may find operating an exhaust ventilating fan during these times of high humidity beneficial
3. Use a water supply having a water pressure 0.05Mpa~0.75Mpa.
4. Connect the product to a pipe carrying portable water. Do not connect to an industrial water line or other water supply that does not carry water of drinking quality.
5. In areas where freezes in pipes in winter make arrangements to keep the pipes warm. The water remaining in the unit may sometimes freeze during storage in winter. In that case, warm the unit in the room before installation.
6. The thermal protector in the water tank may sometimes trip during storage or transportation in warm weather causing non-operation. In that case, cool the unit in the room before installation.
7. The rated power voltage is 220~240V / 50~60Hz.
8. Do not supply electrical power to the unit until the plumbing installation work has been completed; it could cause malfunction.



This marking shown on the product or its literature, indicated that it should not be disposed with other household wasted at the end of its working life. To prevent possible harm to the environment or human health from uncontrolled waste disposal, please separate this from other types of wastes and recycle it responsibly to promote the sustainable reuse of material resources.

Household users should contact either the retailer where they purchased this product, or their local government office, for details of where and how they can take this item for environmentally safe recycling.

Business users should contact their supplier and check the terms and conditions of the purchase contract. This product should not be mixed with other commercial waste for disposal

3 Identification

1. Main unit

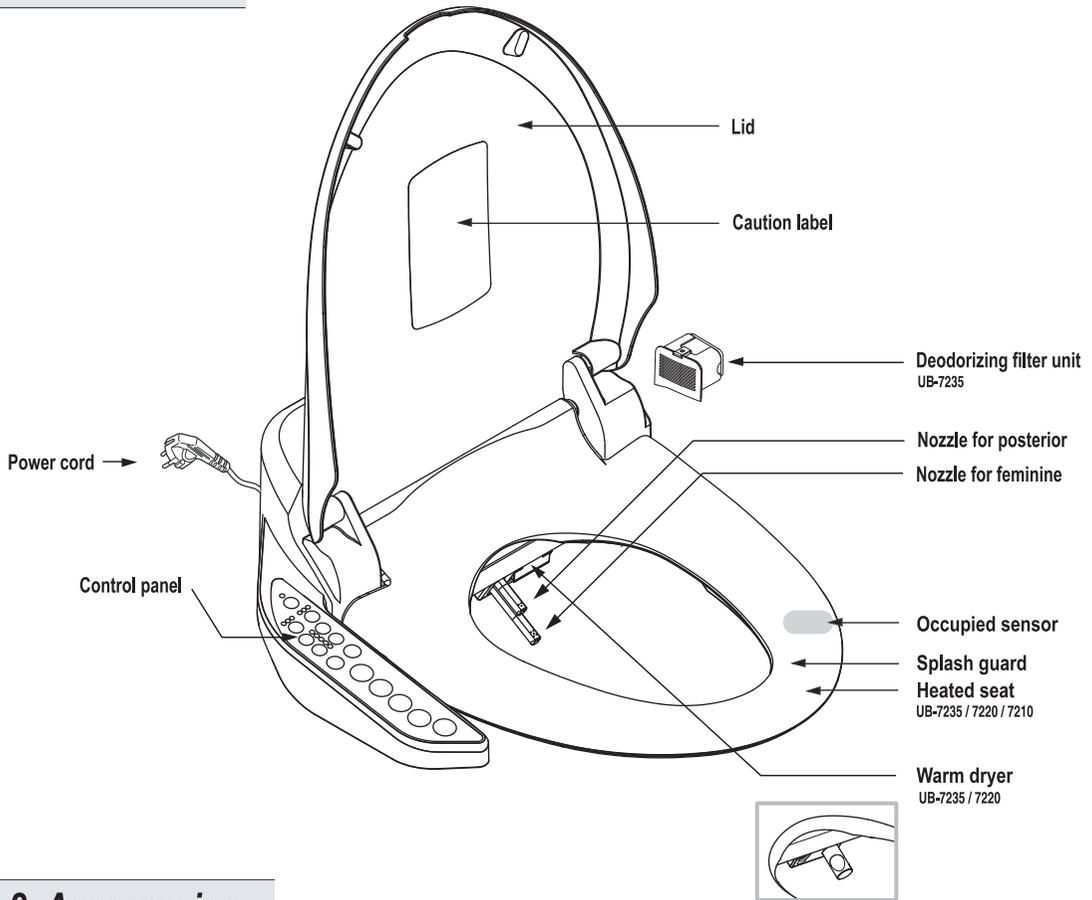

2. Accessories

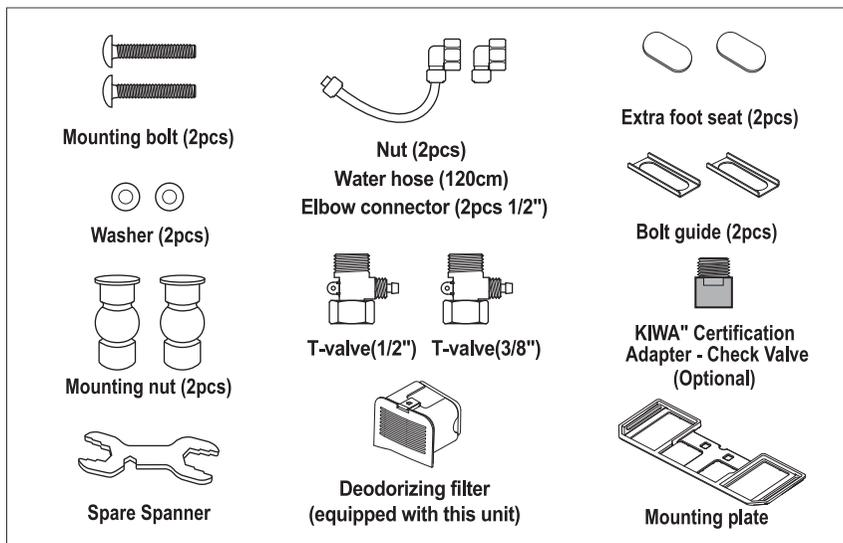

4 Safety Information (Danger)



DANGER

Please follow basic instructions to ensure the safe use of your appliance

Indicates a prohibited use of the appliance.

Indicates a required step in use of this appliance.

Prohibited

Do not throw Any firearms

Do not wash

Do not handle with wet hands

Do not disassemble

Ground connection

Required step



Meanings of symbols



PROHIBITED

Do not use a faulty or loose electric outlet or cord.

■ Doing so may result in a short circuit, electric shock or fire.

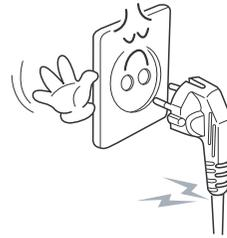

REQUIRED

Do not obstruct the warm air dryer outlet.

■ If the outlet is obstructed with any objects, it may result in fire

■ If the outlet is obstructed with hands, it may result in injury.



NO FIREARMS

Do not throw anything flammable into the toilet.

■ Doing so may result in fire



DO NOT WASH

Do not wash this appliance with water.

■ Doing so may result in fire or electric shock.



GROUND CONNECTION

Grounded wire or out let must be installed

■ If avoided, it may result in short shock or malfunction, if no grounded wire.

■ If no grounded plug is used, make sure to install grounded wire.





DANGER

Please follow basic instructions to ensure the safe use of your appliance



PROHIBITED

Do not use many appliances in a power strip

- Doing so may result in fire or damage.
- Be sure to use a dry and clean outlet.
- Do not use a faulty or loose outlet.

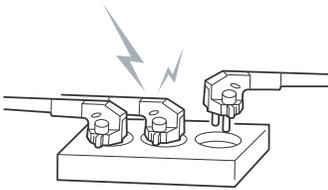

NO WET HANDS

Plug and unplug properly

- Do not plug or unplug with wet hands. It may result in injury or short circuit.
- Do not grab the cord when unplugging. Pull out the plug properly.

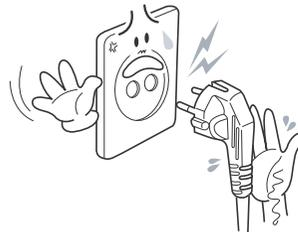

DO NOT DISASSEMBLE

Do not use when the seat and lid are disassembled

- Doing so may result in electric shock due to high voltage inside.



REQUIRED

Unplug when beeping or smelling strangely.

- Unplug right away.
- Contact your dealer where you bought this appliance.



DO NOT DISASSEMBLE

Do not disassemble, repair or modify this appliance.

- Doing so may result in fire or electric shock.



PROHIBITED

Use tap potable water only. (ground water)

- Not doing so may cause irritation or injury to your skin.

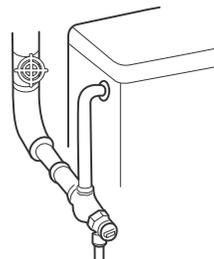

5 Safety Information (Warning)



Warning

Please follow basic instructions to ensure the safe use of your appliance.



PROHIBITED

Do not step on or place heavy objects on this appliance.

- Doing so may damage the unit.
- Do not step on a lid, seat or control panel to avoid injury or damage.



REQUIRED

Do not force the lid to close

- Doing so may cause malfunction.



REQUIRED

Be aware of urine splash on a nozzle or warm air outlet.

- Not doing so may result in smelling of products or failure.



PROHIBITED

Do not sit or lean against the lid or control panel

- Doing so may cause malfunction or breakage.



REQUIRED

Unplug while not using over extended period of time.



REQUIRED

Unplug while there is thunder or lightning.

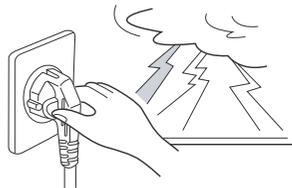



Warning

Please follow basic instructions to ensure the safe use of your appliance



Do not pull out water hose for cefully.

PROHIBITED

- Doing so may cause the water leakage.



Use this appliance on a toilet only.

PROHIBITED

- Not doing so may result in fire, injury or electric shock.



Improper use



Do not put a vase cup or small materials on this appliance.

PROHIBITED



Be aware of a low-grade burn.

REQUIRED

- It may result in a low-grade burn if sitting on the heated seat for a long time.
- Be aware if being used by the following:
 - Children, senior citizens, patients, or who cannot control the grade of temperature.
 - Sleeping pills users, or people who are on medication that causes drowsiness.
 - Who are drunk or very tired and may fall asleep while sitting on the unit.
- If injured in a low-grade burn, see a doctor immediately.



Unplug when cleaning

REQUIRED

- Not doing so may result in fire or electric shock.

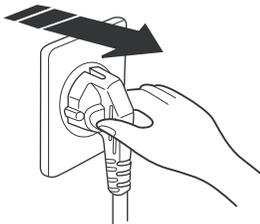

Use the low temperature for children and disabled.

REQUIRED

- If high temperature sets up, it may result in burn due to not recognizing the temperature.

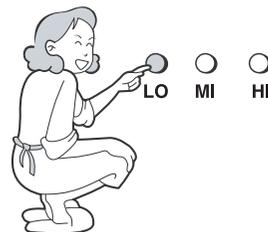

6 How to use

※ Caution

- All functions will be operational when the seat is occupied except Nozzle Cleaning.
- Before operating, ensure that water tank is filled up completely.

Stop

- Press "stop" to stop current operation.
- When a user stands up, all operation will stop automatically.

Cleansing

- Press "Cleansing" to clean your posterior. The function will stop in 60 seconds automatically.
- Press this button again to activate oscillation. The nozzle moves back and forth automatically to widen cleansing area.
- Oscillation wash stops if this button is pressed again.

Bidet

- Press "Bidet" for feminine wash. The function will stop in 60 seconds automatically.
- Press this button again to activate oscillation. The nozzle moves back and forth automatically to widen cleansing area.
- Oscillation wash stops if this button is pressed again.

Dry (Warm air) (UB-7235 / 7220)

- Press "Dry" after "Cleansing" or "Bidet". Nozzle type of dryer comes out. Operating time will be for 3 minutes.
- To alter the strength of air drying, press this button again.

IIP (intensive impulse pulsation) (UB-7235 / 7220 / 7210)

- Press "IIP" for easy defecation. Intensive water pulsation may help you to have easy defecation.
- It works for 60 seconds and stops automatically.
- Press "IIP" again for changing the pulsation mode.

Kids / Auto (UB-7235 / 7220 / 7210)

- Press "Kids/Auto" button one time to change all functions to be suitable for children.
- 1 minute for oscillation and 3 minutes for dry, level 1 of water pressure and level 5 of nozzle position will be set.
- This unit should be used under the supervision of an adult.
- Press "Kids/Auto" button two times to activate the automatic functions.
- The Auto-feature is done consecutively with "wash -> oscillation -> pulsation -> dry -> stop" for 4 minutes.

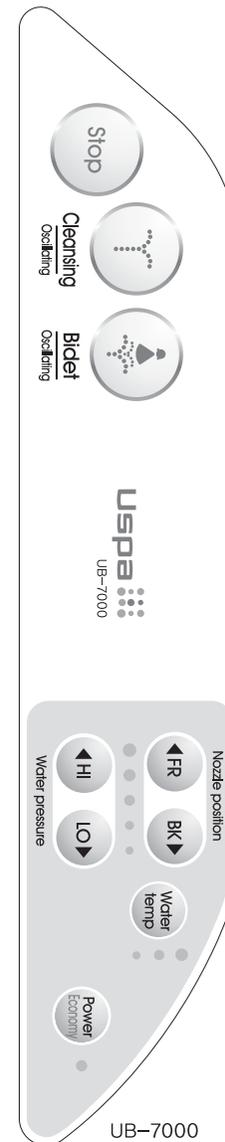
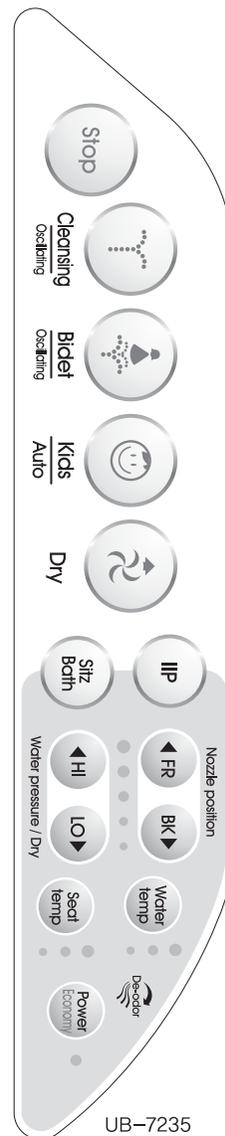

Self cleaning

- This appliance cleans its nozzles automatically before and after every use by rinsing off.

Self-diagnosis system

- This appliance has a self-diagnostic system, whenever the appliance has a problem(s), a LED of power on the unit will light on.
- Unplug and contact service center immediately.

Sitz Bath (Healthy Wash) (UB-7235 / 7220 / 7210)

- Press "Healthy wash" button to activate the warm and preferable water pressure for 3 minutes.
- If user presses "Healthy wash" button on posterior and bidet washing, healthy wash should be activated with warm and soft washing for 3 min

Automatic deodorization (UB-7235)

- When the appliance is in use, the deodorizer will work automatically. (max 20minutes)
- When a user stands up, it stops after 60seconds.

Nozzle position

- Nozzle position can be adjustable by pressing the nozzle position button
- Position will be initialized (level 3) after each of use.

Water pressure / Dry temperature

- Water spray pressure can be adjustable by pressing or in 5 levels.
- Temperature of dry can be adjustable by pressing or in 5 levels.
- Both levels will be initialized (level3) after each of use.

Temperature adjustment (water / seat)

- Temperature of seat and water can be adjustable.
- There are four levels, Room temp-Low-Medium-High.

Power / Economy

- Press "Power/ Economy" button to activate the power saving function. The unit will be in an economy mode immediately after use.
- In the economy mode shown the LED lamp with green color on the control panel, the temperature of water and seat will be kept to 30 degrees Celsius.
- When the unit is occupied during the economy mode, temperature will be returned to original setting levels and goes back to economy mode after use.
- Press "Power/ Economy" button two times to activate the Power ON/OFF condition with Red color LED lamp close by button. The green LED color is indicated on "Power save economy" mode and the red LED color is shown the "Power-On" condition. If led is off, the unit power should be off.

When the power is plugged in initially, nozzles for feminine wash and posterior will come out in turn.

7 How to clean

Nozzle cleaning

Caution Do not forcefully push or pull the nozzles, or bend them. It may result in failure. Make sure to use "Cleaning" button.

- 1 Make sure the occupied sensor is not activated. (not sitting on the seat or not place hands on the seat sensor part)
- 2 Press "FR" button, posterior nozzle comes out. Press "BK" button, feminine nozzle comes out.
Do not forcefully push or pull the nozzles, or bend them. Use a toothbrush or soft cloth to clean nozzles.
- 3 Press "Stop", "FR", "BK" and nozzles will return to stand-by mode. For extended period of time cleaning, unplug for safety.
- 4 Do not retract nozzles without a nozzle tip. It may result in malfunction.
- 5 Beware of lost tips and changes.

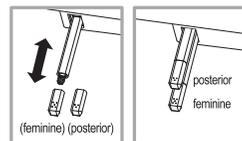
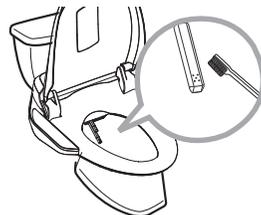

Strainer maintenance

This appliance will not operate properly if the strainer is clogged. Be sure to clean the strainer regularly.

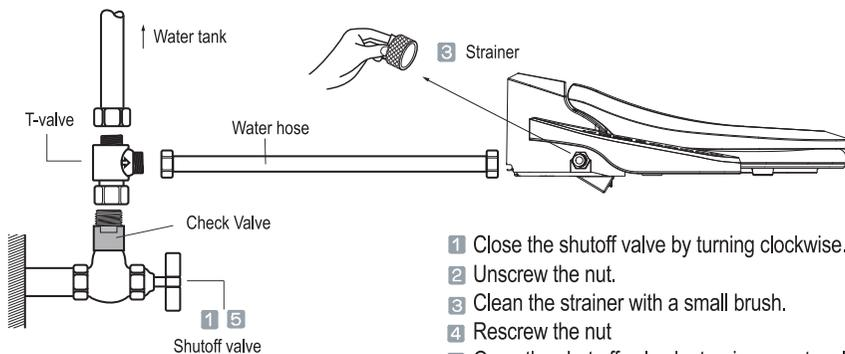

- 1 Close the shutoff valve by turning clockwise.
- 2 Unscrew the nut.
- 3 Clean the strainer with a small brush.
- 4 Rescrew the nut
- 5 Open the shut off valve by turning counter clockwise.

Cleaning the body

- 1 Regularly wipe off the body with a dry soft or sponge, or dampen with neutral detergent
- 2 Release the lid
 1. Pull left and up the left hinge part.
 2. Release the right hinge part (Be aware your fingers not to be caught)
- 3 For care of plastic body, do not use any cleansers which are not safe to use on toilet seats (toilet cleanser, home cleanser, bleach, benzene, paint thinner, cresol etc)

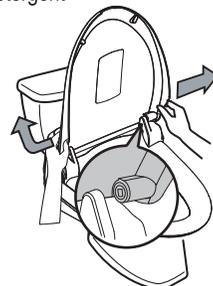

Draining water - while not using over extended period of time.

- 1** Unplug the power supply cord.
 ■ Not doing so may cause fire.

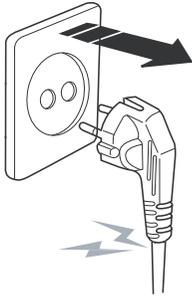

- 2** Close the shutoff valve.

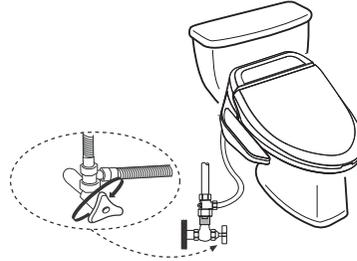

- 3** Remove the seat from installation plate.
 ■ Refer to the installation method.



- 4** Uphold the appliance and thoroughly drain the water by unscrewing the drain bolt.
 (beware of losing the drain bolt)

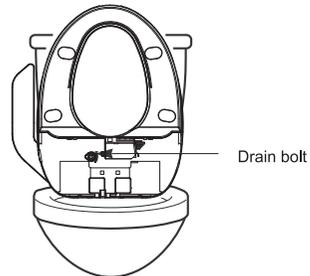

- 5** Screw the drain bolt and install the appliance.
 ■ Refer to the trial operation method in order to use this appliance again.

Preventing freezing

- 1** Make sure the power cord is plugged in properly.

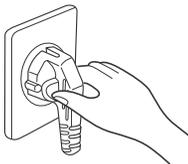

- 2** Set the temperature of water to low or middle.
 (Freezing can be prevented by thermal efficiency of water tank.)

- If there is no heating system in the toilet, wrap pipes with cloth or other materials.

- 3** Not using the unit for a long time in winter unplug and drain the water from the water tank and pipes thoroughly.

- Refer to the water drain method.

9 How to install



Do not plug in until installation is finished completely.
Not doing so may damage the appliance.

If electric work is needed, contact to the qualified electrician or serviceman only.

Remove the existing toilet lid and seat

1. Remove the nuts, washers and cone packings from the toilet seat mounting bolts in the back of the toilet.
2. Remove the toilet seat, lid and mounting bolts.
3. Keep them in case of installing again.

Install the appliance

Installation

How to mount the plate

Place the plate and guides over each mounting hole. Insert the mounting bolts through the plate and mounting holes, and slide cone packings and washers onto the bolts.

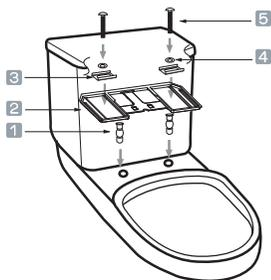

- 1 Mounting nut
- 2 Mounting plate
- 3 Bolt guide
- 4 Washer
- 5 Mounting bolt

How to attach and detach the unit



Slide the unit until it clicks into plate.



Lift the unit up and forward.

Toilet size (Elongated & Round front)

- The toilet dimensions must be within those shown below. Do not install this appliance on a toilet that does not meet those dimensional requirements.

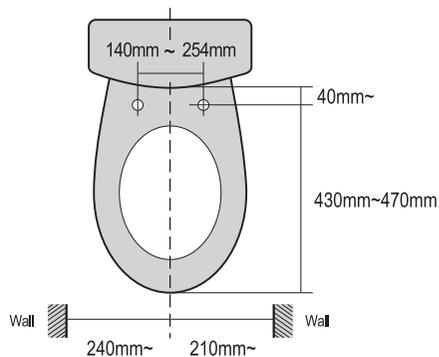

Occupied sensor

- This appliance is equipped with occupied sensor.
- Unit will not work unless seat is occupied.

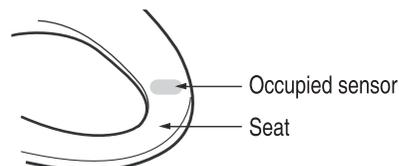

Connecting the water hose and grounding wire

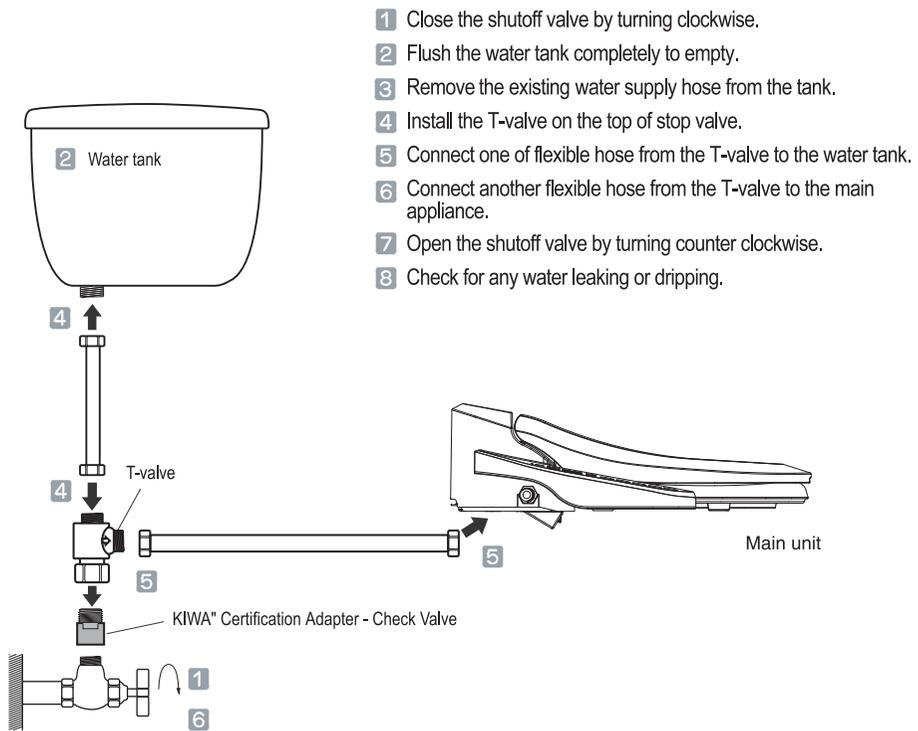

Trial operation

1. Preparation

Open the shutoff valve and check for any water leaking or dripping.
Plug the power cord into the outlet.
Press the "BIDET" or "CLEANSING", then water tank will be filled with water within 1 minute.
After the water tank has filled up, you will hear long buzzer sound.

2. Checking all functions

Cover the toilet bowl using the plastic wrapping sheet of the unit to prevent the washing water from being sprayed out of the toilet.
Then check for all function described in this manual

3. There are possibilities of water coming out that remains in the unit while heating.

10 Before calling for service

Problem	Possible cause	Solution
Completely fail to work	Is there a power cord outage? Is the power cord unplugged? Are you sitting on the seat correctly?	Check for a power cord failure or a tripped breaker Plug the power cord in properly Sit on the seat completely
Water does not spray	Is the water shutoff valve closed? Is the strainer clogged? Are the nozzles clogged?	Check for any water leaking or dripping Clean the strainer Clean the nozzles
Water is leaking or dripping	Check for all hoses are tightened properly	If water is still leaking or dripping, contact to your dealer
Seat, water or air is not enough warm	Is the temperature set to OFF? Is appliance used in economy mode such a cold weather?	Set the temperature Release the economy function

11 Specifications

Item	Elongated	UB-7235	UB-7220	UB-7210	UB-7000
	Round front	UB-7235S	UB-7220S	UB-7210S	UB-7000S
Standard power supply		220~240V / 50~60Hz 1660~1975W			220~240V / 50~60Hz 1605~1910W
Water supply	Way of connection	Direct connection to tap water			
	Water pressure	0.05MPa~0.75MPa			
Cleansing	Spray for cleansing	650 ± (100)mℓ /min			
	Spray for bidet	650 ± (100)mℓ /min			
	Water capacity	200 mℓ			
	Spray temperature	Room Temp~40°C(104 °F)			
	Heat capacity	1600W			
	Safety feature	Thermal switch, Temperature fuse, Floating switch			
Dry	Air temperature	Room Temp~60°C(140 °F)		None	
	Heater capacity	220~240V / 280~333W		None	
	Safety feature	Temperature fuse		None	
Heated seat	Seat temperature	Room Temp~40°C(104 °F)			None
	Heater capacity	220~240V / 55~65W			None
	Safety feature	Temperature fuse			None
Deodorization method		Catalytic filter	None		
Circuit breaker		Within 15mA 0.03 second			
Length of power cord		1.5m			
Dimensions	Elongated	(W)466mm X (L)520mm X (H)157mm		(W)18.34inch X (L)20.47inch X (H)6.18inch	
	Round front	(W)466mm X (L)490mm X (H)157mm		(W)18.34inch X (L)19.29inch X (H)6.18inch	
Weight		4.6Kg(10.14lbs)		4.4Kg(9.7lbs)	

WARRANTY

USPA Personal Hygiene Appliance Limited Warranty

- We warrant our products to be free from manufacturing defects under normal use and service for a period of two(2) years from date of your purchase. Only the ORIGINAL PURCHASER you may make a claim under this limited warranty .
 - Our obligation to you under this warranty is limited to repair or replacement, at our option, of defective products or parts, provided that the products were properly installed and used in accordance with instructions. We reserve the right to make inspections in order to determine the cause of the defect. We will not charge for labor or parts in connection with warranty repairs or replacement. We are not responsible for the cost of removal, return and/or reinstallation of products.
 - This limited warranty does not apply to:
 - a) Damage or loss from fire, earthquake, flood, storm, etc
 - b) Damage or loss resulting from any unreasonable use, abuse, negligence or improper maintenance.
 - c) Damage or loss from improper installation, removal, repair, or modification.
 - d) Damage or loss resulting from sediment or other matters contained in your water system.
 - This warranty gives you specific legal rights.
 - For warranty or service information, please contact your dealer where you bought this appliance or us.
 - Only the original purchaser may submit a claim under this limited warranty. To activate your warranty, complete this form.
 - This limited warranty is our only warranty covering your product. Repair or replacement as provided under this warranty shall be the exclusive remedy available to you. We shall not be responsible for loss of the product or for other incidental, or consequential damage or expenses you may incur or for labor or other costs due to installation or removal, or cost or repairs by others, or for any other expense not specifically stated above. Except to the extent prohibited by appliance law, any implied warranties, including that of merchantability or fitness for use are expressly limited to the duration of this warranty.
- ※ Warning! We are not responsible or liable for any failure of or damage to this plumbing product component caused by in-tank bowl cleaners containing chlorine (calcium hypochlorite)
- ※ Note : The use of high concentration of chlorine related products can seriously damage the fittings. This damage can cause leakage and serous property damage.

For more information, please contact your dealer or us.

Purchase Date _____ Purchase from _____
Invoice # _____ Amount Paid _____ Serial # _____
Address _____ City _____ State _____ Country _____ Zip _____
Phone _____ Fax _____ E-mail _____

Mail, email or fax the warranty form to:

YOUR LOCAL DEALER FIRST where you bought this appliance

if your dealer is unable to assist you,

SAMHONGTECH CO., LTD.

4th floor, Inhee Building, 52-1 Cheongdam-dong, Gangnam-gu, Seoul, Korea

TEL:82-2-3449-2341, FAX:82-2-3449-2309

E-MAIL : webbidet@samhongtech.co.kr <http://www.samhongtech.co.kr>

Great products for your healthy living!



SAMHONGTECH CO., LTD

4th floor, Inhee Building, 52-1
Cheongdam-dong, Gangnam-gu,
Seoul, Korea

TEL:82-2-3449-2341
FAX:82-2-3449-2309
[Http://www.samhongtech.co.kr](http://www.samhongtech.co.kr)

Ucare

UCARE S.R.L.

VIALE PAPINIANO, 44
20123 - MILANO
ITALY

<http://www.u-care.eu>
information@u-care.eu