

WASHLET
WHERE HYGIENE
MEETS COMFORT.



TOTO

OUR TECHNOLOGIES

WASHLET technologies



Warm water rinse

Individually regulated self-cleaning wand jet system



Heated seat

Individually regulated temperature



Deodoriser

Air-cleaning filter



Dryer

Warm air jet



Actilight

When combined with UV light, this zirconium coating has antibacterial properties and breaks down waste



ewater+

Electrolysed water with an antibacterial and cleansing effect

Conserve resources



Water-saving

Technology that conserves water

Hygiene technologies



Tornado Flush

Highly effective three-jet toilet flush



CeFiONtect

Special glaze with an extraordinarily smooth ceramic surface for unparalleled hygiene



Rimless design

Ceramic toilet bowl without a rim

Comfort technologies



Auto functions

Sensor-activated technologies

WASHLET

WHERE HYGIENE MEETS COMFORT.

WASHLETS

NEOREST AC	12
NEOREST EW	14
SG	16
GIOVANNONI	18
GL	20
EK	22

FUNCTIONS

CLEANING FUNCTIONS	26
HYGIENE FUNCTIONS	30
COMFORT FUNCTIONS	36
TOILET FUNCTIONS	38
ECO FUNCTIONS	40
OVERVIEW OF WASHLET FUNCTIONS	42
OVERVIEW OF TECHNICAL DATA	44
PLANNING DATA	46
WHAT YOU SHOULD KNOW	48

33 YEARS OF EXPERIENCE. FOR HYGIENE AND COMFORT



SOPHISTICATED TECHNOLOGY

TOTO has been producing WASHLETs longer than any other company, selling 33 million around the world so far. The WASHLET quickly gained popularity after being introduced in the 1980s. Today, WASHLETs are found in 65% of Japanese households.

This legacy gives our customers the confidence that TOTO WASHLETs have developed far past the prototype stage. Our WASHLETs are the product of over 30 years of expertise and represent the most advanced WASHLET technology available on the market.

MORE THAN JUST A SHOWER TOILET

Bathing culture has always played a major role in Japanese tradition, which is why this nation has such high standards for hygiene and comfort in the bathroom.

As the market leader in Japan, TOTO constantly works to improve its products – and has succeeded tremendously with the WASHLET. The WASHLET provides a very comfortable means of enhancing personal hygiene. At the same time, the WASHLET itself is extremely hygienic, featuring self-cleaning parts or technologies that make it difficult for dirt or waste to accumulate.

OUR PRINCIPLE

CLEAN TECHNOLOGY SINCE 1917

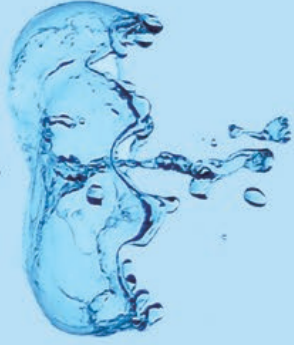

WASHLET

FOR THE ULTIMATE FEELING OF CLEAN.

THE BENEFITS OF CLEANSING WITH WATER.

Part of Japanese lifestyle for years, the shower toilet is still new to Europeans.

Cleansing with warm water after using the toilet provides an especially clean feeling. The special wand jet system is fully adjustable, allowing users to set the precise temperature, position and spray type for comfortable intimate cleansing. All easily soiled parts of the WASHLET stay clean and hygienic.



WHY A TOTO WASHLET? BECAUSE ONLY TOTO THOUGHT OF EVERYTHING.

- 1. ONLY TOTO OFFERS THE COMBINATION OF THE RIMLESS, HYGIENIC TOILET BOWL, TORNADO FLUSH AND WASHLET.**
- 2. ONLY TOTO HAS A SELF-CLEANING WASHLET.**
- 3. ONLY TOTO USES THE CLEANING AND ANTIBACTERIAL EWATER+ FUNCTION.**
- 4. ONLY TOTO OFFERS A WASHLET WITH SO MANY DIFFERENT WARM WATER CLEANING FUNCTIONS.**
- 5. ONLY TOTO HAS INTELLIGENT SURFACE SOLUTIONS, SUCH AS THE CEFIONTECT GLAZE FOR CERAMICS, AND THE SILICON-BASED ALLOY FOR THE SEAT AND WAND JET.**
- 6. ONLY TOTO HAS AN IMPRESSIVE 33 YEARS OF WASHLET EXPERIENCE YOU CAN COUNT ON.**

TOTO WASHLETS. THE IDEAL COMBINATION FOR PERFECT HYGIENE.



Rimless design

Ceramic toilet bowl without a rim



Tornado Flush

Highly effective three-jet toilet flush



CeFiONtect

Special glaze with an extraordinarily smooth ceramic surface for unparalleled hygiene



+ **washLÉT**
TOTO
CERAMIC

= **THE ULTIMATE**
FEELING
OF CLEAN

**TOTO
WASHLETS.
HYGIENE AND
COMFORT FOR
EVERY TASTE.**

WASHLETS OVERVIEW.



THE PREMIUM SOLUTION FOR TOTAL HYGIENE AND COMFORT.

This WASHLET is self-cleaning. A photocatalytic process breaks down all organic substances in the inside of the toilet bowl, making it practically impossible for waste, bacteria and mould to accumulate.

- ▶ Individually adjustable wand jet p. 26
- ▶ Self-cleaning Actilight function p. 31
- ▶ Antibacterial ewater+ feature p. 31
- ▶ Sensor-activated lid and flush p. 36
- ▶ Heated seat p. 36
- ▶ Dryer p. 36
- ▶ Filter p. 36
- ▶ Energy saver timer p. 41
- ▶ Energy saver auto p. 41

THE ULTIMATE SOLUTION WITH ADDED HYGIENE AND COMFORT.

This WASHLET features integrated ewater+ technology. Once the toilet is flushed, the inside of the bowl is sprayed with electrolysed water. This system, called ewater+ has an antibacterial and cleansing effect for the ultimate in hygiene.

- ▶ Individually adjustable wand jet p. 26
- ▶ Antibacterial ewater+ feature p. 31
- ▶ Sensor-activated lid and flush p. 36
- ▶ Heated seat p. 36
- ▶ Dryer p. 36
- ▶ Filter p. 36
- ▶ Energy saver timer p. 41
- ▶ Energy saver auto p. 41

THE ALL-ROUND SOLUTION WITH ADDED HYGIENE.

The SG collection WASHLET offers all standard TOTO WASHLET features. In addition to the characteristic warm water spray, odour-absorbing deodoriser and dryer, it has the new ewater+ feature with its antibacterial and cleansing effect.

- ▶ Individually adjustable wand jet p. 26
- ▶ Antibacterial ewater+ feature p. 31
- ▶ Sensor-activated lid and flush p. 36
- ▶ Heated seat p. 36
- ▶ Dryer p. 36
- ▶ Filter p. 36
- ▶ Energy saver timer p. 41
- ▶ Energy saver auto p. 41

WASHLET GIOVANNONI



WASHLET GL



WASHLET EK



THE DESIGN SOLUTION.

This WASHLET was designed by Stefano Giovannoni, making this product a unique combination of functional technology and outstanding Italian design. This WASHLET offers all of the standard functions – In a uniquely designed form.

- ▶ Individually adjustable wand jet p. 26
- ▶ Heated seat p. 36
- ▶ Filter p. 36
- ▶ Energy saver timer p. 41

THE SOLUTION WITH ADDED COMFORTS.

The GL WASHLET offers the performance and reliability of all TOTO WASHLETs, including the adjustable spray type, water pressure and temperature. Together with the added convenience of Remote control and air filter system, this WASHLET provides outstanding comfort and performance.

- ▶ Individually adjustable wand jet p. 26
- ▶ Heated seat p. 36
- ▶ Filter p. 36
- ▶ Energy saver timer p. 41

BEAUTIFULLY, SIMPLE AND EASY TO USE.

The EK WASHLET fits on all TOTO MH and NC collection toilets and offers all proven WASHLET technologies. The warm water spray ensures that every user leaves clean and fresh, while the control panel makes these technologies easy to use.

- ▶ Individually adjustable wand jet p. 26
- ▶ Heated seat p. 36
- ▶ Energy saver timer p. 41
- ▶ Energy saver auto p. 41



NEOREST AC WASHLET

The new NEOREST AC WASHLET is the first WASHLET that cleans itself completely. In addition to the proven WASHLET technologies, the new NEOREST WASHLET actively cleans the inside of the toilet bowl.

There are two versions of the WASHLET available – the NEOREST AC (with Actilight technology) and NEOREST EW (with ewater+ technology). They look the same, but work in different ways. The innovative Actilight technology destroys waste and bacteria. The ceramic toilet bowl features a special zirconium coating. The UV light integrated in the seat lid triggers a photocatalytic process when it hits the coating, breaking down all organic substances. This WASHLET also features the ewater+ function.

The WASHLET also has a sensor-activated lid which opens and closes by itself, an automatic flush and an adjustable dryer. The heated seat and deodoriser ensure that your visit to the bathroom is more pleasant. The wand jet system for personal cleansing is, of course, individually adjustable and provides unlimited warm water thanks to the continuous-flow water heater integrated in the WASHLET.

Of course, the NEOREST AC toilet seat isn't kept heated at all times. Instead, a memory function records the user's preferences for 10 days. The toilet then switches to energy-saving mode as required.

► Planning data p. 46





NEOREST EW WASHLET

The NEOREST EW is basically identical to the NEOREST AC – the only difference is that the EW does not feature the self-cleaning Actilight technology.

Before use, the NEOREST EW WASHLET sprays the inside of the toilet bowl with water – after all, less waste will stick to a wet surface. Once the toilet is flushed, the WASHLET sprays the bowl with electrolysed water. This ewater+ has an antibacterial and cleansing effect.

Like the NEOREST AC, the NEOREST EW has a sensor-activated lid which opens and closes by itself, an automatic flush and an adjustable dryer. The heated seat and deodoriser ensure that your visit to the bathroom is more pleasant. The wand jet system for personal cleansing is, of course, individually adjustable. All the functions, including the water jet temperature, pressure and position, can be conveniently adjusted using the remote control.

Of course, the NEOREST EW toilet seat isn't kept heated at all times. Instead, a memory function records the user's preferences for 10 days. The toilet then switches to energy-saving mode as required.

► Planning data p. 46



SG WASHLET

The SG WASHLET offers all features available in all other TOTO WASHLETs as well as the new ewater+ function. Once the toilet is flushed, the WASHLET sprays the toilet bowl with electrolysed water. This ewater+ has an antibacterial and cleansing effect for improved hygiene.

The WASHLET also features a dryer, heated seat, odour-absorbing filter, sensor-activated lid and a memory function to save personal settings for up to two users. The wand jet system for personal cleansing is, of course, individually adjustable and provides unlimited warm water thanks to the continuous-flow water heater integrated in the WASHLET. All functions can be conveniently activated using the remote control.

► Planning data p. 46







GIOVANNONI

This WASHLET is the product of an international design partnership between TOTO and renowned Italian designer Stefano Giovannoni, uniquely combining functional technology and high-quality Italian design. The Giovannoni WASHLET cleverly hides many of the unique features you'd expect from a TOTO WASHLET. It features the self-cleaning wand jet,

warm water spray, heated seat, air cleaning function and remote control to make hygiene and comfort natural aspects of your bath. The rimless design, Tornado Flush and special CeFiONtect glaze make this WASHLET complete – making it more than just a beautiful design object for your bathroom.

► Planning data p. 46



GL WASHLET



Thanks to the integrated wand jet system, the GL WASHLET makes it easy to adjust the position of the spray as desired. The adjustable water pressure and temperature combined with the air-cleaning filter system provides the highest possible comfort. The heated seat can be set to your chosen temperature, and includes an energy-saving function which can be set to three, six or nine hours. A remote control allows you to easily activate all these features. The soft-closing seat gently closes with a gentle tap – the ideal complement to this WASHLET. The GL WASHLET fits on all TOTO MH and NC collection toilets.

► Planning data p. 46







EK WASHLET

The European K is TOTO's entry-level WASHLET. It fits on all TOTO MH and NC collection toilets and offers our tried-and-tested WASHLET technology. The warm water spray ensures that every user leaves clean and fresh, while the control panel makes these technologies easy to use. The EK also features an energy-saving mode that turns the heated seat off for six or nine hours.

► Planning data p. 46



**WASHLET
FUNCTIONS.
CLEANSING,
HYGIENE
AND COMFORT
IN ONE.**

CLEANSING FUNCTIONS

EVERYONE HAS DIFFERENT NEEDS.

WARM WATER SPRAY.



Comfort spray

The comfort spray is designed to clean the rear intimate area. The water jet features pleasant, yet strong water pressure to target this specific area. The result: thorough cleansing without unnecessary splashing.



Soft comfort spray

This type of spray is also designed to clean the rear intimate area. It has a larger radius to cover more space. Low water pressure makes for a soft, comfortable spray.



Front Wash

The front wash consists of large, soft drops for comfortable intimate cleansing – for a clean, fresh feeling.



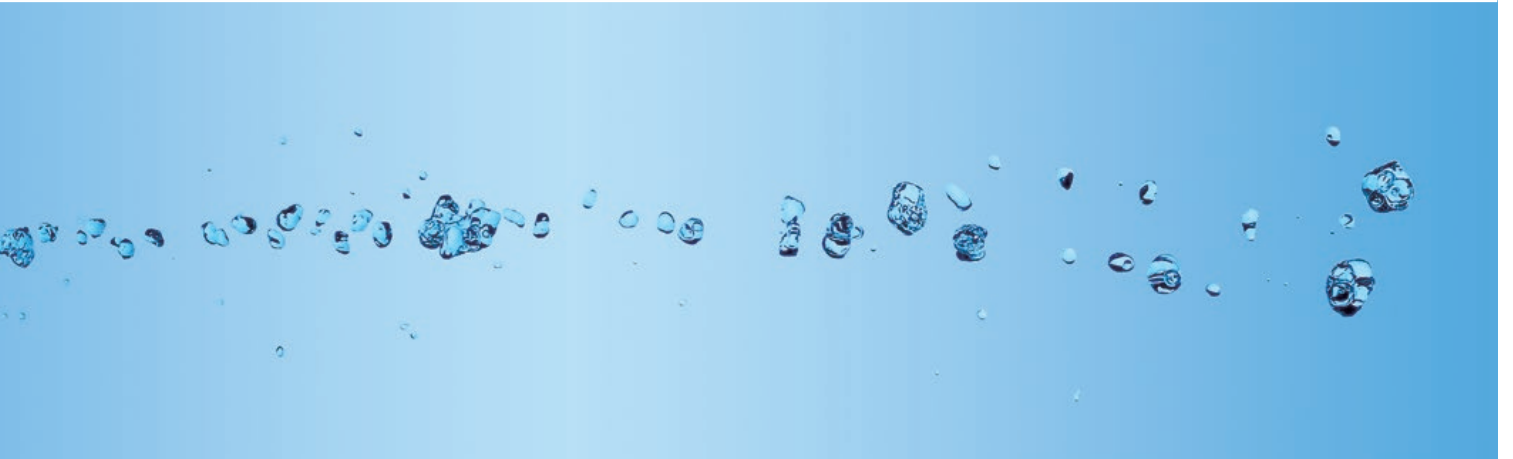

CLEANSING FUNCTIONS EVERYONE HAS DIFFERENT NEEDS.

WARM WATER SPRAY.



Oscillating comfort spray

The oscillating comfort spray can be activated in addition to the other spray types. The wand jet moves in and out for especially thorough cleansing over larger areas – for a feeling of ultimate clean.



Massage spray

You can also choose the massage function. The water pressure switches automatically between soft and hard.



Adjustable water pressure

The water pressure of the spray can be adjusted in five levels to meet the needs of each user.



Adjustable position

The position of the wand jet can be adjusted and adapted as required for each user – because everyone's different.



Continuous-flow water heater

Our NEOREST AC, EW and SG WASHLETs feature a continuous-flow water heater to provide unlimited water for intimate cleansing.

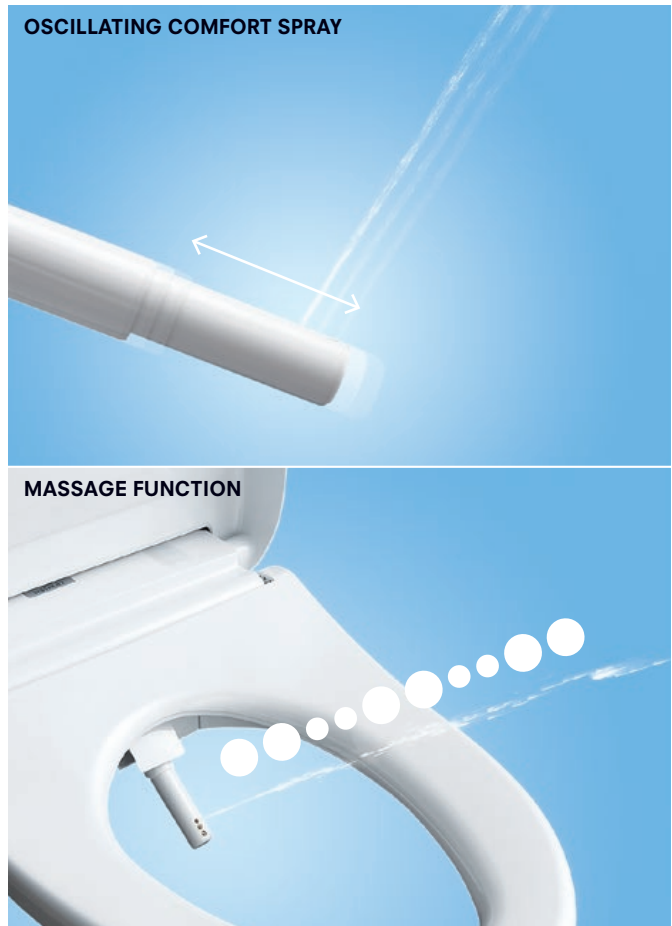





HYGIENE FUNCTIONS

ACTILIGHT & EWATER+

Actilight

The self-cleaning toilet bowl uses a photocatalytic process, which requires two components – UV light and the special zirconium coating. This is why the NEOREST AC features a UV light integrated into the lid of the toilet bowl. This automatically switches on once the sensor-activated lid is closed. The combination of UV light and zirconium coating breaks down all organic substances in the toilet bowl – the toilet truly cleans itself.

ewater+

The WASHLET sprays the toilet bowl with a fine mist of water prior to use because less waste and dirt will cling to a wet surface than a dry one. Once the toilet has been flushed, the WASHLET sprays the toilet bowl with electrolysed ewater+, which has an antibacterial and cleansing effect. It is absolutely safe for the environment and can be returned to the water cycle without worry.



HYGIENE FUNCTIONS

ACTILIGHT & EWATER+

EWATER+

The WASHLET initially sprays the toilet bowl with regular water, and then with electrolysed water following use. ewater+ has an antibacterial and cleansing effect.

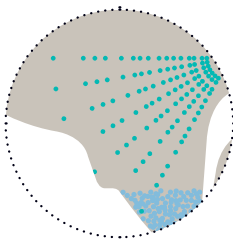
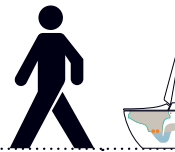
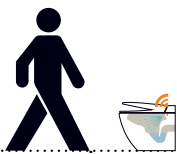

1. The sensor-activated lid opens automatically. The WASHLET sprays the toilet bowl with regular water prior to use.

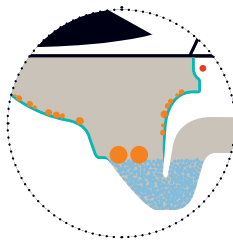

2. The water film makes it difficult for dirt and waste to stick to the surface. The deodoriser is activated.

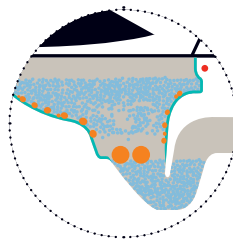

3. The Tornado Flush effectively cleans the toilet with a powerful whirlpool of water from three jets.

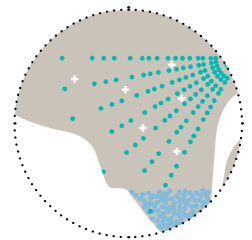

4. After use, the WASHLET sprays the bowl with electrolysed ewater+. This has an antibacterial and cleansing effect.

ACTILIGHT

The combination of zirconium-coated ceramic and UV light triggers a photocatalytic process that completely destroys waste and bacteria. The toilet literally cleans itself.

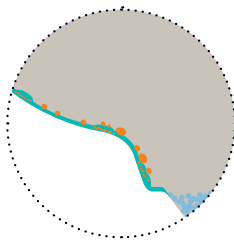

5. The ceramic features a special zirconium coating, which is especially durable and hydrophilic. Water easily washes away and eliminates the waste.

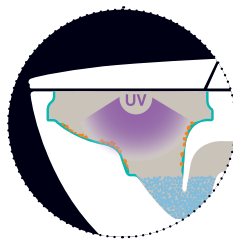

6. Once the toilet lid is closed, the integrated UV light turns on for an hour.

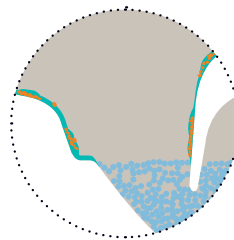

7. The interplay of the special coating and UV light releases activated oxygen, which breaks down waste without attacking the surface – a process that is completely safe for the environment.

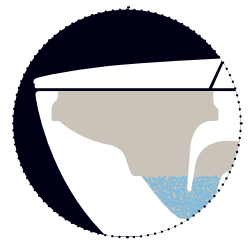

8. The Actilight function makes the toilet completely self-cleaning. If the toilet is not in use for eight hours, the WASHLET automatically sprays the bowl with e-water+ and the UV light in the lid switches on.

HYGIENE FUNCTIONS

IMPROVED HYGIENE FOR GREATER COMFORT.

Self-cleaning wand jet

The WASHLET automatically cleans the wand jet before and after each use. The wand jets are coated with a special silicone alloy, which makes them both antibacterial and extremely resistant to dirt. It is extremely difficult for anything to stick to the wand jet when wet – making it impossible for waste to accumulate. Thanks to this feature, TOTO is able to clean its wand jet system using only water – without any chemical additives. This also makes the system maintenance-free – the WASHLET does not need to be filled with substances to clean the jet.

The ewater+ WASHLET models use regular and antibacterial ewater+ to clean the wand jets.

Wand jet position

The jet extends at an angle, which keeps it from getting dirty. The soiled water falls directly into the toilet bowl at an angle of 43–53°, which keeps the jet clean.

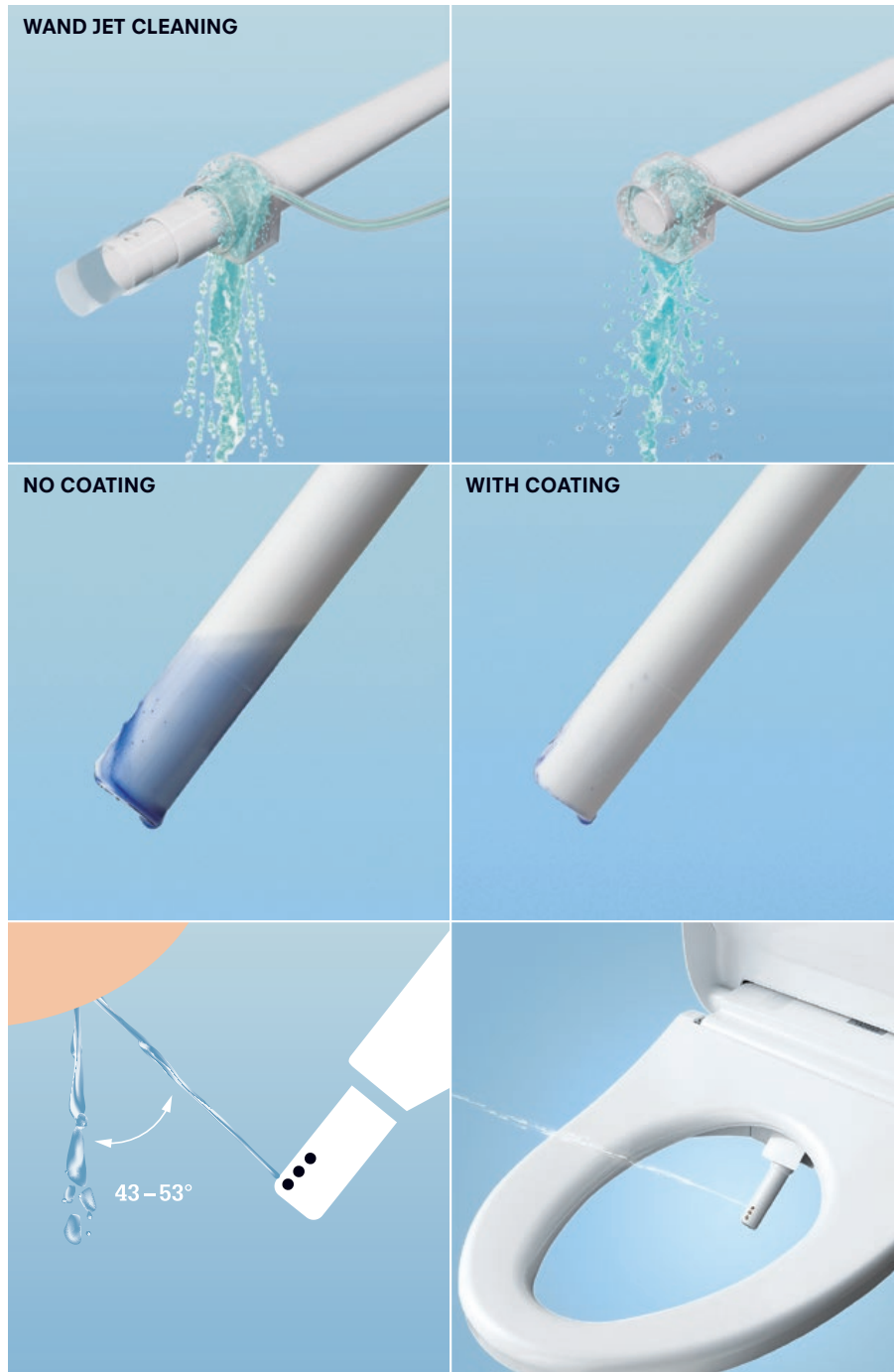

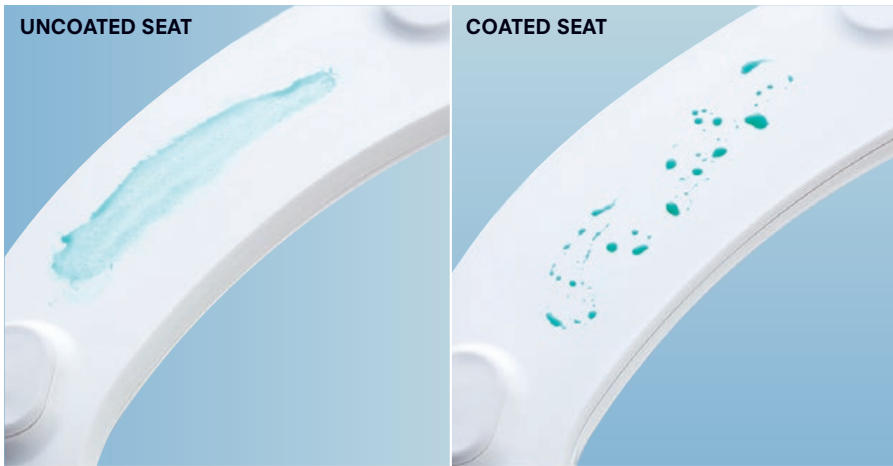

Clean toilet seat

The top and bottom of the toilet seat is coated with a dirt-resistant silicone alloy – for easier cleaning that lasts longer.

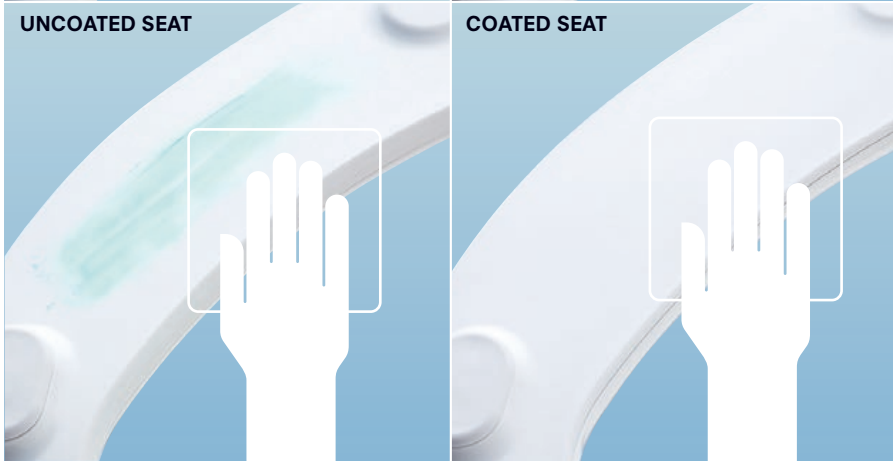

Easy to clean

The TOTO WASHLET can be removed from the toilet at the touch of a button and shifted forward for easy cleaning – even in places you cannot see.

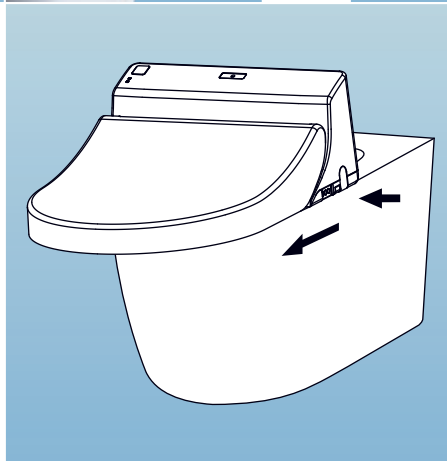

COMFORT FUNCTIONS

YOUR WELL-BEING IS OUR TOP PRIORITY.

EASY AND CONVENIENT TO USE.

Sensor-activated features

The sensor-activated lid opens automatically when someone nears the WASHLET and closes after use. The NEOREST WASHLETs also have a sensor-activated flush.

Heated seat

The heated seat can be set to the desired temperature.

Remote control

The remote control makes all functions easy to use and adjust. Several models include a memory function to save preferred settings for up to two users.

Dryer

The individually adjustable dryer follows the warm water spray to ensure a dry, clean overall feeling.

Deodoriser

The deodoriser effectively cleans the air around the toilet using powerful filters. Air is drawn in, passing through an ionised carbon filter to eliminate unpleasant odours.

Side night lights

People who do not want to turn on the bright bathroom light at night can choose a model featuring nightlights on the sides. A soft light on the sides of the toilet provides enough brightness to see and also helps people fall asleep again more quickly.

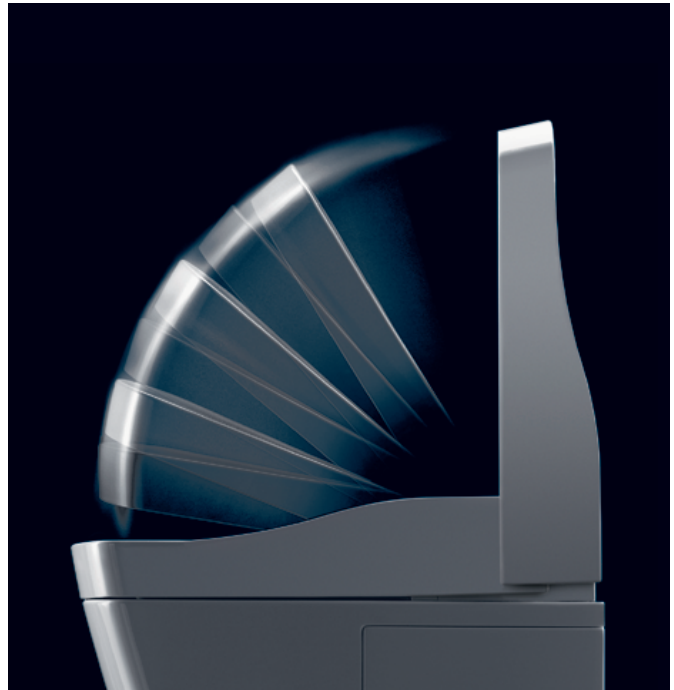



TOILET FUNCTIONS

PERFECT HYGIENE IS THE TOTO STANDARD.

BENEFITS OF TOTO CERAMIC.

Rimless design

Rimless toilet bowls are a standard feature of all TOTO toilets. As a result, there are no difficult-to-reach areas below the edge in which bacteria and waste can accumulate, for quicker, easier and more thorough cleaning.

CeFiONtect glaze

All TOTO ceramics are treated with the extremely durable and smooth CeFiONtect glaze. While conventional ceramics are normally coated (not glazed) and still have a rough surface, CeFiONtect provides an outstanding level of hygiene – making it practically impossible for dirt, waste and mould to accumulate. CeFiONtect-glazed surfaces can be cleaned using micro-fiber cloths without eroding the glaze over time.

Tornado Flush

An important feature of every TOTO toilet is the Tornado Flush. Three jets create a powerful whirlpool of water in the toilet bowl, like a tornado, effectively cleaning every inch. The power of the water is bundled and strengthened in a single direction. No spot in the toilet bowl is left untouched. As a result, it is practically impossible for bacteria, germs and waste to accumulate.

Hygiene Certificate

TOTO's ceramic toilet technologies have been recognised with the German Hygiene Certificate.





TOTO

NEOREST



ECO FUNCTIONS

FOR THE ENVIRONMENT AND SAFE DRINKING WATER



No chemical cleansers

All TOTO WASHLETs wands are self cleaning, using high pressure water jets, therefore they require no chemical additives for cleaning. Since the WASHLET uses only pure water for cleaning, it is not necessary to add any chemicals. This also makes the system maintenance free – the WASHLET does not need to be filled with chemical substances. The ewater+ WASHLET models use regular and antibacterial ewater+ to clean the wand jets – and require no maintenance.

Energy savers

TOTO WASHLETs feature two types of energy savers. Energy saver timer allows you to set a time at which the WASHLET is set to stand-by mode. With energy saver auto, the WASHLET records its users' habits and automatically selects the best time for stand-by mode.

EN 1717

standard for drinking water safety

Toilet water is rated as a hazard class 5 liquid in accordance with EN 1717. This standard describes the necessary precautions that a device must fulfil in order to secure the quality of drinking water. All TOTO WASHLETs are intrinsically safe and have a family A, type B backflow prevention device in line with DIN EN 13077. This keeps non-potable water from flowing back into drinking water systems without any additional installation required.

OVERVIEW OF WASHLET FUNCTIONS

NEOREST AC



NEOREST EW



		NEOREST AC	NEOREST EW
CLEANSING FUNCTIONS	COMFORT SPRAY REAR	•	•
	COMFORT SPRAY REAR SOFT	•	•
	COMFORT SPRAY FRONT WASH	•	•
	OSCILLATING COMFORT SPRAY	•	•
	MASSAGE SPRAY	•	•
	ADJUSTABLE WATER PRESSURE	•	•
	ADJUSTABLE POSITION	•	•
HYGIENE FUNCTIONS	ACTILIGHT	•	
	EWATER+	•	•
	REMOVABLE WASHLET UNIT		
	SELF-CLEANING WAND JET	•	•
	SELF-CLEANING WAND JET WITH EWATER+	•	•
	DEODORISER – AIR-CLEANING FILTER SYSTEM	•	•
	COATED WAND JET *	•	•
	CEFIONTECT GLAZE	•	•
	RIMLESS DESIGN	•	•
	TORNADO FLUSH	•	•
	COATED TOILET SEAT (TOP AND BOTTOM) *	•	•
COMFORT FUNCTIONS	NIGHTLIGHT	•	•
	SENSOR-ACTIVATED LID	•	•
	SENSOR-ACTIVATED FLUSH	•	•
	SOFT-CLOSING SEAT		
	REMOTE CONTROL	•	•
	DRYER WITH ADJUSTABLE TEMPERATURE	•	•
	HEATED SEAT WITH ADJUSTABLE TEMPERATURE	•	•
	MEMORY FUNCTION FOR TWO PEOPLE	•	•
	MAINTENANCE-FREE	•	•
	CONTINUOUS-FLOW WATER HEATER	•	•
	ECO	ENERGY SAVER TIMER	•
ENERGY SAVER AUTO		•	•
NO CHEMICAL CLEANERS REQUIRED		•	•

* silicone-based alloy

OVERVIEW OF TECHNICAL DATA

NEOREST AC







NEOREST EW



	NEOREST AC	NEOREST EW	
WARM WATER SPRAY	COMFORT SPRAY FLOW RATE	0.27 to 0.43 l/min	0.27 to 0.43 l/min
	SOFT FLOW RATE	0.32 to 0.43 l/min	0.32 to 0.43 l/min
	LADY SHOWER FLOW RATE	0.29 to 0.43 l/min	0.29 to 0.43 l/min
	CONTINUOUS-FLOW WATER HEATER	●	●
	WARM WATER TANK		
	WARM WATER SUPPLY	unlimited	unlimited
	ADJUSTABLE WATER TEMPERATURE	30 to 40 °C	30 to 40 °C
	WATER TANK REHEATING TIME		
COMFORT	HEATED SEAT, INDIVIDUALLY ADJUSTABLE TEMPERATURE	28 to 35 °C	28 to 35 °C
	DEODORISER – FILTER SYSTEM PERFORMANCE	normal 0.09m ³ /min, power 0.16m ³ /min	normal 0.09m ³ /min, power 0.16m ³ /min
	DRYER WITH ADJUSTABLE TEMPERATURE	35 to 55 °C	35 to 55 °C
CONNECTIONS/PIPES	POWER OUTLET REQUIRED	●	●
	WATER CONNECTION PRESSURE	1 to 10 bar	1 to 10 bar
	POWER INPUT	1289–1527 W	1289–1527 W
	CONNECTION LIMITS	220–240 V/50 HZ	220–240 V/50 HZ
ECO	STAND-BY	choose 3, 6 and 9 hours	choose 3, 6 and 9 hours
	EN 1717 (DRINKING WATER SAFETY)	●	●

CERAMIC/WASHLET COMBINATIONS

	CERAMIC					
	NEOREST (with zirconium coating)	NEOREST (with CeFiONtect glaze)	SG	GIOVANNONI	MH	NC
WASHLET	●					
NEOREST AC	●					
NEOREST EW		●				
SG			●			
GIOVANNONI				●		
GL					●	●
EK					●	●

SG WASHLET	GIOVANNONI	GL WASHLET	EK WASHLET
			
0.27 to 0.43 l/min	0.29 to 0.55 l/min	0.29 to 0.55 l/min	0.29 to 0.6 l/min
0.32 to 0.43 l/min			
0.29 to 0.43 l/min	0.27 to 0.55 l/min	0.27 to 0.55 l/min	0.27 to 0.55 l/min
•			
	0.7 l	0.7 l	0.78 l
unlimited	up to 2 minutes	up to 2 minutes	up to 2 minutes
30 to 40 °C	30 to 40 °C	30 to 40 °C	35 to 40 °C
	approx. 10 min	approx. 10 min	approx. 10 min
28 to 36 °C	28 to 35 °C	28 to 35 °C	28 to 35 °C
normal 0.09m ³ /min, power 0.16m ³ /min	normal 0.09 m ³ /min, power 0.16m ³ /min	normal 0.09m ³ /min, power 0.16m ³ /min	
35 to 55 °C			
•	•	•	•
1 to 10 bar	1 to 10 bar	1 to 10 bar	1 to 10 bar
1289–1527 W	270–320 W	270–320 W	269–315 W
220–240 V / 50 HZ	222–240 V / 50 HZ	221–240 V / 50 HZ	221–240 V / 50 HZ
choose 3, 6 and 9 hours	choose 3, 6 and 9 hours	choose 3, 6 and 9 hours	choose 6 and 9 hours
•	•	•	•

NEOREST AC

incl. remote control

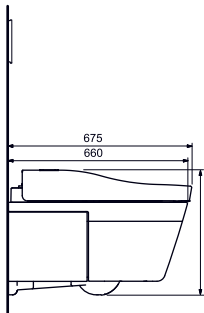
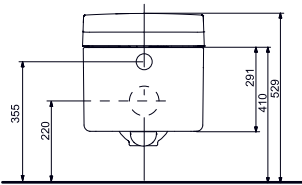
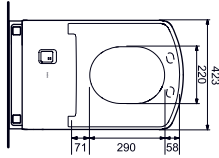

NEOREST EW

incl. remote control

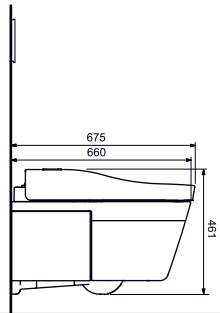
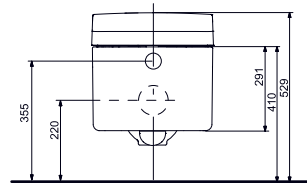
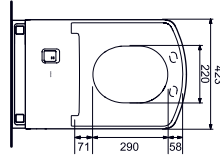

SG WASHLET

incl. remote control

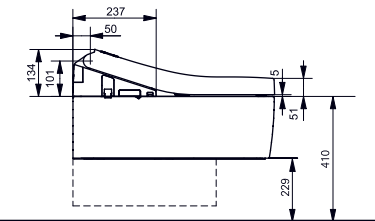
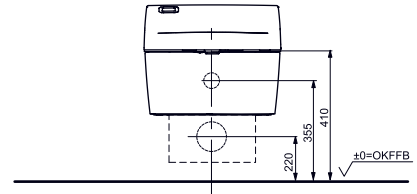
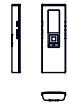
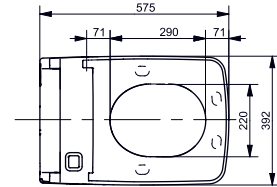

Technologies



- ▶ TCF996WG#NW1
- ▶ TCF996WSW#NW1 (CH)
- ▶ TCF996WGE#NW1 (UK)
- ▶ CW996P#NW1 WC
- ▶ Required accessories: push plate E00003, motor unit for flushing system E00004 and Pre-wall installation set T9300051 or T9300048
- ▶ Price category: ■■■■■

Technologies



- ▶ TCF994WG#NW1
- ▶ TCF994WSW#NW1 (CH)
- ▶ TCF994WGE#NW1 (UK)
- ▶ CW994P#NW1 WC
- ▶ Required accessories: push plate E00003, motor unit for flushing system E00004 and Pre-wall installation set T9300051 or T9300048
- ▶ Price category: ■■■■■

**Technologies
(in combination
with SG toilet)**



- ▶ TCF403G#NW1
- ▶ TCF403SW#NW1(CH)
- ▶ TCF403GE#NW1 (UK)
- ▶ CW512Y WC
- ▶ Price category: ■■■■■

GIOVANNONI WASHLET

incl. remote control

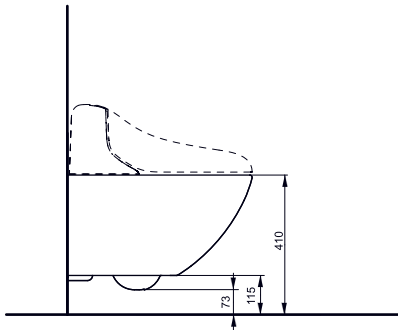
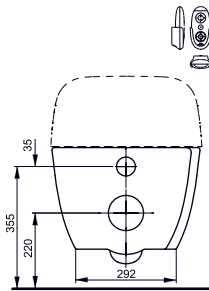
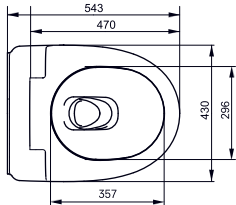

GL WASHLET

incl. remote control

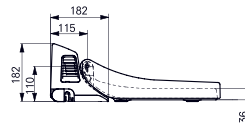
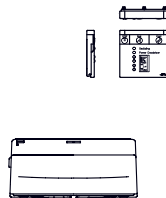
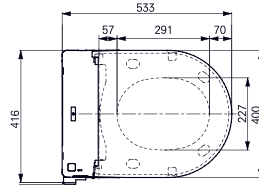

EK WASHLET

integrated control panel

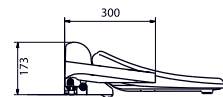
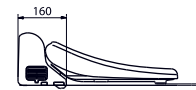
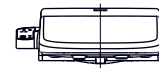
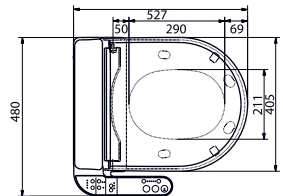

Technologies



- ▶ TCF892G
- ▶ TCF892SW (CH)
- ▶ TCF892GE (UK)
- ▶ CW882Y WC
- ▶ Price category: ■■■□□

Technologies



- ▶ TCF891G
- ▶ TCF891SW (CH)
- ▶ TCF891GE (UK)
- ▶ can be combined with all NC and MH toilets
- ▶ Price category: ■■■□□

Technologies



- ▶ TCF6402G
- ▶ TCF6402SW (CH)
- ▶ TCF6402GE (UK)
- ▶ can be combined with all NC and MH toilets
- ▶ Price category: ■■■□□

WHAT YOU SHOULD KNOW.

QUESTIONS AND ANSWERS.

WHAT TECHNICAL ASPECTS DO I NEED TO CONSIDER?

YOUR PLUMBER AND ELECTRICIAN NEED TO PROVIDE EXTRA POWER AND WATER CONNECTIONS IN ADVANCE.

CAN I UPGRADE MY TOILET TO A WASHLET?

IF YOU HAVE THE NECESSARY POWER AND WATER CONNECTIONS, IT IS POSSIBLE TO UPGRADE AT ANY TIME. PLEASE CONSULT THIS BROCHURE TO SEE WHICH WASHLETS FIT ON WHICH TOILETS.

WHO CAN INSTALL THE WASHLET?

TRAINED AND CERTIFIED PLUMBERS ARE FULLY CAPABLE OF INSTALLING WASHLETS.

WHERE CAN I TRY ONE?

USE THE WASHLET FINDER ON OUR WEBSITE (EU.TOTO.COM) TO SEE WHERE THE NEAREST PUBLICLY ACCESSIBLE WASHLET IS LOCATED.

HOW CAN I FIND THE CLOSEST PLUMBER OR RETAILER?

YOU CAN FIND RETAILERS AND CERTIFIED PLUMBERS ON OUR WEBSITE (EU.TOTO.COM).

WHY SHOULD I CHOOSE A TOTO WASHLET?

TOTO PRODUCES THE MOST TECHNICALLY SOPHISTICATED WASHLETS ON THE MARKET TODAY.

PUBLISHING DETAILS

PUBLISHED BY
TOTO Europe GmbH

info@totoeu.com
eu.toto.com

COPYRIGHT
© 2013, TOTO Europe GmbH

LAST REVISED
July 2013

CONCEPT AND EDITING
TOTO Europe GmbH
PLEX GmbH, Berlin

DESIGN
PLEX GmbH, Berlin



TOTO Europe GmbH

Zollhof 2

40221 Düsseldorf

Germany

info@totoeu.com

eu.toto.com